



The new Velleman Projects catalogue is
now available. Download your copy here:
www.vellemanprojects.eu



Modifications and typographical errors reserved - © Velleman nv. H8098'IP'2 (rev.1.0)
Velleman NV, Legen Heirweg 33 - 9890 Gavere.



Velleman N.V.
Legen Heirweg 33
9890 Gavere
(België)

Search product

Search Product

Navigation

- ▶ Home page
- ▶ Products
- ▶ Sales outlets
- ▶ Support
- ▶ Publications
- ▶ Jobs
- ▶ About us

News

NEW PIK193 LED CUBE

CubeAnimator software
available for download
here!!

Posted on 04-06-12

[Read more...](#)

Velleman Projects Newsletter

Are you an electronics enthusiastic or simply interested in our kits, mini-kits, modules and instruments?

Subscribe to our Newsletter and receive every month the latest news, new products & updates on Velleman Projects.

You will receive an e-mail. Click on the link in that e-mail to confirm your subscription.

Email:



Do you want to unsubscribe? Click on the 'unsubscribe' link in the footer of the last received newsletter from Velleman Projects.

- velleman.eu
- hpower.eu
- perel.eu
- vellemanprojects.com
- ad - modules - instruments
- velbus.eu
- forum.velleman.eu

Advertisements

DA01
DA02
A1

**K8055(N) / VM110(N)
Android Application**



Subscribing our newsletter?, visit www.vellemanprojects.eu

Log in Register

FAQ Search

It is currently Fri Sep 14, 2012 1:50 pm

View unanswered posts | View active topics

All times are UTC

Board index

	Topics	Posts	Last post
General			
Forum rules / Règlements du Forum Appt Frost / A lire en premier lieu Moderator: Velleman / Support	2	2	Wed Dec 26, 2008 10:44 am Velleman
Forum Administration Velleman En-ligne Forum Discussions Moderator: Velleman / Support	1	4	Thu May 03, 2012 1:22 pm Velleman
Velbus			
Velbus Home Automation Special section for our new Velbus Home Automation System (Domoticz) Moderator: Velleman / Support	404	3072	Tue Sep 11, 2012 1:11 pm Dimitri
Kits (Selling projects - Projects à vendre)			
General			
For other topics, general help and tricks, new ideas Moderator: Velleman / Support	331	438	Wed Sep 05, 2012 3:37 pm Velleman
Audio Hi-Fi Projects All audio related projects, amplifiers, valve amplifiers Moderator: Velleman / Support	557	2450	Fri Sep 14, 2012 9:52 am Velleman
PC Related Projects For projects that are connected to the PC like interface cards Moderator: Velleman / Support	1428	6940	Thu Sep 13, 2012 8:54 pm Mark
Microcontroller / Programmer / Experimenting Projects Here you can discuss PIC programming, example etc. Moderator: Velleman / Support	407	1745	Tue Sep 11, 2012 4:27 am Dimitri
Timers and Clocks All about our time related projects from regular clocks to programmable timers Moderator: Velleman / Support	281	894	Fri Sep 07, 2012 8:40 am Velleman
Home Projects Instruments related projects, from light drivers to remote control Moderator: Velleman / Support	626	2283	Fri Sep 14, 2012 12:00 pm Velleman



Participate our Velleman Projects Forum

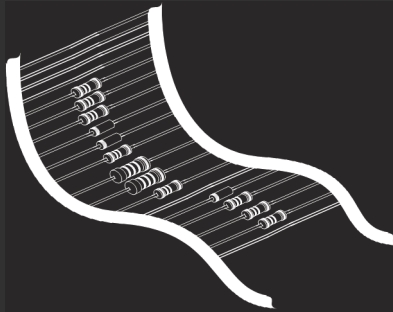

REMOVE THEM FROM THE TAPE ONE AT A TIME !

Included in
this kit

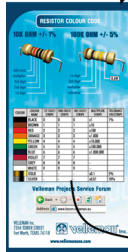

2. RESISTOR

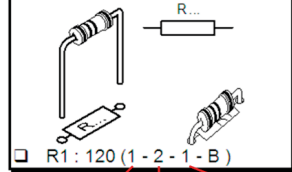

COLOUR	COLOUR NAME	1ST DIGIT/ STRIPE	2ND DIGIT/ STRIPE	3RD DIGIT/ STRIPE	MULTIPLIER STRIPE	TOL- 4TH!
Black	BLACK	0	0	0	x1	1%
Brown	BROWN	1	1	1	x10	
Red	RED	2	2	2	x100	
Orange	ORANGE	3	3	3	x1.000	
Yellow	YELLOW	4	4	4	x10.000	
Green	GREEN	5	5	5	x100.000	
Blue	BLUE	6	6	6	x1.000.000	

DO NOT BLINDLY FOLLOW THE ORDER OF THE COMPONENTS ONTO THE TAPE. ALWAYS CHECK THEIR VALUE ON THE PARTS LIST!

assembly hints

1. Assembly (Skipping this can lead to troubles !)

Ok, so we have your attention. These hints will help you to make this project successful. Read them carefully.



1.1 Make sure you have the right tools:

- A good quality soldering iron (25-40W) with a small tip.
- Wipe it often on a wet sponge or cloth, to keep it clean; then apply solder to the tip, to give it a wet look. This is called 'thinning' and will protect the tip, and enables you to make good connections. When solder rolls off the tip, it needs cleaning.
- Thin rosin-core solder. Do not use any flux or grease.
- A diagonal cutter to trim excess wires. To avoid injury when cutting excess leads, hold the lead so they cannot fly towards the eyes.
- Needle nose pliers, for bending leads, or to hold components in place.
- Small blade and Phillips screwdrivers. A basic range is fine.



☞ For some projects, a basic multi-meter is required, or might be handy



1.2 Assembly Hints :

- Make sure the skill level matches your experience, to avoid disappointments.
- Follow the instructions carefully. Read and understand the entire step before you perform each operation.
- Perform the assembly in the correct order as stated in this manual
- Position all parts on the PCB (Printed Circuit Board) as shown on the drawings.
- Values on the circuit diagram are subject to changes, the values in this assembly guide are correct*
- Use the check-boxes to mark your progress.
- Please read the included information on safety and customer service

* Typographical inaccuracies excluded. Always look for possible last minute manual updates, indicated as 'NOTE' on a separate leaflet.

1.3 Soldering Hints :

1. Mount the component against the PCB surface and carefully solder the leads

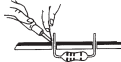

2. Make sure the solder joints are cone-shaped and shiny



3. Trim excess leads as close as possible to the solder joint



Features

- measure:
 - » peak power (fig.1)
 - » RMS power (fig.2)
 - » mean dB (fig.3)
 - » peak dB (fig.4)
 - » linear audio spectrum (fig.5)
 - » 1/3 octave audio spectrum (fig.6)
- auto or manual range selection
- peak-hold function
- speaker impedance selection
- language selection
- white backlit LCD
- easy panel mounting

Specifications

- power measurement into 2, 4 or 8 ohms + bridged amp option
- range: 300mW to 1200W @ 2 ohms
- sensitivity: -34dBu (15.5 mVrms)
- max. input level: 50Vrms @ 220k
- frequency range: 20Hz to 20kHz
- power supply: 12VDC / 75mA
- dimensions:
 - » display: 128 x 64pixels (46 x 23mm / 1.8 x 0.90")
 - » front panel: 98 x 51mm / 3.8 x 2"
 - » mounting depth: 35mm / 1.37"

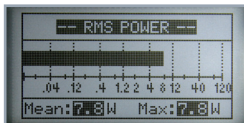

Fig.1

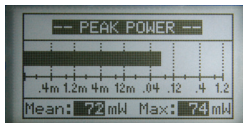

Fig.2

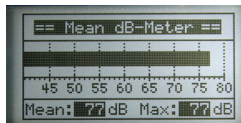

Fig.3

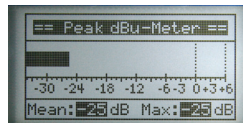

Fig.4

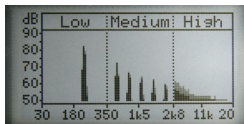
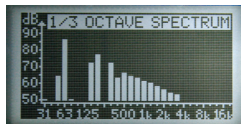

Fig.5



Fig.6



reversed

I. CONSTRUCTION

The audio analyzer consist of three parts: the basic module, the display module and the front panel. If required you can mount this kit into a housing, panel, ...

In this case use the display gap as a marker reference.

First we assemble the basic module.



Basic module

1 Jumper wire

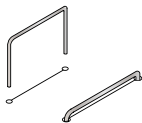

- J1
- J2
- J3
- J4
- J5
- J6

2 Resistors

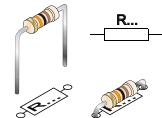

- R1 : 470 (4 - 7 - 1 - B)
- R2 : 1K (1 - 0 - 2 - B)
- R3 : 1K (1 - 0 - 2 - B)
- R4 : 220K (2 - 2 - 4 - B)

- R5 : 33K (3 - 3 - 3 - B)
- R6 : 33K (3 - 3 - 3 - B)
- R7 : 22K (2 - 2 - 3 - B)
- R8 : 750 (7 - 5 - 1 - B)
- R9 : 180K (1 - 8 - 4 - B)
- R10 : 2K2 (2 - 2 - 2 - B)
- R11 : 6K8 (6 - 8 - 2 - B)
- R12 : 6K8 (6 - 8 - 2 - B)
- R13 : 680 (6 - 8 - 1 - B)
- R14 : 3K3 (3 - 3 - 2 - B)
- R15 : 750 (7 - 5 - 1 - B)
- R16 : 5K6 (5 - 6 - 2 - B)
- R17 : 220 (2 - 2 - 1 - B)
- R18 : 22K (2 - 2 - 3 - B)

3 Diode

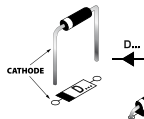

Watch the
polarity!

- D1 : 1N4007

4 IC-socket



Watch the position of the notch!



- IC1 : 8p
- IC2 : 28p

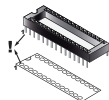

5 Coil

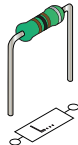

- L1 : 4700μH (4 - 7 - 2 - B)

6 Voltage regulator

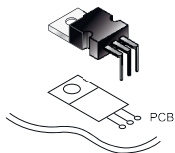

□ VR1 : LM317

7 Ceramic Capacitors

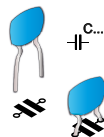

□ C...

□ C1 : 100nF (104)

□ C2 : 100nF (104)

□ C3 : 100nF (104)

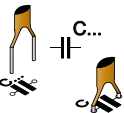

□ C...

□ C9 : 4.7nF (472)

□ C10 : 470pF (471)

□ C11 : 47pF (47)

⚠ C12, C13 & X1 are not mounted !

8 Pin header

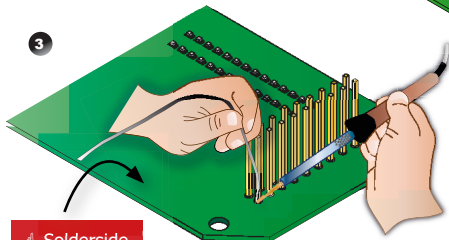
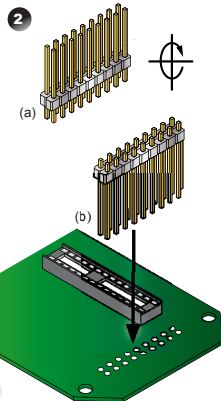
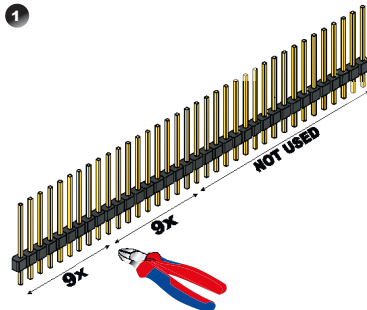

⚠ Solderside

9 Electrolytic Capacitor



Watch the polarity!

- C4 : 10 μ F
- C5 : 10 μ F
- C6 : 220 μ F
- C7 : 220 μ F
- C8 : 4,7 μ F
- C14 : 4,7 μ F

10 Board-to-wire connector

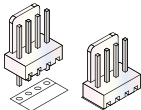

SK1

11 Push button

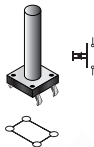

Mount the button on the solder side!



SW1

12 IC's

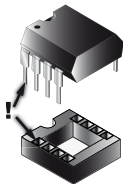

Watch the position of the notch!

IC1 : MCP6002-E/P

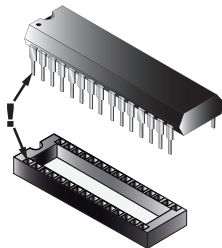

IC1 : VKVPA20
(programmed DSPIC33FJ32I/SP)

Display module

Follow these steps for correct soldering SMD components.

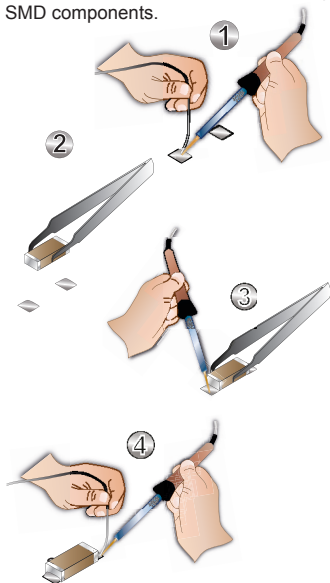

1 Capacitors

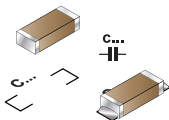

- | | |
|---|--|
| <input type="checkbox"/> C1 : 1 μ F | <input type="checkbox"/> C6 : 1 μ F |
| <input type="checkbox"/> C2 : 1 μ F | <input type="checkbox"/> C7 : 1 μ F |
| <input type="checkbox"/> C3 : 1 μ F | <input type="checkbox"/> C8 : 1 μ F |
| <input type="checkbox"/> C4 : 1 μ F | <input type="checkbox"/> C9 : 1 μ F |
| <input type="checkbox"/> C5 : 1 μ F | <input type="checkbox"/> C10 : 1 μ F |

2 Male header

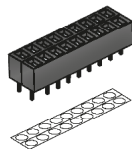

Mount the female connector on the component side, solder on the display side !

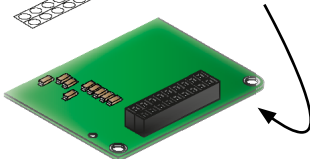

3 LCD

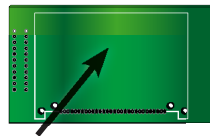

Be careful when soldering the LCD connections. Overheating will damage the LCD screen.

II. ASSEMBLY

1. Roughen the 4 bolts with a knife, a file or some abrasive paper so it will be easier to solder them to the front panel.
2. Assemble the unit but do not yet tighten the bolts (fig.1).

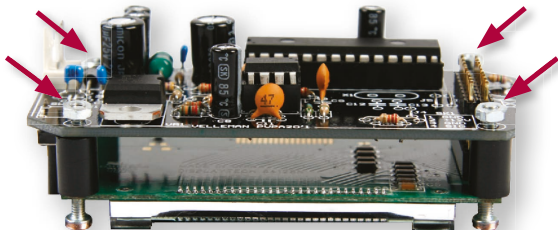

3. Position the unit onto the rear of the front panel with the display is centred in the cut-away. Temporarily fix the unit to the rear using non-permanent tape (fig. 2)

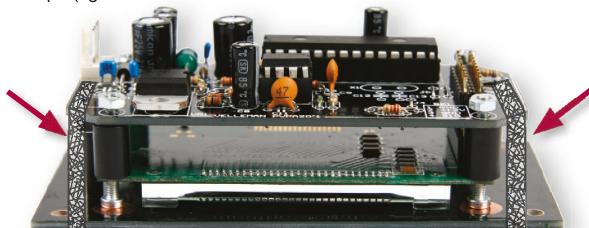
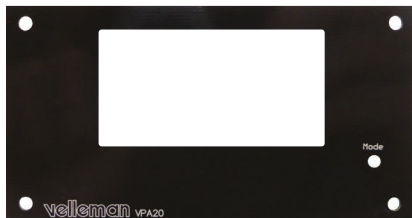

4. Solder 2 diagonal bolts to the front panel. Check if the display is still centred in the cut-away. Solder the remaining 2 bolts (fig. 3).

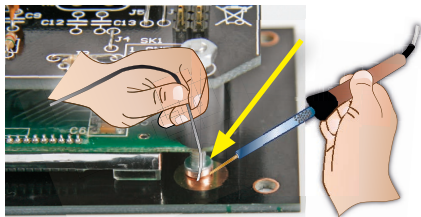

5. Now, fix the whole unit using the 4 nuts and remove the tape.

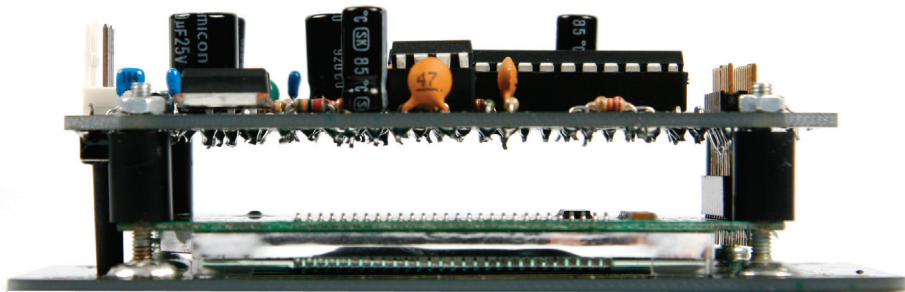

III. CONNECTION

EX. "BRIDGED" AMPLIFIER OR HIGH POWER RADIO

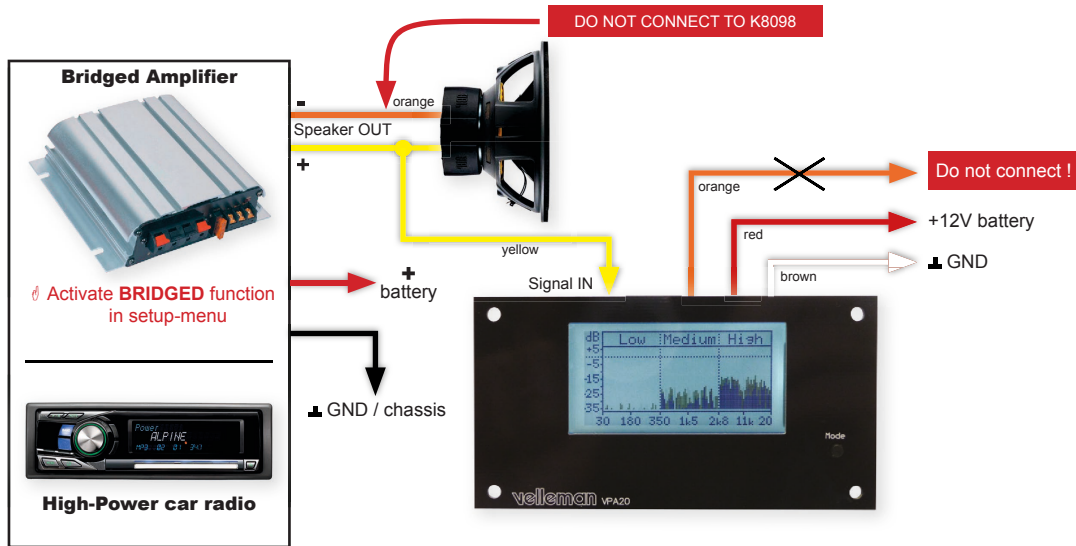

EX. CONNECTED TO SPEAKER OUTPUT

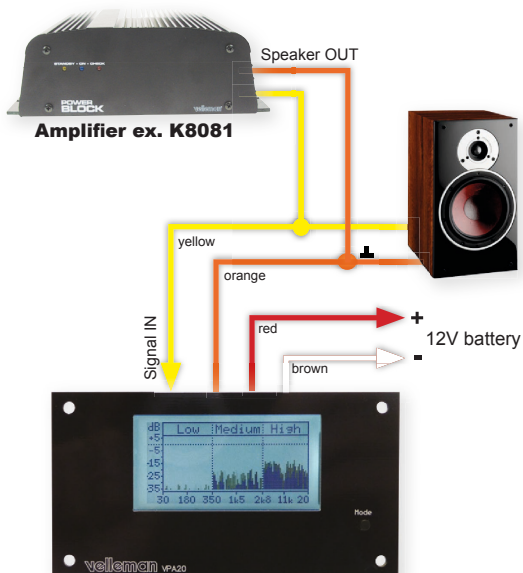

EX. CONNECTED TO SPEAKER OUTPUT

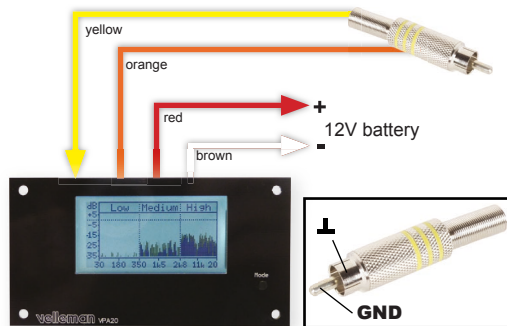

HINT FOR STEREO CONNECTION

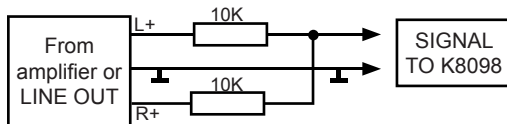

IV. USE

Short press on the 'mode' button: selecting a meter-display.

Long press on the 'mode' button: opening the set-up menu.

SET-UP MENU

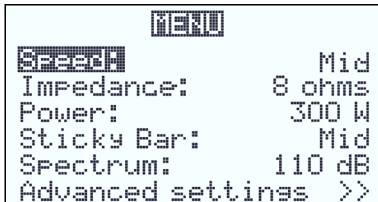

Access to the Set-up menu by a "long" push on the 'mode' button.

- **Short press:** changing settings
- **long press:** next function
- **Keep pressed:** save changes and exit

Speed: refreshing the screen (Fast - Mid - Slow)

Impedance: "2", "4" or "8" ohms for speaker output power calculation, in case the unit is connected to speaker output.

Power: "AUTO" range or a maximum value that depends on the chosen impedance.

• For impedance = 2: Possible choices are "1200 mW", "12W", "120W" or "1200W"

• For impedance = 4: Possible choices are "600 mW", "6W", "60W" or "600W"

• For impedance = 8: Possible choices are "300 mW", "3W", "30W" or "300W"

Sticky Bar: "Yes" or "No". When selected, small residual sticky bars appear also on the third octave spectrum screen.

Spectrum dB: "dBU" or "110 dB". (110 dB stands for the "Power dB" display which can range from 80dB to 110dB max, depending on the selected Power range).

Advanced settings: see pag. 16

ADVANCED SETTINGS

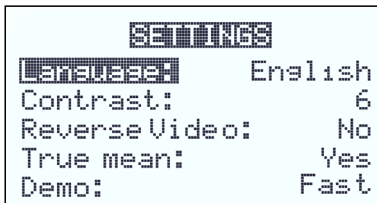

Language: UK / NL / FR / DE / ES

Contrast : choose a contrast between 1 - 20

Reverse video: normal or reverse display

True mean: Yes or no. If 'no' is selected then the display gives the integrated "peak values". If a pure sine wave is used both values will be the same.

Bridge amplifier: Turn on in case of in car use with high power radio or amplifier.

Demo: showing the different screen layouts, you can choose (slow - fast - off)

First open the set-up menu with a long press on the 'mode' button and choose the mode "advanced settings".

- **Short press:** changing settings
- **long press:** next function
- **Keep pressed:** save changes and exit

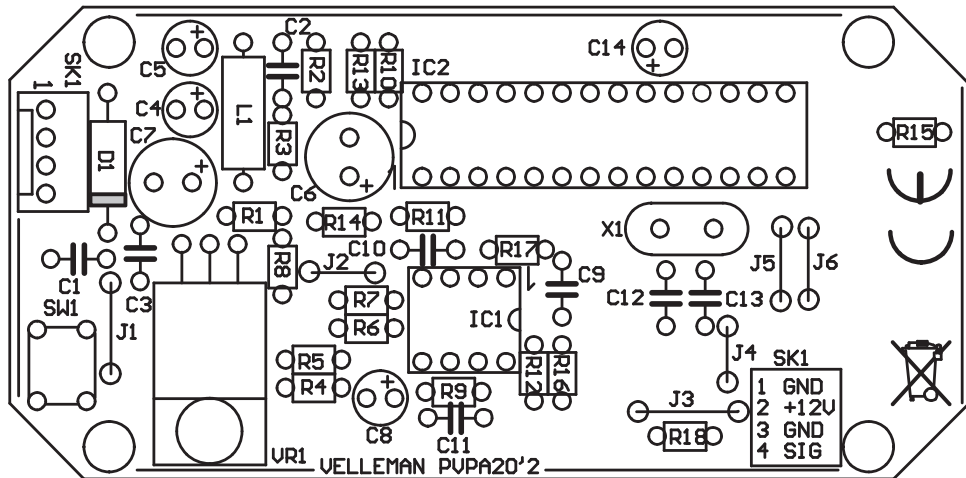

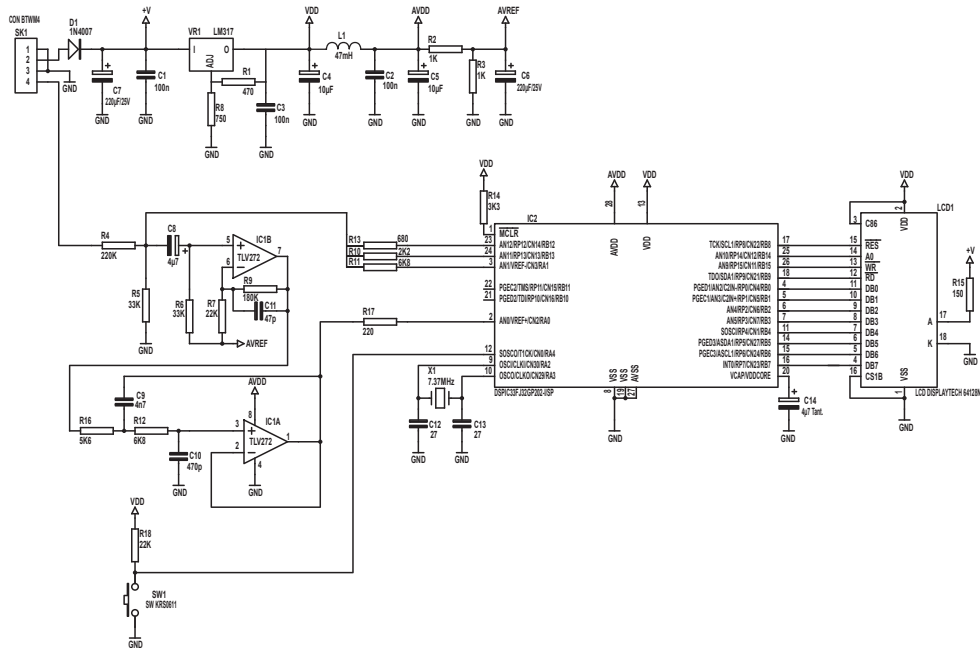

Leds and how to use them

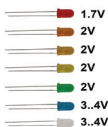

Leds feature a specific voltage drop, depending on type and colour. Check the datasheet for exact voltage drop and rated current !



Never connect leds in parallel

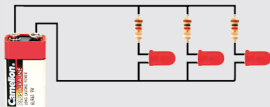
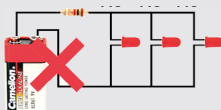

How to Calculate the series resistor:

Example: operate a red led (1.7V) on a 9Vdc source.

Required led current for full brightness: 5mA (this can be found in the datasheet of the led)

$$\frac{\text{Supply voltage (V) - led voltage (V)}}{\text{required current (A)}} = \text{series resistance (ohms)}$$

$$\rightarrow \frac{9V - 1.7V}{0.005A} = 1460 \text{ ohm}$$

closest value :
use a 1k5 resistor

Required resistor power handling=
voltage over resistor x current passed trough resistor

$$\rightarrow (9V - 1.7V) \times 0.005A = 0.036W$$

a standard 1/4W resistor
will do the job

LEDs in series:

Example: 3 x red led (1.7V) on 9V battery
Required led current for full brightness: 5mA
(this can be found in the datasheet of the led)

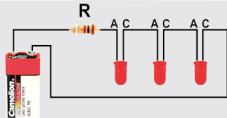

$$\frac{\text{Supply voltage (V) - (number of leds x led voltage (V))}}{\text{required current (A)}} = \text{series resistance (ohms)}$$

$$\rightarrow \frac{9V - (3 \times 1.7V)}{0.005A} = 780 \text{ ohm}$$

use an
820 ohm resistor

open collector outputs

An open collector output can be compared to a switch which switches to ground when operated

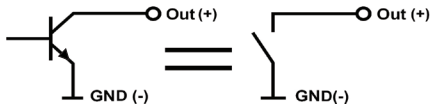

Example: How to switch an LED by means of an open collector output

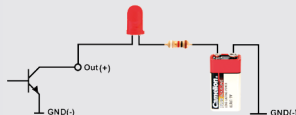



The new Velleman Projects catalogue is
now available. Download your copy here:
www.vellemanprojects.eu



Modifications and typographical errors reserved - © Velleman nv. H8098'IP'2 (rev.1.0)
Velleman NV, Legen Heirweg 33 - 9890 Gavere.