

JBC

www.jbctools.com



LISTA DE PRECIOS 17.1

Recomendados de venta al público



Compact line

pág. 4-5

CD-S

Estación Soldadora de Precisión



CD-B

Estación Soldadora



CA

Estación Soldadora con Aportación de Estaño



CP

Estación con Micro Pinza



CS/CV

Estaciones Desoldadoras



Modular line

Unidades de Control
pág. 20-21

DI

1 Herramienta



MS / MV

Módulos Desoldadores



DDE

2 Herramientas



MSE / MVE

Módulos Desoldadores



DME

4 Herramientas



Soportes
pág. 22-23

AD-SD



AP-SD



PA-SD



HT-SD



DS-SD



DR-SD



Herramientas
pág. 24-26

T210

T245

T470

Mango Soldadores



AP250

Soldador con Aportación de Estaño



PA120

Micro Pinza



HT420

Pinza



DS360

Micro Desoldador



DR560

Desoldador



Gama de Cartuchos
pág. 36-57

C210

C245

C250

C120

C420

C360

C560

Sistema de Limpieza
pág. 28-29



CL6166

Limpiador de puntas ESD



CLMS

Limpiador de puntas Júnior



CLMB

Limpiador de puntas Sénior

Premium line

DIR / DIT

Estaciones Soldadoras
pág. 6



AL

Estación Soldadora con Aportación Automática de Estaño
pág. 13



DSS / DIS / DIV

Estaciones Desoldadoras
pág. 7



PHS-K

Conjunto Pre calentador por Infrarojos
pág. 18

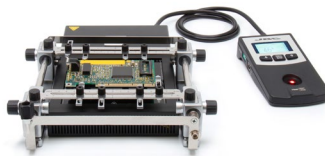

TE

Estación de Aire Caliente de Precisión
pág. 14



JT

Estación de Aire Caliente
pág. 14



PHB-K

Conjunto Pre calentador por Convección
pág. 19

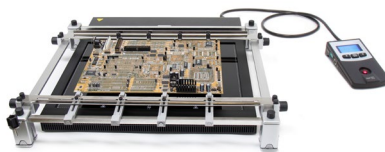

NASE

Nano Estación para Reparación
pág. 11



NANE

Nano Estación Soldadora
pág. 11



HDE

Estación Soldadora de Alta Potencia
pág. 10



DDSE / DDVE

Estaciones de Reparación
pág. 8



DMSE / DMVE

Estaciones de Reparación
pág. 9



RMSE / RMVE

Estaciones Completas de Reparación
pág. 10



Compact line

Estaciones Soldadoras

CD-2SE 230V · Estación Soldadora de precisión

395,00 €

Composición:

- Unidad de Control CD-E
- Mango de Precisión T210-A
- Cartuchos C210-001 y C210-008

Utiliza Cartuchos C210



CD-2BE 230V · Estación Soldadora

395,00 €

Composición:

- Unidad de Control CD-E
- Mango para aplicaciones generales T245-A
- Cartuchos C245-903 y C245-741

Utiliza Cartuchos C245



CA-2E 230V · Estación Soldadora con Aportación de Estaño

540,00 €

Para trabajos repetitivos y que requieran una mano libre

Composición:

- Unidad de Control CA-E
- Solador con Aportación de Estaño AP250-A
- Cartucho C250-403

Utiliza Cartuchos C250



Estación Soldadora y Desoldadora

CP-2E 230V · Estación con Micro Pinza

575.00 €

Composición:

- Unidad de Control CP-E
- Micro Pinza PA120-A
- 2 Cartuchos C120-002

Utiliza Cartuchos C120



Estaciones Desoldadoras

CS-2E 230V · Estación Micro Desoldadora con Bomba Eléctrica

1.080.00 €

Composición:

- Unidad de Control CSV-E
- Micro Desoldador DS360-A
- Punta C360-004
- Módulo Desoldador Eléctrico MS-A

Utiliza Puntas C360



CV-2E 230V · Estación Micro Desoldadora con Bomba Neumática

1.080.00 €

Composición:

- Unidad de Control CSV-E
- Micro Desoldador DS360-A
- Punta C360-004
- Módulo Desoldador Neumático MV-A

Utiliza Puntas C360



Premium line

Estaciones Soldadoras

DIR-2D 230V · Estación Soldadora de precisión

595,00 €

Composición:

- Unidad de Control **DI-D**
- Soporte **AD-SD**
- Mango de Precisión **T210-A**
- Cartucho **C210-001**
- Limpiador de Puntas ESD **CL6166**

Utiliza Cartuchos C210



DIT-2D 230V · Estación Soldadora

595,00 €

Composición:

- Unidad de Control **DI-D**
- Soporte **AD-SD**
- Mango para aplicaciones generales **T245-A**
- Cartucho **C245-903**
- Limpiador de Puntas ESD **CL6166**

Utiliza Cartuchos C245



Estaciones Desoldadoras

DSS-2D 230V · Estación Micro Desoldadora con Bomba Eléctrica

1.330,00 €

Composición:

- Unidad de Control **DI-D**
- Soporte **DS-SD**
- Micro Desoldador **DS360-A**
- Puntas **C360-002** y **C360-004**
- Módulo Desoldador Eléctrico **MS-A**
- Limpiador de Puntas **ESD CL6166**
- Juego de accesorios

Utiliza Puntas C360



DIS-2D 230V · Estación Desoldadora con Bomba Eléctrica

1.300,00 €

Composición:

- Unidad de Control **DI-D**
- Soporte **DR-SD**
- Desoldador **DR560-A**
- Puntas **C560-004**, **C560-005** y **C560-013**
- Módulo Desoldador Eléctrico **MS-A**
- Limpiador de Puntas **ESD CL6166**
- Juego de accesorios

Utiliza Puntas C560



DIV-2D 230V · Estación Desoldadora con Bomba Neumática

1.300,00 €

Composición:

- Unidad de Control **DI-D**
- Soporte **DR-SD**
- Desoldador **DR560-A**
- Puntas Puntas **C560-004**, **C560-005** y **C560-013**
- Módulo Desoldador Neumático **MV-A***
- Limpiador de Puntas **ESD CL6166**
- Juego de accesorios

Utiliza Puntas C560

* Es necesario aire comprimido externo



Premium line

Estaciones de Reparación

DDSE-2B 230V · Estación de Reparación con Bomba Eléctrica

1.575,00 €

Composición:

- Unidad de Control **DDE-B**
- Soporte **AD-SD** y **DR-SD**
- Mango para aplicaciones generales **T245-A**
- Desoldador **DR560-A**
- Cartuchos **C245-903** y **C245-906**
- Puntas **C560-004**, **C560-005** y **C560-013**
- Módulo Desoldador Eléctrico **MSE-A**
- Limpiador de Puntas ESD **CL6166**
- Juego de herramientas y accesorios

Utiliza Cartuchos C245 y Puntas C560



DDVE-2B 230V · Estación de Reparación con Bomba Neumática

1.575,00 €

Composición:

- Unidad de Control **DDE-B**
- Soporte **AD-SD** y **DR-SD**
- Mango para aplicaciones generales **T245-A**
- Desoldador **DR560-A**
- Cartuchos **C245-903** y **C245-906**
- Puntas **C560-004**, **C560-005** y **C560-013**
- Módulo Desoldador Neumático **MVE-A***
- Limpiador de Puntas ESD **CL6166**
- Juego de herramientas y accesorios

Utiliza Cartuchos C245 y Puntas C560

* Es necesario aire comprimido externo



Estaciones de Reparación

DMSE-2A 230V · Estación de Reparación de 4 herramientas con Bomba Eléctrica

1.800,00 €

Composición:

- Unidad de Control **DME-A**
- Soporte **AD-SD** y **DR-SD**
- Mango para aplicaciones generales **T245-A**
- Desoldador **DR560-A**
- Cartuchos **C245-903** y **C245-906**
- Puntas **C560-004**, **C560-005** y **C560-013**
- Módulo Desoldador Eléctrico **MSE-A**
- Limpiador de Puntas ESD **CL6166**
- Juego de herramientas y accesorios

Utiliza Cartuchos C245 y Puntas C560



DMVE-2A 230V · Estación de Reparación de 4 herramientas con Bomba Neumática

1.800,00 €

Composición:

- Unidad de Control **DME-A**
- Soporte **AD-SD** y **DR-SD**
- Mango para aplicaciones generales **T245-A**
- Desoldador **DR560-A**
- Cartuchos **C245-903** y **C245-906**
- Puntas **C560-004**, **C560-005** y **C560-013**
- Módulo Desoldador Neumático **MVE-A**
- Limpiador de Puntas ESD **CL6166***
- Juego de herramientas y accesorios

Utiliza Cartuchos C245 y Puntas C560

* Es necesario aire comprimido externo



Premium line

Estaciones Completas de Reparación

RMSE-2D 230V · Estación Completa de Reparación con Bomba Eléctrica

3.120,00 €

Composición:

- Unidad de Control **DDE-B** y JTSE-A
- Soportes **AD-SD**, **DR-SD** y **JT-SD**
- Mango para aplicaciones generales **T245-A** y Desoldador **DR560-A**
- Calefactor **JT-T2A**
- Lápiz Posicionador **T260-A**
- Cartuchos **C245-903** y **C245-906**
- Puntas **C560-004**, **C560-005** y **C560-013**
- Módulo Desoldador Eléctrico **MSE-A**
- Limpiador de Puntas **ESD CL6166**
- Juego de herramientas y accesorios
- *Pupitre

*(*ver composición del pupitre JT en página 15)*

Utiliza Cartuchos C245, Puntas C560 y Boquillas JN



RMVE-2D 230V · Estación Completa de Reparación con Bomba Neumática

3.120,00 €

Composición:

- Unidad de Control **DDE-B** y JTSE-A
- Soportes **AD-SD**, **DR-SD** y **JT-SD**
- Mango para aplicaciones generales **T245-A** y Desoldador **DR560-A**
- Calefactor **JT-T2A**
- Lápiz Posicionador **T260-A**
- Cartuchos **C245-903** y **C245-906**
- Puntas **C560-004**, **C560-005** y **C560-013**
- Módulo Desoldador Neumático **MVE-A****
- Limpiador de Puntas **ESD CL6166**
- Juego de herramientas y accesorios
- *Pupitre

*(*ver composición del pupitre JT en página 15)*

Utiliza Cartuchos C245, Puntas C560 y Boquillas JN

* Es necesario aire comprimido externo



Estación Soldadora para trabajos intensivos

HDE-2B 230V · Estación Soldadora de Alta Potencia

900,00 €

Composición:

- Unidad de Control **HDE-B**
- Soporte **HD-SD**
- Mango HD **T470-A**
- Limpiador de Puntas **ESD CL6166**
- No incluye cartuchos

Utiliza Cartuchos C470



Premium line

Nano estaciones

NASE-2B 230V · Nano estación de Reparación

1.040,00 €

Composición:

- Unidad de Control NAE-B
- Nano Soldador **NT105-A**
- Nano Pinza Estable **NP105-B**
- Set de Cartuchos (Ref. 0011568):
C105-101, C105-103, C105-107, C105-112
C105-105 (x2), C105-113 (x2)

Utiliza Cartuchos C105



N1738 · Manguitos

5,50 €

Manguitos para la Nano Pinza **NP105-A**



NANE-2B 230V · Nano estación Soldadora

970,00 €

Composición:

- Unidad de Control NAE-B
- Nano Soldador **NT105-A (x2)**
- Set de Cartuchos (Ref. 0011568):
C105-101, C105-103, C105-107, C105-112
C105-105 (x2), C105-113 (x2)

Utiliza Cartuchos C105



0016079 · Manguitos

8,50 €

Manguitos para las Nano Herramientas

Se suministra en cajas de 4 unidades



A1205 · Cable largo

53,00 €

Para **NP105** y **NT105**



CL2466 · Cepillo metálico

10,00 €

Para **NASE** y **NANE**



Estaciones para Robot

HDRE-2B 230V · Estación HDE para Robot

690,00 €

Composición:

- Unidad de Control HDE-B
- Convertidor **CHB-A**
- Mango HD con cable de 3m **T470-SA**
- No incluye cartucho

Utiliza Cartuchos C470



DDRE-2B 230V · Estación DDE para Robot

690,00 €

Composición:

- Unidad de Control DDE-B
- Convertidor **CHB-A**
- Mango HD con cable de 3m **T470-SA**
- No incluye cartucho

Utiliza Cartuchos C245



CHB-A · Convertidor

60,00 €

Para la Unidades de Control Excellence **DDE** y **HDE**
Para la Unidades de Control Advanced **DI**, **DD** y **DM**



Aportación Automática de Estaño

AL-2A 230V · Estación Soldadora con Aportación Automática de Estaño

1.220,00 €

Composición:

- Unidad de Control AL-A
- Soporte **AL-SD**
- Soldador con aportación automática de estaño **AL250-B**
- Cartucho **C250-403**
- Limpiador de Puntas **ESD CL6166**
- Conjunto de tubos y guías para hilo de \varnothing 0,9 - 1mm - **0002401**

Utiliza Cartuchos C250



AL-IA · Brazo Soporte

420,00 €

Para Soldador **AL250-B**.
Permite tener las manos libres.



Es necesario el uso del Pedal **P-005**.

Alimentador de estaño

SF-210VA 230V · Alimentador de estaño Automático

725,00 €

Composición:

- Unidad de Control SF-A
- Mango con aportación automática de estaño **SF280-A**
- Conjunto guía de \varnothing 1mm **GSF10V**
- Conjunto de accesorios

El soporte SF-SD y la Bobina de estaño no estan incluidas



SF-SD · Soporte para SF280-A

72,00 €



SF280-A · Mango con aportación de estaño

120,00 €



GSF08V · Conjunto guía \varnothing 0,8 mm

90,00 €



GSF10V · Conjunto guía \varnothing 1 mm

90,00 €

GSF15V · Conjunto guía \varnothing 1,5 mm

90,00 €

Premium line

Estaciones de Aire Caliente

TESE-2A 230V · Estación de Aire Caliente de Precisión

1.610,00 €

Composición:

- Unidad de Control TESE-A
- Soporte **TE-SD**
- Conjunto Calefactor 300W **TE-TB**
- Termopar tipo K **PH218**
- Conjunto de accesorios
- *Pupitre con 3 extractores, 5 protectores y 2 trípodes
(*ver composición del pupitre en página 15)



Utiliza boquillas TN

TESE-2QA 230V · Estación de Aire Caliente de Precisión sin pupitre

1.320,00 €

Composición:

- Unidad de Control TESE-A
- Soporte **TE-SD**
- Conjunto Calefactor 300W **TE-TB**
- Termopar tipo K **PH218**
- Boquillas **TN9208, TN9209** y **TN9080**



Utiliza boquillas TN

JTSE-2A 230V · Estación de Aire Caliente

1.690,00 €

Composición:

- Unidad de Control JTSE-A
- Soporte **JT-SD**
- Conjunto Calefactor 700W **JT-T2A**
- Termopar tipo K **PH218**
- Conjunto de accesorios
- *Pupitre con 3 extractores, 5 protectores y 2 trípodes
(*ver composición del pupitre en página 15)



Utiliza boquillas JN

JTSE-2QA 230V · Estación de Aire Caliente sin pupitre

1.395,00 €

Composición:

- Unidad de Control JTSE-A
- Soporte **JT-SD**
- Conjunto Calefactor 700W **JT-T2A**
- Termopar tipo K **PH218**
- Boquillas **JN2012, JN2015** y **JN2020**



Utiliza boquillas JN

Accesorios para JTSE y TESE

Protectores

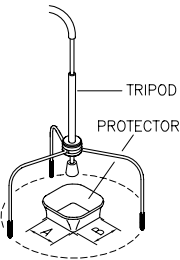
	Ref.	Size (mm)	Price €
 	P3353	4,3 x 3	12,00
	P3786	5,2 x 5,2	12,00
	P3352	5,2 x 7,5	12,00
	P3355	5,2 x 9,5	12,00
	P3356	6,2 x 4,2	12,00
	P3785	7,2 x 7,2	12,00
	P3784	8,2 x 8,2	12,00
	P4035	9 x 13	12,00
	P4040	9,5 x 19	12,00
	P4080	9,5 x 21	12,00
	P2220 *	10 x 10	12,00
	P4045	10,5 x 21	12,00
	P4090	11 x 16	12,00
	P2235 *	12 x 17	12,00
	P1249	12 x 23	12,00

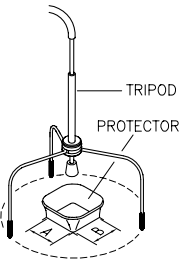
	Ref.	Size (mm)	Price €
 	P4000 *	12,5 x 12,5	12,00
	P1593	13 x 31,5	12,00
	P3354	13,2 x 13,2	12,00
	P4025	13,5 x 21,5	12,00
	P2230 *	15 x 15	12,00
	P4010 *	17 x 17	12,00
	P4005	18 x 29	12,00
	P4030	18,5 x 18,5	12,00
	P1068	18,5 x 24	12,00
	P2685	28,5 x 28,5	12,00
	P4085	31,5 x 31,5	12,00
	P2672	33 x 46	12,00
	P4002	50 x 50	35,00
	P3357	52,5 x 14	44,00

*Suministrados con el Pupitre de la JT y TE

Extractores

	Ref.	Size (mm)	Price €
	E2052 *	20 x 20	33,00
	E2064 *	20 x 26	33,00
	E2184 *	24 x 24	33,00
	E2068	27 x 27	33,00
	E4020	28,5 x 28,5	33,00
	E4015	31,5 x 31,5	33,00
	E2084	33 x 33	33,00
	E2100	38 x 38	33,00
	E2124	45 x 45	33,00

*Suministrados con el Pupitre de la JT y TE

Trípodes

Ref.	Size (mm)	Price €
T2050 *	Ø 39	40,00
T2250 *	Ø 85	40,00

*Suministrados con el Pupitre de la JT y TE



Extractor Manual

Ref.	Size (mm)	Price €
E2190	Ø 7	33,00



Boquillas JT

	Ref.	Size (mm)	Price €
Bent 	JN2015*	Ø 4	16,00
	JN2012*	Ø 6	16,00
	JN6633	Ø 8	16,00
Straight 	JN2020*	Ø 8	14,00
	JN8417*	Ø 10	14,00
Flat 	JN7637	10 x 2	35,00
	JN7638	20 x 2	35,00
	JN7639	30 x 2	35,00

*Suministradas con el Pupitre de la JT

Boquillas TE

	Ref.	Size (mm)	Price €
Bent 	TN9787	Ø 3	15,00
	TN9785	Ø 4	15,00
	TN9782	Ø 5	15,00
Bent 45° 	TN8851	Ø 3	15,00
	TN8905	Ø 4	15,00
	TN9561	Ø 5	15,00
Straight 	TN9209*	Ø 3	9,00
	TN9208*	Ø 4	9,00
	TN9080*	Ø 5	9,00

*Suministradas con el Pupitre de la TE

Premium line

FAE2-5A 230V Aspirahumos

2.040,00 €

Composición:

- FAE2-5A Unidad de control
- FAE2-100 H13 HEPA Carbon filter

Para un sistema de trabajo básico, además es necesario:

- FAE010 - Ø50 Conjunto tubo flexible
- FAE020 / FAE070 - Ø50 Brazo flexible
- FAE030 / FAE040 - Toma de aspiración para soportes
- FAE050 / FAE060 - Tomas de aspiración

Estos ítems no están incluidos



FAE010

Conjunto tubo flexible Ø50

50,00 €

Permite la conexión desde el aspirahumos hasta el brazo flexible.

- Longitud: 1,5 m (extendido)



FAE020

Brazo flexible Ø50

70,00 €

Brazo totalmente flexible para orientarlo a la zona de trabajo.

- Longitud: 0,94 m (comprimido)

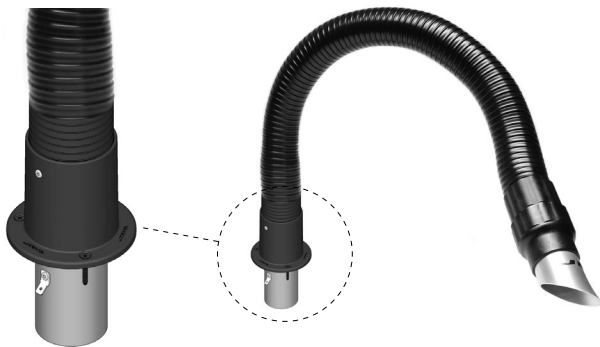

FAE070

Brazo flexible Ø50 + brida

92,00 €

Incorpora una brida para sujetarlo a la mesa.

Totalmente flexible y semirígido para orientarlo a la zona de trabajo.

- Longitud: 0,94 m (comprimido)

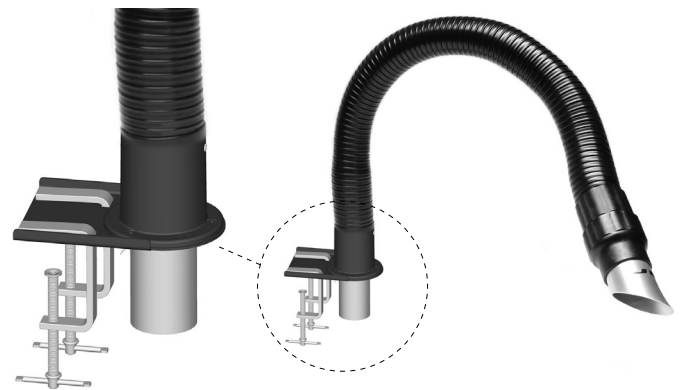

FAE030

Tomas de aspiración soportes

20,00 €

Permite la conexión desde el aspirahumos a los soportes.

Incluye tapones (Ref. 0019101)



FAE040

Tomas de aspiración soportes + brida

42,00 €

Incorpora una brida que permite la sujeción de la toma sin tener que agujerear la mesa.

Incluye tapones (Ref. 0019101)

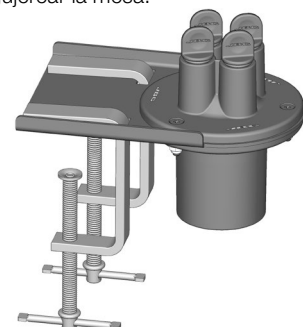

FAE050
Toma aspiración
Soportes gama Modular

30,00 €

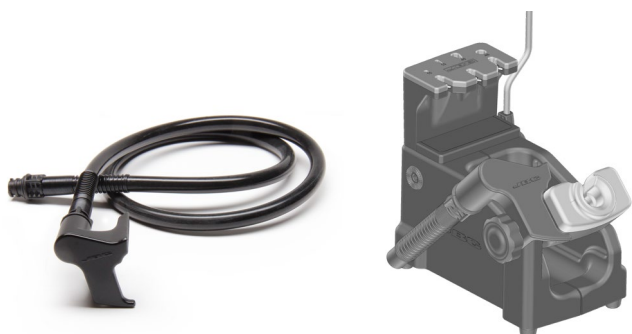

FAE060
Toma aspiración
estaciones Compact

30,00 €



FAE900
Módulo de conexión para
estaciones Advanced

120,00 €

Para unidades de Control DI, DD y DM



FAE800
Módulo de conexión para
estaciones Compact

120,00 €

Para estaciones CD, CA, CP & CSV



0019101
Recambio tapón para
soporte FAE030

5,00 €

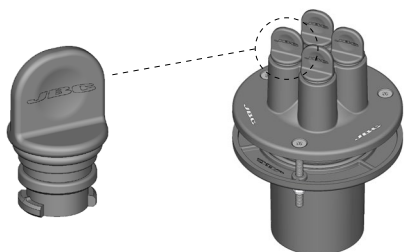

FAE2-100
Filtro compacto

250,00 €

FAE2-110
Pre-Filtro

90,00 €

Se suministra en cajas de 5 unidades

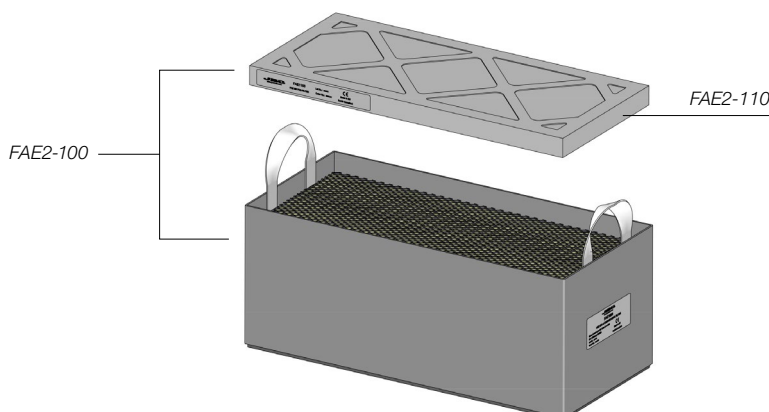

Premium line

Sistema Pre calentador IR

PHS-2KB 230V · Conjunto Pre calentador por Infrarojos

1.260,00 €

Sistema completo para precalentar PCBs multicapa

Composición:

- Unidad Calefactora PH-B
- Consola PH para el control del proceso
- Soporte PHS-SA
- Termopar tipo K PH218
- Cinta Kapton PH217

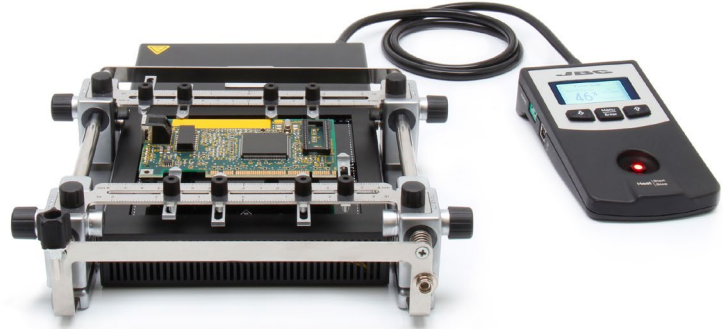

PHS-2B 230V · Pre calentador por Infrarojos

1.050,00 €

Composición:

- Unidad Calefactora PH-B
- Consola PH para el control del proceso
- Termopar tipo K PH218
- Cinta Kapton PH217



PHS-SA · Soporte para PHS

300,00 €

- Dimensiones: 267 x 259 x 75 mm
- Máxima altura: 95 mm

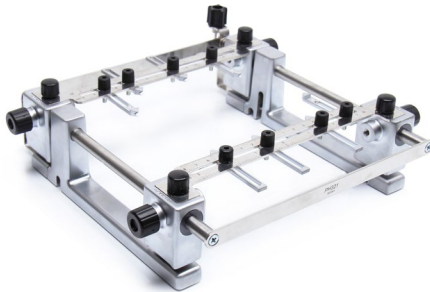

PH218 · Termopar tipo K

48,00 €



PH217 · Cinta Kapton

27,00 €



PH222 · Cinta térmicamente conductora

175,00 €

- Dimensiones: 50 mm



PH223 · Cinta térmicamente conductora

100,00 €

- Dimensiones: 25 mm



Sistema Pre calentador por Convección

PHB-2KA 230V · Conjunto Pre calentador por Convección

2.800,00 €

Sistema completo para precalentar PCBs multicapa

Composición:

- Unidad Calefactora PHB-A
- Consola PH para el control del proceso
- Soporte **PHB-SA**
- Termopar tipo K **PH218**
- Cinta Kapton **PH217**

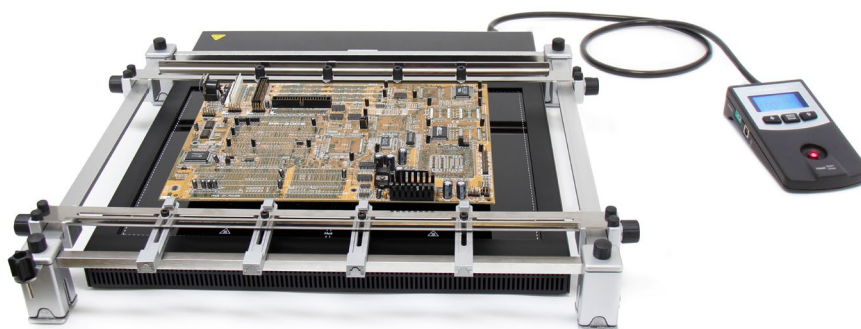

PHB-2A 230V · Pre calentador por Convección

2.250,00 €

Composición:

- Unidad Calefactora PHB-A
- Consola PH para el control del proceso
- Termopar tipo K **PH218**
- Cinta Kapton **PH217**



PHB-SA · Soporte para PHB

590,00 €

- Dimensiones: 432 x 514 x 78 mm
- Máxima altura: 98 mm

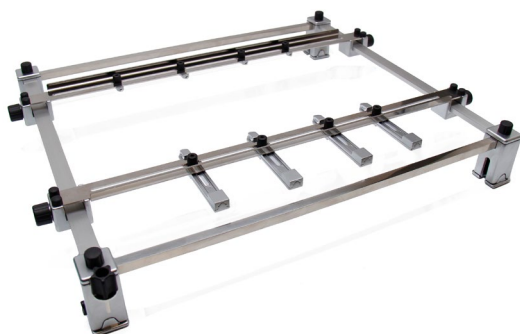

RWB-A · Brazo para Rework para PHB

610,00 €

Dimensiones: 386 x 480 x 550 mm



RWS-A · Brazo para Rework para PHS

550,00 €

Dimensiones: 386 x 270 x 400 mm

RWT-A · Brazo para Rework

490,00 €

Brazo sin base para instalar en el banco de trabajo.
Dimensiones: 386 x 444 x 85 mm

Modular line

Unidades de Control y Módulos

DI-2D 230V · 1 Herramienta

395,00 €



MS-A · Módulo Desoldador Eléctrico

350,00 €

Para estaciones desoldadoras **Compact CS/CS** y Unidades de Control **DI, DD y DM**



MV-A · Módulo Desoldador Neumático

350,00 €

Para estaciones desoldadoras **Compact CS/CS** y Unidades de Control **DI, DD y DM**



FS500-2A 230V · Interruptor para Extractor de Humos

345,00 €

Para Unidades de Control **DI, DD y DM**



GN-A* · Generador de Nitrógeno

1.760,00 €

Alimentado con aire a presión



MN-A · Regulador de Nitrógeno

465,00 €

Para Unidades de Control **DI, DD y DM**



KN-A · Kit de Nitrógeno

665,00 €

Para conectar a la Unidad de Control **DI, DD y DM**

Composición:

- Regulador de caudal de Nitrógeno **MN-A**
- Soporte **DN-SE**
- Mango para Soldador de Nitrógeno **T245-NA**
- Cartucho **C245-903**
- Boquillas **B7243** y **B7244**
- Limpiador de Puntas **ESD CL6166**

Utiliza Cartuchos C245

Es necesario un Generador de Nitrógeno externo o usar el **GN-A*** de JBC

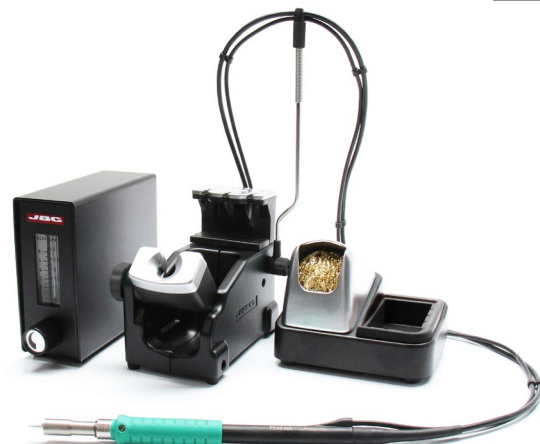

Unidades de Control y Módulos

DDE-2B 230V · 2 Herramientas

520,00 €



DME-2A 230V · 4 Herramientas

790,00 €



MSE-A · Módulo Desoldador Eléctrico

385,00 €

Para Unidades de Control
DDE y **DME**



MVE-A · Módulo Desoldador Neumático

385,00 €

Para Unidades de Control
DDE y **DME**



FSE-2A 230V · Interruptor para
Extractor de Humos

345,00 €

Para Unidades de Control
DDE y **DME**



MNE-A · Regulador de Nitrógeno

465,00 €

Para Unidades de Control
DDE y **DME**



KNE-A · Kit de Nitrógeno

710,00 €

Para conectar a la Unidad de Control **DDE** y **DME**

Composición:

- Regulador de caudal de Nitrógeno **MNE-A**
- Soporte **DN-SE**
- Mango para Soldador de Nitrógeno **T245-NA**
- Cartucho **C245-903**
- Boquillas **B7243** y **B7244**
- Limpiador de Puntas **ESD CL6166**

Utiliza Cartuchos C245

Es necesario un Generador de Nitrógeno externo
o usar el **GN-A*** de JBC



Modular line

Soportes

Para Mangos

AD-SD

Para los Mangos **T245** y **T210**

Incorpora Soporte **S3-B** para 3 cartuchos



136,00 €

DN-SE

Para los Soldadores de Nitrógeno **T210-NA**, **T245-NA** y **T470-NA**



136,00 €

Para Pinzas

PA-SD

Para la Micro Pinza **PA120**



136,00 €

HT-SD

Para la Pinza **HT420**

Incorpora un sistema de soporte para cartuchos de gran tamaño



136,00 €

Para Soldadores con Aportación de Estaño

AP-SD

Para el Soldador con Aportación de Estaño **AP250**



136,00 €

AL-SD

Para el Soldador con Aportación Automática de Estaño **AL250**



136,00 €

Para Desoldadores

DS-SD

Para el Micro Desoldador **DS360**



136,00 €

DR-SD

Para el Desoldador **DR560**

Incorpora un sistema de soporte para puntas



136,00 €

Para herramientas HD

HD-SD

Para los Soldadores HD T470

Incorpora extractor de cartuchos



136,00 €

HDT-SD

Para la Pinza HT470



190,00 €

Para estaciones de Aire Caliente

JT-SD

Para el Calefactor JT-TA

Incorpora extractor de boquillas



136,00 €

TE-SD

Para el Calefactor TE-TB

Incorpora extractor de boquillas



136,00 €

Para cartuchos Crisol

CT-SA

Soporte para cartuchos crisol



190,00 €

Accesorios para soportes

SC-B

Soporte para 12 cartuchos



157,00 €

DC-A

Estuche dispensador de cartuchos C105 y C210

Se suministra vacío



7,00 €

S3-B

Soporte de 3 cartuchos para AD-SD y DN-SD



26,50 €

A1286

Kit alargo de 1,5 m para soportes



49,00 €

CC3702

Accesorio Recogecable

13,00 €



BE-SA

Soporte para Bobina de Estaño

Se suministra vacío

302,00 €



Modular line

Mangos Soldadores y Pinzas

Utiliza gama de cartuchos C105

NP105-B

145,00 €

Nano Pinza Estable

- Sólo funciona con las estaciones NASE y NANE



NP105-A

133,00 €

Nano Pinza

- Sólo funciona con las estaciones NASE y NANE
- Suministrado con N1738



NT105-A

64,00 €

Nano Soldador

- Sólo funciona con las estaciones NASE y NANE



Utiliza gama de cartuchos C210

T210-A

56,00 €

Mango para aplicaciones de precisión



T210-PA

56,00 €

Mango azul de precisión

- Para diferenciarlo rápidamente de otros mangos soldadores



T210-NA

130,00 €

Mango de precisión con aporte de Nitrógeno

- Incluye la boquilla B6647 (Ø 5,3 mm)
- Se necesita el Kit de Nitrógeno KN-A



Utiliza gama de cartuchos C245

T245-A

56,00 €

Mango para aplicaciones generales



T245-C

56,00 €

Mango suave con aislamiento térmico



T245-B

56,00 €

Mango anti-deslizante



T245-PA

56,00 €

Mango azul

- Para diferenciarlo rápidamente de otros mangos soldadores



T245-NA

130,00 €

Mango con aporte de Nitrógeno

- Incluye Boquillas B7243 (Ø 5,7 mm) y B7244 (Ø 7,8 mm)
- Se necesita el Kit de Nitrógeno KN-A



Utiliza gama de cartuchos C245 y C470

Alta potencia

T470-A

Mango HD

84.00 €



T470-SA

Mango HD con cable de 3m

90.00 €



T470-FA

Mango HD con aislamiento térmico

82.00 €



T470-MC

Mango HD con aislamiento térmico y con cable de 3m

90.00 €



T470-ZA

Mango HD trilobular

77.00 €



T470-NA

Mango HD con aporte de Nitrógeno

- Incluye Boquillas HD N1, HD N2, HD N3
- Se necesita el Kit de Nitrógeno KN-A

180.00 €



KHT470A · Kit Pinza HT470 + Soporte

Se necesitan 2 estaciones HDE para su funcionamiento

370.00 €



HT470-A

Pinza HD

- Sólo funciona con 2 Unidades de control HDE

190.00 €



Utiliza gama de cartuchos C120

PA120-A

Micro Pinza

119.00 €



Utiliza gama de cartuchos C420

HT420-A

Pinza para usos generales

108.00 €



Modular line

Desoldadores

Utiliza gama de puntas C360

DS360-A

398,00 €

Micro Desoldador

- Para trabajos de precisión
- Se suministra con punta C360-004



Utiliza gama de puntas C560

DR560-A

365,00 €

Desoldador

- Para usos generales
- Se suministra con punta C560-003



Soldadores con aportación de estaño

Utiliza gama de cartuchos C250

AP250-A

150,00 €

Soldador con Aportación de Estaño

- Se suministra con cartucho C250-403
- Bobina de Estaño con estaño SN5450



AL250-B

188,00 €

Soldador con Aportación automática de Estaño

- Sólo funciona con la Unidad de control AL
- Se suministra con el cartucho C250-403

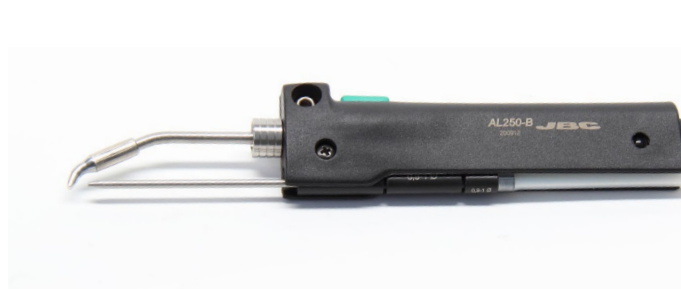

Herramientas para Estaciones de Aire Caliente

Utiliza gama de boquillas TE

TE-TB

265,00 €

Conjunto Calefactor TE para estación de Aire Caliente de Precisión



Utiliza gama de boquillas JT

JT-T2A

240,00 €

Conjunto Calefactor JT para estación de Aire Caliente



Accesorios para Herramientas

Elementos Calefactores

DSV-DS

Para el Micro Desoldador **DS360**

108,00 €



DSV-DR

Para el Desoldador **DR560**

106,00 €

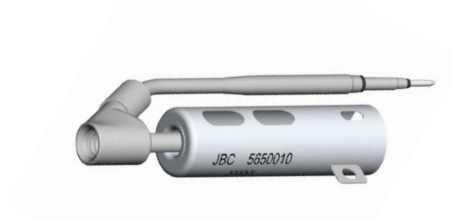

Aspira-humos

F3450

Para Mangos de precisión **T210**
· Diámetro: Ø 4 mm

35,00 €



F3449

Para Mangos **T245**
· Diámetro: Ø 4 mm

40,00 €



F3435

Para Mangos **T245**
· Diámetro: Ø 6 mm

40,00 €



F6457

Para Mangos HD **T470**
· Diámetro: Ø 6 mm

53,00 €



F1204

Para Soldador con
Aportación de
Estaño **AP250**
· Diámetro: Ø 6 mm

23,00 €



F4468

Para Soldador con Aportación automática
de Estaño **AL250**
· Diámetro: Ø 6 mm

53,00 €



Bobinas

SN5450

Hilo de Estaño **"Lead Free"**

· Composición: 99% Sn / 0,3% Ag / 0,7% Cu
· Diámetro: 1 mm Ø
· Peso: 50 grs

7,70 €

Se suministra en cajas de 10 unidades
Precio por unidad



Alargos

A1287

Kit alargó tubo de 1,5 m
para desoldadores

10,40 €



Modular line

Sistemas de limpieza

CLMS-B · Limpiador de puntas Júnior

250,00 €

Composición:

- Cepillos CLMS-A8

CLMS-A8 · Cepillos para CLMS-B

80,00 €



CLMB-A · Limpiador de puntas Sénior

330,00 €

Composición:

- Cepillos metálicos CLMB-A8

CLMB-PA · Limpiador de puntas Sénior

345,00 €

Composición:

- Cepillos no metálicos CLMB-P1



CLMB-A8 · Cepillos metálicos para CLMB-A

80,00 €

Se suministra en cajas de 2 unidades.



CLMB-P1 · Cepillos no metálicos para CLMB-PA

95,00 €

Se suministra en cajas de 2 unidades.



CLMB-A7 · Cepillos metálicos para CLMB-A

80,00 €

Se suministra en cajas de 2 unidades.



CLMB-P7 · Cepillos no metálicos para CLMB-PA

95,00 €

Se suministra en cajas de 2 unidades.



CL6166 · Limpiador de puntas ESD

50,00 €

Composición:

- Esponja S0354
- Lana Latón CL6210
- Tip Wiper ESD CL0240



CL6205 · Lana Inoxidable

3,50 €



CL6210 · Lana Latón

3,50 €



CL0240 · Tip Wiper ESD

10,00 €



S6169 · Esponja

1,60 €

Dimensiones: 58 x 58 mm



S7751 · Esponja

1,70 €

Dimensiones: 46 x 37 mm



S0354 · Esponja

1,70 €

Dimensiones: 36 x 69 mm



CL6220 · Cepillo metálico

27,50 €



CL6217 · Cepillo metálico

15,00 €

Se suministra en cajas de 4 unidades.



TT-A · Re-estañador de puntas

12,00 €

Precio por unidad.
Se suministra en cajas de 5 unidades.



Accesorios

Termómetros

TIA-A · Termómetro

310,00 €



STA-A · Sensor

54,00 €

Para Termómetro TIA-A



TID-A · Termómetro Digital

350,00 €



STD-A · Sensor

64,00 €

Para Termómetro Digital TID-A



Flux

FL-A

7,50 €

Pincel aplicador de 5,5 ml



FL-50

51,00 €

Botella de 500 ml



FL-15

3,20 €

Frasco de 15 ml



Pedales

P-005 · Pedal

185,00 €

Para módulos **MSE, MVE, MNE, FSE**
Para Unidades de control **DME, DDE, HDE, NAE** y **JTE**
Para los Preheaters **PHS-B** y **PHB-A**

Para las estaciones **JT-B** y **TE-B** debe utilizar el adaptador



P-305 · Kit de Pedal

212,00 €

Compatible con la Unidades de control **DI, DD, DDE, DM, DME, HD, HDE.**

Cuando se utiliza la Caja de Conexiones el pedal solo aciva el puerto donde está conectado.



P-105 · Pedal

207,00 €







Sólo para las estaciones **NAST** y **NANT**



Pinzas

Características:

- Fabricadas con acero inoxidable, antimagnético y antiácido con acabado satinado.
- Por el diseño de las Puntas se adaptan tanto a los componentes de inserción como a los SMD.

	Precio unitario
<p>8002099 · AA SA Pinza</p> <p>Para uso general</p> <ul style="list-style-type: none"> · Longitud total: 130 mm 	14,50 €
<p>8002107 · OC SA Pinza de puntas muy finas</p> <ul style="list-style-type: none"> · Longitud total: 90 mm 	14,50 €
<p>8002115 · 2A SA Pinza de puntas redondeadas</p> <ul style="list-style-type: none"> · Longitud total: 115 mm 	14,50 €
<p>8002123 · 3C SA Pinza de puntas muy finas</p> <p>Para trabajos de miniatura</p> <ul style="list-style-type: none"> · Longitud total: 110 mm 	14,50 €
<p>8002131 · 5 SA Pinza de puntas extra finas</p> <ul style="list-style-type: none"> · Longitud total: 110 mm 	14,50 €
<p>8002149 · 7 SA Pinza de puntas curvas</p> <ul style="list-style-type: none"> · Longitud total: 120 mm 	14,50 €

Accesorios

Alicates de corte

Características:

- Corte tipo tijera, facilita el corte con una gran suavidad.
- Acero con tratamiento térmico selectivo, que les confiere dureza en los filos de corte y elasticidad en las empuñaduras.
- Empuñadura ergonómica, recubierta de espuma de vinilo, antideslizante.
- Muelle de retorno, de duración ilimitada y gran suavidad.

SHR270*

Alicate de corte lateral Ø 0,8

11,00 €

Para cortar hilos blandos de hasta 0,8 mm Ø

- Longitud total: 130 mm
- Peso: 46 gr



SHR140

Alicate de corte lateral en acero especial Ø 0,8

15,00 €

Para cortar hilos blandos hasta 0,8 mm Ø

- Longitud total: 123 mm
- Peso: 48 gr



SHR240

Alicate de corte en ángulo de 55°

25,00 €

Para cortar hilos blandos hasta 0,8 mm Ø

- Longitud total: 130 mm
- Peso: 48 gr



SHR180

Alicate de alta durabilidad

25,00 €

Especialmente diseñados para cortar cables de fibra óptica

- Longitud total: 145 mm
- Peso: 66 gr



SHR760

Alicate de corte y fijación

28,00 €

Para cortar y fijar hilos blandos up to 20 AWG (0.8mm) .

- Longitud total: 123 mm
- Peso: 48 gr



SHR2175*

Alicate de corte lateral Ø 1,6

21,00 €

Extramadamente durables y versátiles para cortar cables muy blandos en trabajos finos

- Longitud total: 148 mm
- Peso: 83 gr



*Se suministran en cajas de 10 unidades

SHR193

Alicate de corte

Especialmente diseñado para cortar cables de musica y otro tipo de cables más duros.

Puede cortar cables de musica de hasta Ø1,6 mm

- Longitud total: 140 mm
- Peso: 89 gr

30,00 €



Alicates de Sujeción

PLR540

Alicate de sujeción de punta plana muy fina

Alicates ultra-precisos capaces de sujetar y sostener alambres de menos de Ø 1 mm de espesor.

- Longitud total: 127 mm
- Peso: 50 gr

31,00 €



PLR740

Alicate de sujeción de punta plana

Su perfil extra delgado permitir acceder a áreas de difícil acceso.

- Longitud total: 129 mm
- Peso: 47 gr

16,00 €



PLR195

Alicate extractor de cartuchos

Alicate ideal para la extracción de cartuchos C120 y C420 para las pinzas PA120 y HT420

- Longitud total: 140 mm
- Peso: 48 gr

29,00 €



8002925

Clip retenedor

- Se adapta a los modelos 270 y 140
- Para retener el hilo cortado

2,30 €



Lápices Soldadores **Classic**

2020200 · SL2020 230V · Soldador Termo regulado

84,00

€

Composición:

- Suministrado con punta **R-10D**
- Peso soldador sin cable: 70 gr



Puntas adaptables para el Soldador Termo regulado **SL2020**

Ref.	Size		Unit Price €
0300707 PH-12D	Ø 1,2 mm		11.50
0390401 R-05D	Ø 1 mm		10.50
0300905 R-10D	Ø 1,5 mm		9.50
0300400 B-15D	Ø 2,2 mm		
0400200 B-16D	Ø 2,3 mm		11.00
0300806 TL-3D	Ø 3 mm		
0400804 T-05D	1,5 x 1 mm		
0400705 T-10D	2 x 1 mm		9.50
0300509 T-20D	3 x 1,5 mm		
0300608 T-40D	4,5 x 1,5 mm		9.50

Se suministran en cajas de 10 unidades

0201070 · SG1070 · Soldador de Gas

58,00 €



Composición:

- Suministrado con punt **SF 2.4**
- Peso del soldador sin carga: 150 gr

Autonomía de 2 horas a potencia media



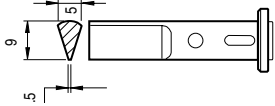
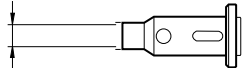
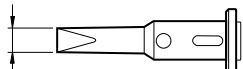
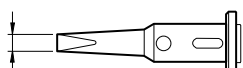
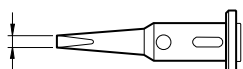
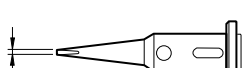

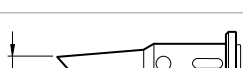
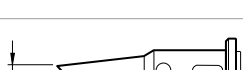







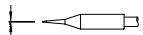





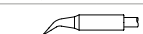

Puntas adaptables para el Soldador de Gas **SG1070**

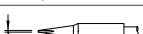
Ref.	Size		Unit Price €
Knife 0201860	A = 9 mm B = 0,5 mm C = 5 mm		10,00
Hot Blow 0201850	Ø 4,5 mm		
DF 4,8 0201840	4,8 x 1,5 mm		
DF 3,2 0201830	3,2 x 1,5 mm		
DF 2,4 0201820	2,4 x 1 mm		
DF 1,0 0201810	1 x 1 mm		
SF 4,8 0201740	Ø 4,8 mm		
SF 3,2 0201730	Ø 3,2 mm		
SF 2,4 0201720	Ø 2,4 mm		
SF 1,0 0201710	Ø 1 mm		

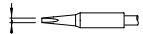
Gama de **Cartuchos**

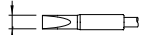

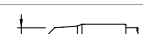
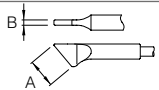
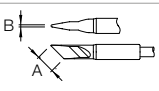
C105 Cartuchos para las Nano Herramientas **NP105** y **NT105**

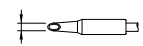
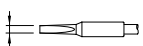
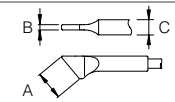
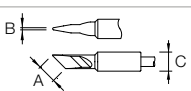
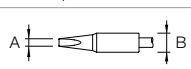
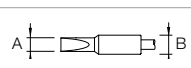
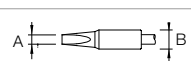
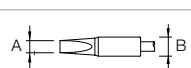
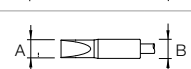
Precio unitario €

	Ref.	Size		1+	10+	50+
	C105-126	Ø 0,1 mm		31.00	28.00	26.00
	C105-101	Ø 0,1 mm				
	C105-103	Ø 0,3 mm				
	C105-106	Ø 0,5 mm				
	C105-107	Ø 0,8 mm				
	C105-124	Ø 0,1 mm		31.00	28.00	26.00
	C105-118	Ø 0,1 mm				
	C105-105	Ø 0,3 mm				
	C105-110	Ø 0,5 mm				
	C105-116	0,2 x 0,1 mm		31.00	28.00	26.00
	C105-117	0,4 x 0,2 mm				
	C105-108	0,6 x 0,3 mm				
	C105-125	1 x 0,2 mm				
	C105-113	1 x 0,3 mm				
	C105-114	1,8 x 0,5 mm				
	C105-109	Ø 0,6 mm		31.00	28.00	26.00
	C105-127	Ø 1 mm				
	C105-111	A = 3,5 mm B = 0,7 mm		31.00	28.00	26.00
	C105-112	A = 2,5 mm B = 0,3 mm				
	C105-120	1 mm				
	C105-128	1 mm		31.00	28.00	26.00
	C105-115	1 mm		39.00	36.00	33.00
	C105-211	A = 3,5 mm B = 0,7 mm C = Ø 2,5 mm		32.00	29.00	27.00
	C105-212	A = 2,5 mm B = 0,3 mm C = Ø 2,5 mm				
	C105-213	A = 1 x 0,3 mm B = Ø 2,5 mm				
	C105-214	A = 1,8 x 0,5 mm B = Ø 2,5 mm				
	C105-221	A = 1,3 x 0,3 mm B = Ø 2,5 mm				
	C105-222	A = 1,6 x 0,3 mm B = Ø 2,5 mm				
	C105-223	A = 2,4 x 0,6 mm B = Ø 2,5 mm				

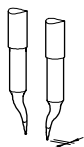
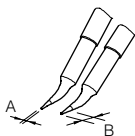
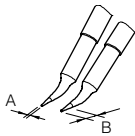
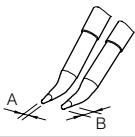
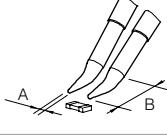

C120 Cartuchos para la Micro Pinza **PA120**

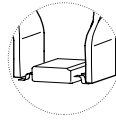
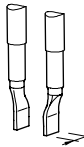
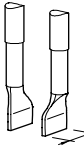
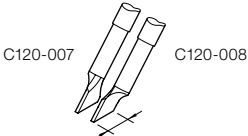
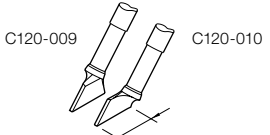
Precio unitario €

	Ref.	Size			1+	10+	50+
	C120-001	Ø 0,2 mm		Chip Components	34.00	29.00	26.00
	C120-002	A = Ø 0,2 mm B = 1,5 mm		Chip Components & Dual in line			
	C120-902	A = Ø 0,3 mm B = 1,5 mm		Chip Components & Dual in line			
	C120-006	A = Ø 0,5 mm B = 1,5 mm		Chip Components & Dual in line			
	C120-004	A = Ø 0,7 mm B = 1,5 mm		Chip Components & Dual in line			
	C120-012	A = Ø 0,7 mm B = 5 mm		Chip Components & Dual in line			
	C120-011	0,6 mm		Chip Components & Dual in line			
	C120-003	3 mm		Chip Components & Dual in line	38.00	32.00	29.00
	C120-005	5 mm		Chip Components & Dual in line			
	C120-007 C120-008	3,5 mm		Chip Components & Dual in line	42.00	35.00	32.00
	C120-009 C120-010	6 mm		Chip Components & Dual in line			



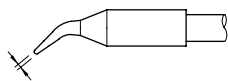
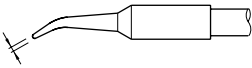
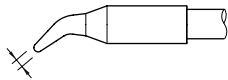
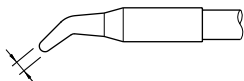
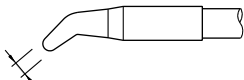
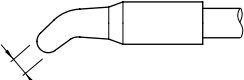
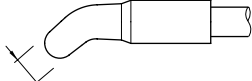

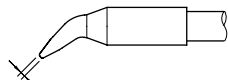
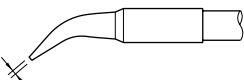
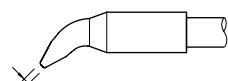
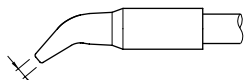
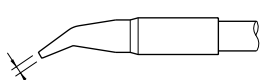











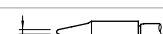

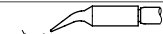
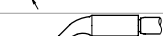
C130 Cartuchos para el Soldador con Aportación de Estaño **AP130**

Precio unitario €

	Ref.	Size		1+	10+	50+
	C130-401	Ø 0,6 mm		31.00	26.00	23.00
	C130-402	Ø 0,8 mm				
	C130-403	Ø 1 mm				
	C130-409	Ø 1,7 mm				
	C130-410	Ø 2,2 mm				
	C130-416	Ø 3 mm				
	C130-417	Ø 4 mm				
	C130-404	1,2 x 0,7 mm		31.00	26.00	23.00
	C130-405	1,8 x 0,8 mm				
	C130-406	2,2 x 1 mm				
	C130-418	3,2 x 1,5 mm				
	C130-419	4,8 x 1,5 mm				

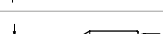
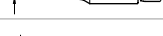
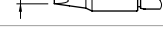



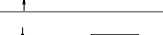
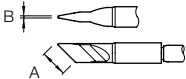
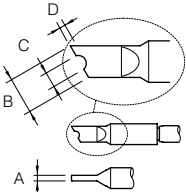
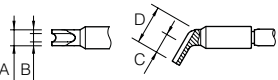
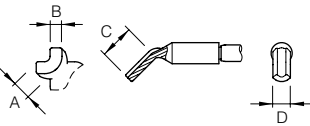
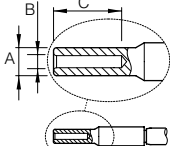





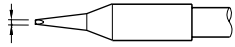
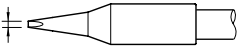

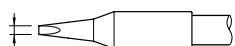
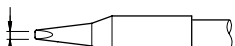

C210 Cartuchos los Mangos de Precisión **T210**

Precio unitario €

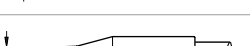
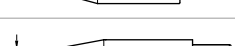
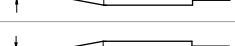
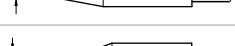
	Ref.	Size		1+	10+	50+
	C210-020	Ø 0,1 mm		33.00	28.00	25.00
	C210-009	Ø 0,2 mm				
	C210-016	Ø 0,3 mm				
	C210-001	Ø 0,3 mm				
	C210-013	Ø 0,5 mm				
	C210-003	Ø 0,6 mm				
	C210-005	Ø 1 mm				
	C210-002	Ø 0,2 mm		33.00	28.00	25.00
	C210-010	Ø 0,3 mm				
	C210-014	Ø 0,5 mm				
	C210-004	Ø 0,7 mm				
	C210-019	0,2 x 0,1 mm		33.00	28.00	25.00
	C210-023	0,4 x 0,2 mm				
	C210-021	0,6 x 0,3 mm				
	C210-024	0,8 x 0,3 mm				
	C210-022	1,3 x 0,4 mm				
	C210-008	1,3 x 0,6 mm				
	C210-007	2,3 x 0,7 mm				
	C210-006	Ø 1 mm		33.00	28.00	25.00
	C210-018	A = 3,4 mm B = 0,3 mm		33.00	28.00	25.00
	C210-012	A = 0,7 mm B = 2,4 mm C = Ø 1 mm D = 0,4 mm		33.00	28.00	25.00
	C210-025	A = 2,1 mm B = 1,1 mm C = 2,5 mm D = 5 mm	 To solder inside a connector	47.00	40.00	36.00
	C210-015	A = 1,2 mm B = 0,8 mm C = 5 mm D = 2,3 mm	 To solder inside a connector	47.00	40.00	36.00
	C210-017	A = Ø 2 mm B = Ø 0,7 mm C = 4,5 mm	 To solder trough hole components on multilayer PCBs	47.00	40.00	36.00

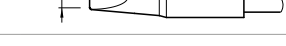
C245 Cartuchos para los Mangos **T245**

Precio unitario €

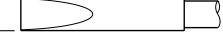
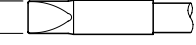









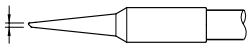

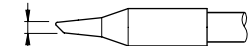



	Ref.	Size			1+	10+	50+
	C245-731	0,6 x 0,3 mm			24,00 30,00*	20,00 25,00*	18,00 23,00*
	C245-773 C245-673*	0,8 x 0,3 mm					
	C245-742	0,8 x 0,6 mm		High Thermal efficiency			
	C245-774	1,2 x 0,3 mm					
	C245-906 C245-806*	1,2 x 0,7 mm					
	C245-406	1,2 x 0,7 mm		High Thermal efficiency			
	C245-768	1,5 x 0,3 mm					
	C245-944 C245-844*	1,8 x 0,8 mm					
	C245-907 C245-807*	2,2 x 1 mm					
	C245-407	2,2 x 1 mm		High Thermal efficiency			
	C245-759	2,4 x 0,5 mm		High Thermal efficiency			
	C245-770	2,4 x 0,3 mm		High Thermal efficiency			
	C245-741	2,4 x 0,6 mm		High Thermal efficiency			
	C245-729	2,7 x 1 mm					
	C245-061 C245-261*	3 x 1 mm					
	C245-911 C245-811*	3,2 x 1,2 mm					
	C245-775	3,2 x 1,2 mm		High Thermal efficiency			
	C245-755	4 x 0,8 mm		High Thermal efficiency			
	C245-756	4,8 x 1 mm		High Thermal efficiency			
	C245-908 C245-808*	4,8 x 1,5 mm		High Thermal efficiency			
C245-708	4,8 x 1,5 mm		High Thermal efficiency				
C245-069	5 x 1,7 mm		High Thermal efficiency				
C245-966 C245-866*	6,6 x 1,8 mm		High Thermal efficiency				

* Estos modelos de Cartucho son 20 mm más largos, facilitando el acceso a lugares difíciles.

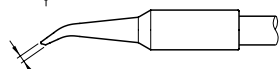
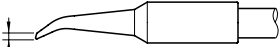
HIGH THERMAL EFFICIENCY: Se caracterizan por su geometría optimizada que permite lograr una mayor eficiencia térmica de entre 20% y 40%.

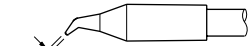
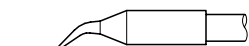
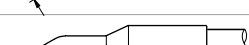
C245 Cartuchos para los Mangos T245

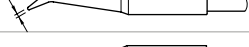
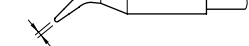
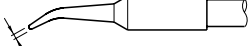
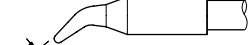
Precio unitario €

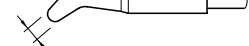







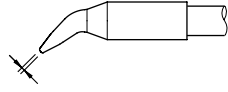
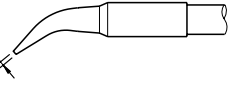
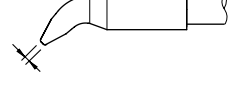

	Ref.	Size		1+	10+	50+
	C245-747	Ø 0,6 mm		24,00 30,00*	20,00 25,00*	18,00 23,00*
	C245-710	Ø 1,2 mm				
	C245-905	Ø 1,5 mm				
	C245-405	Ø 1,5 mm	 High Thermal efficiency			
	C245-945 C245-845*	Ø 2,2 mm				
	C245-784	Ø 2,8 mm				
	C245-912 C245-812*	Ø 3 mm				
	C245-056 C245-256*	Ø 3,5 mm	 High Thermal efficiency			
	C245-951	Ø 3,8 mm	 High Thermal efficiency			
	C245-766	Ø 5 mm	 High Thermal efficiency			
	C245-748	Ø 0,6 mm		37,00	31,00	28,00
	C245-749	Ø 0,6 mm				
	C245-034 C245-234*	Ø 0,4 mm		24,00 30,00*	20,00 25,00*	18,00 23,00*
	C245-029	Ø 0,4 mm				
	C245-126	Ø 0,4 mm				
	C245-786	Ø 0,6 mm				
	C245-929	Ø 0,6 mm				
	C245-935	Ø 0,8 mm				
	C245-904 C245-804*	Ø 1 mm				
	C245-259	Ø 1,5 mm				
	C245-260	Ø 2 mm	 High Thermal efficiency			
	C245-627	Ø 3 mm				
C245-628	Ø 4 mm	 High Thermal efficiency				

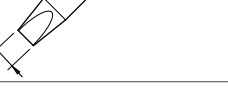
* Estos modelos de Cartucho son 20 mm más largos, facilitando el acceso a lugares difíciles.

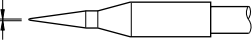
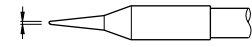
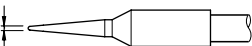
HIGH THERMAL EFFICIENCY: Se caracterizan por su geometría optimizada que permite lograr una mayor eficiencia térmica de entre 20% y 40%.

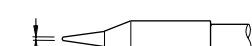
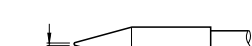
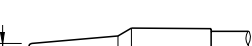
C245 Cartuchos para los Mangos **T245**

Precio unitario €

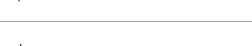
	Ref.	Size		1+	10+	50+
	C245-962 C245-862*	1,2 x 0,7 mm		24,00 30,00*	20,00 25,00*	18,00 23,00*
	C245-963 C245-863*	1,8 x 0,8 mm				
	C245-946 C245-846*	2,2 x 1 mm				
	C245-732	3,2 x 1,5 mm				
	C245-761	3 x 1 mm				
	C245-030	Ø 0,3 mm		24,00 30,00*	20,00 25,00*	18,00 23,00*
	C245-032	Ø 0,4 mm				
	C245-036	Ø 0,5 mm				
	C245-930	Ø 0,5 mm				
	C245-001 C245-201*	Ø 0,6 mm				
	C245-937	Ø 0,6 mm	 High Thermal efficiency			
	C245-957	Ø 0,8 mm				
	C245-903 C245-803*	Ø 1 mm				
	C245-403	Ø 1 mm	 High Thermal efficiency			
	C245-943	Ø 1,7 mm				
	C245-933	Ø 2,2 mm				
	C245-107	Ø 3 mm	 High Thermal efficiency			

* Estos modelos de Cartucho son 20 mm más largos, facilitando el acceso a lugares difíciles.

HIGH THERMAL EFFICIENCY: Se caracterizan por su geometría optimizada que permite lograr una mayor eficiencia térmica de entre 20% y 40%.

C245 Cartuchos para los Mangos T245

Precio unitario €

Ref.	Size			1+	10+	50+
C245-067	Ø 2,3 mm		Mini Spoon	33.00	28.00	25.00
C245-938 C245-931 C245-965	A = Ø 3,8 mm A = Ø 2,7 mm A = Ø 1,9 mm		Mini Spoon			
C245-009	4,5 x 1,8 mm		For drag soldering gullwing leads			
C245-010	4,5 x 1,8 mm		For drag soldering J-lead			
C245-064	Ø 1,3 mm		Hoof tip with reduced tinned surface, ideal for touch up	24.00	20.00	18.00
C245-102	Ø 2 mm		Hoof tip with reduced tinned surface, ideal for touch up			
C245-016 C245-017 C245-018 C245-019	A = 1,9 mm A = 2,2 mm A = 3,4 mm A = 4,5 mm		Chip Components	33.00	28.00	25.00
C245-226 C245-215 C245-304 C245-305 C245-306 C245-222	A = 15,2 B = 29,0 mm A = 9,6 B = 18,0 mm A = 9,6 B = 15,0 mm A = 9,6 B = 12,0 mm A = 9,6 B = 10,0 mm A = 7,1 B = 13,0 mm		Dual in Line	52.00	44.00	40.00
C245-303 C245-221 C245-250 C245-220	A = 6,5 B = 6,0 mm A = 5,4 B = 10,0 mm A = 5,4 B = 8,0 mm A = 5,4 B = 6,0 mm		Dual in Line	50.00	42.00	38.00
C245-227 C245-315 C245-228 C245-224	A = 17,5 B = 17,5 mm A = 15,0 B = 15,0 mm A = 12,4 B = 15,0 mm A = 12,0 B = 12,0 mm			52.00	44.00	40.00
C245-223	A = 8,5 B = 8,5 mm		QFP y PLCC	50.00	42.00	38.00
C245-248 C245-247	N. contact positions = 32 A = 11,9 B = 14,5 mm N. contact positions = 44 A = 17 B = 17 mm			52.00	44.00	40.00
C245-776	A = 37 mm			69.00	58.00	52.00
C245-949	A = 32 mm		Blade Type	50.00	39.00	35.00
C245-913 C245-752 C245-914	A = 21 mm A = 15 mm A = 10 mm			41.00	34.00	31.00
C245-789	A = 3,5 mm B = 0,3 mm		Bevel edge tips	30.00	25.00	23.00

* Estos modelos de Cartucho son 20 mm más largos, facilitando el acceso a lugares difíciles.

HIGH THERMAL EFFICIENCY: Se caracterizan por su geometría optimizada que permite lograr una mayor eficiencia térmica de entre 20% y 40%.



C245 Cartuchos Especiales para los Mangos T245

Precio unitario €

Ref.	Size			1+	10+	50+
C245-955	A = 13 mm B = 0,5 mm		Bevel edge tips	39,00	33,00	29,00
C245-939	A = 6 mm B = 0,4 mm		Bevel edge tips	30,00	25,00	23,00
C245-765	A = 6 mm B = 0,4 mm		Bevel edge tips	30,00	25,00	23,00
C245-053	A = Ø 5 mm B = Ø 3,8 mm		Chrome finish, designed for plastic rivets	33,00	28,00	25,00
C245-052	A = Ø 6 mm B = Ø 4,9 mm		Chrome finish, designed for plastic rivets			
C245-054	A = Ø 7 mm B = Ø 6,5 mm		Chrome finish, designed for plastic rivets			
C245-138	12 mm		Designed for cutting plastics	44,00	37,00	33,00
C245-312	Ø 3,2 mm		Chrome finish, designed for use in plastics	35,00	29,00	26,00
C245-313	Ø 4,1 mm		Chrome finish, designed for use in plastics			
C245-124	A = 4,25 x 2 mm B = 0,7 mm		Chrome finish, designed for use in plastics	36,00	30,00	27,00
C245-123	4 x 4 mm		Chrome finish, designed for use in plastics	38,00	32,00	29,00
C245-121	13 mm		Designed for use in plastics	44,00	37,00	33,00
C245-109	4,3 x 0,1 mm		Designed for use in plastics	30,00	25,00	23,00

C245 Cartuchos Especiales para los Mangos T245

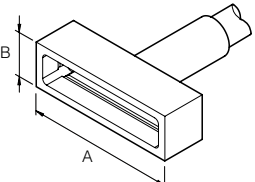
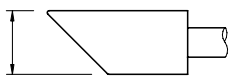
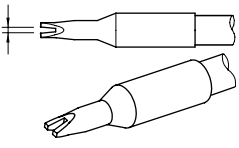
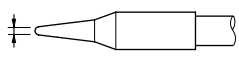
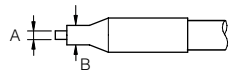
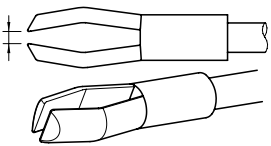

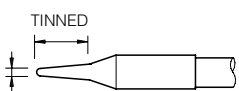
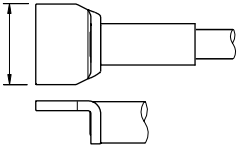
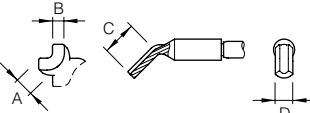
Precio unitario €

Ref.	Size		1+	10+	50+	
C245-311	A = 20 mm B = 6 mm		Chrome finish, designed for use in plastics	45.00	38.00	34.00
C245-301	Ø 8,8 mm		Big contact surface to solder large applications	45.00	38.00	34.00
C245-118	Ø 8,8 mm		Cable tinning	36.00	30.00	27.00
C245-119	Ø 1 mm		PTFE coated tip	53.00	45.00	40.00
C245-117	A = Ø 1,45 mm B = Ø 2,9 mm		For Through hole soldering	35.00	29.00	26.00
C245-268	1,5 mm		Specially pro- duced for fast soldering on male contacts	48.00	41.00	36.00
C245-136	A = 7,1mm B = 6,5 mm		Specially pro- duced for micro stick switch	45.00	38.00	34.00
C245-041	Ø 1 mm		Tip with an extra tinned surface	24.00	20.00	18.00
C245-730	10 mm		Rework blade	47.00	40.00	36.00
C245-116	A = 1,4 mm B = 0,9 mm C = 5 mm D = 3 mm		To solder inside a connector	42.00	35.00	32.00

* Estos modelos de Cartucho son 20 mm más largos, facilitando el acceso a lugares difíciles.

C245 Cartuchos Especiales para los Mangos **T245**

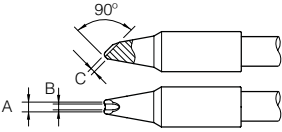
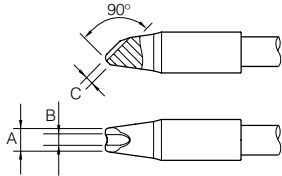
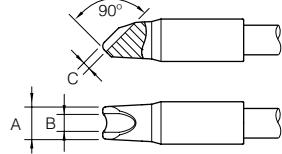
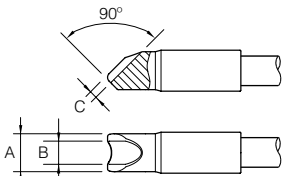
Precio unitario €

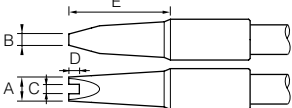
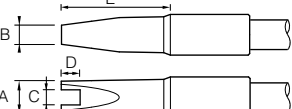
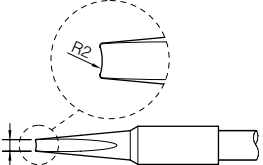
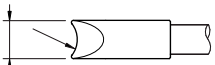
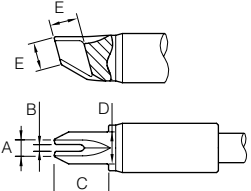
Ref.	Size		1+	10+	50+
C245-790	A = 1,8 mm B = 0,8 mm C = 0,4 mm		29.00	24.00	22.00
C245-785	A = 3 mm B = 1,5 mm C = 0,6 mm		29.00	24.00	22.00
C245-763	A = 4 mm B = 2,5 mm C = 1 mm		29.00	24.00	22.00
C245-760	A = 5 mm B = 3,5 mm C = 1 mm		29.00	24.00	22.00
C245-150	A = 2,2 mm B = 3,5 mm		29.00	24.00	22.00
C245-757	A = 3,2 mm B = 1,5 mm C = 1,25 mm D = 1,4 mm E = 13,5 mm		29.00	24.00	22.00
C245-758	A = 4,3 mm B = 2,5 mm C = 2 mm D = 2,5 mm E = 14,5 mm		29.00	24.00	22.00
C245-122	1,5 X 0,5 mm		36.00	30.00	27.00
C245-762	6,7 X 1,8 mm		34.00	29.00	26.00
C245-754 C245-654*	A = 2 mm B = 0,75 mm C = 6 mm D = 3,5 mm E = 3 mm		32.00 37.00*	27.00 31.00*	24.00 28.00*

Through hole
drag soldering

* Estos modelos de Cartucho son 20 mm más largos, facilitando el acceso a lugares difíciles.

C245 Cartuchos Especiales para los Mangos T245

Precio unitario €

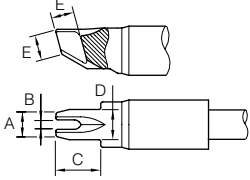
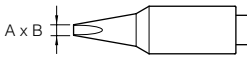
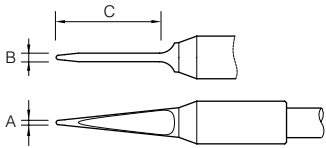
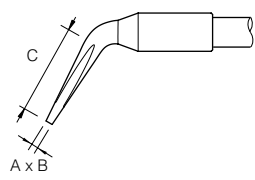
Ref.	Size		1+	10+	50+
C245-751 C245-651*	A = 3,25 mm B = 1,25 mm C = 6 mm D = 4 mm E = 3 mm				
C245-667	A = 3,25 mm B = 1,25 mm C = 12 mm D = 4 mm E = 3 mm		32.00 37.00*	27.00 31.00*	24.00 28.00*
C245-669	A = 3 mm B = 1,25 mm C = 12 mm D = 3,5 mm E = 3 mm F = 5 mm				
C245-772	1,4 x 0,7 mm		53.00	45.00	40.00
C245-764	A = Ø 0,5 mm B = 1 mm C = 12 mm		24.00	20.00	18.00
C245-771	A = 1 mm B = 0,1 mm C = 13 mm		30.00	25.00	23.00



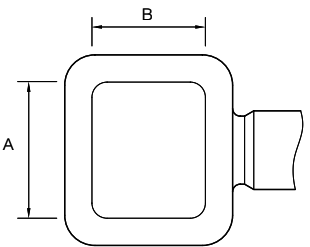







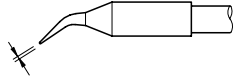
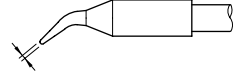
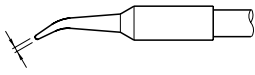
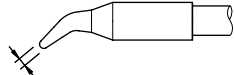

C245 Cartuchos Crisol para los Mangos T245

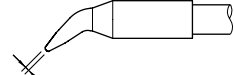
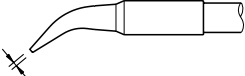
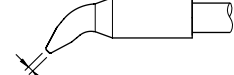
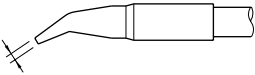
C245-SP01	A = 18 mm B = 15 mm		90.00		
------------------	------------------------	---	-------	--	--

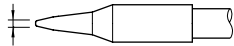
* Estos modelos de Cartucho son 20 mm más largos, facilitando el acceso a lugares difíciles.

C250 Cartuchos para el Soldador con Aportación Automática de Estaño **AL250**

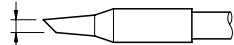
Precio unitario €

	Ref.	Size		1+	10+	50+
	C250-420	Ø 0,4 mm		33.00	28.00	25.00
	C250-401	Ø 0,6 mm				
	C250-402	Ø 0,8 mm				
	C250-403	Ø 1 mm				
	C250-409	Ø 1,7 mm				
	C250-410	Ø 2,2 mm				
	C250-404	1,2 x 0,7 mm		33.00	28.00	25.00
	C250-405	1,8 x 0,8 mm				
	C250-406	2,2 x 1 mm				
	C250-412	4,8 x 1,5 mm				
	C250-418	3,2 x 1,5 mm				
	C250-407	1,2 x 0,7 mm		33.00	28.00	25.00
	C250-408	2,2 x 1 mm				
	C250-413	2,2 x 1 mm				
	C250-411	4,8 x 1,5 mm				
	C250-414	Ø 2,2 mm		33.00	28.00	25.00
	C250-415	Ø 3,8 mm				

C420 Cartuchos para la Pinza HT420

Precio unitario €

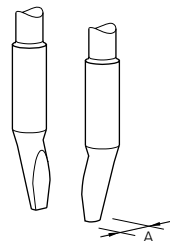
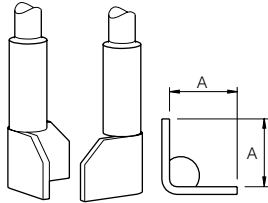
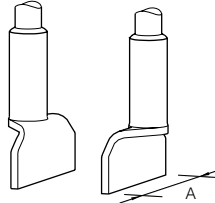
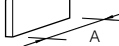
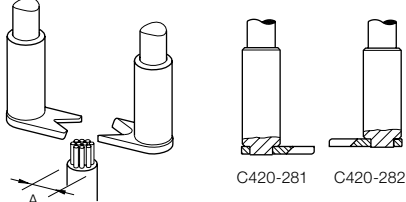
Ref.	Size		1+	10+	50+
C420-271 C420-272	A = 1,5 mm A = 2,6 mm		37.00	31.00	28.00
C420-279 C420-280	A = 8,0 mm A = 11,0 mm		41.00	34.00	31.00
C420-273 C420-274 C420-275 C420-276 C420-277 C420-278	A = 4,0 mm A = 6,0 mm A = 8,0 mm A = 10,0 mm A = 15,0 mm A = 20,0 mm		41.00	34.00	31.00
C420-285	A = 22,0 mm		53.00	45.00	40.00
C420-281 C420-282	Cable stripper A = Ø 3,5 mm máx. A = Ø 3,5 mm máx.		41.00	34.00	31.00

C420 Cartuchos Especiales para la Pinza HT420

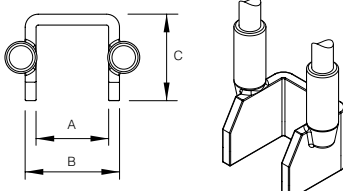
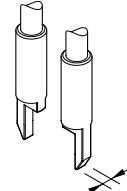
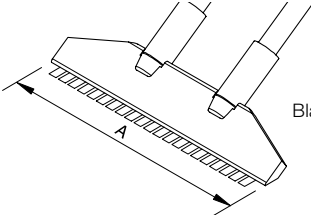
C420-286	A = 12 mm B = 15,6 mm C = 14,3 mm		117.00	98.00	88.00
C420-287	2 mm		76.00	64.00	57.00
C420-283	A = 50 mm		127.00	107.00	96.00

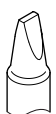
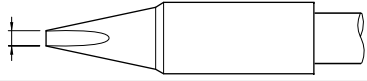
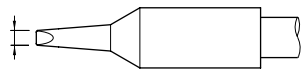
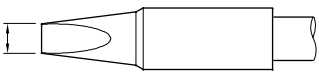
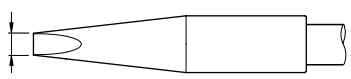
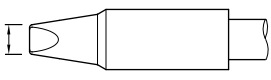
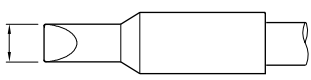
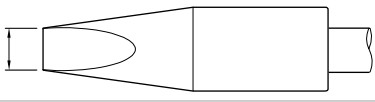
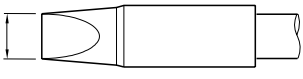
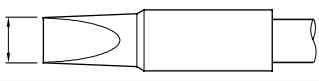
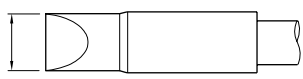
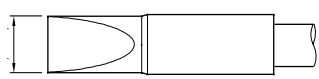
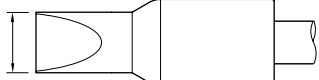
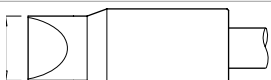
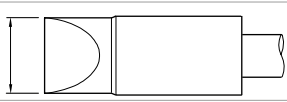
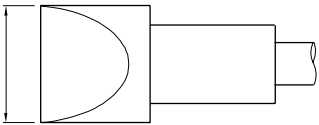
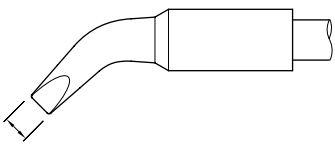
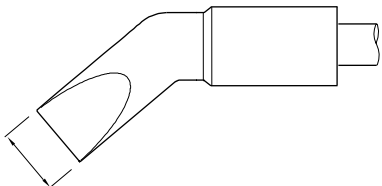

C470 Cartuchos para los Mangos HD **T470** y la Pinza HD **HT470**

Precio unitario €

	Ref.	Size		1+	10+	50+
	C470-013	2 x 0,9 mm		36,00	28,00	25,00
	C470-036	2 x 1 mm				
	C470-014	4 x 1,3 mm				
	C470-040	4 x 1,3 mm		38,00	33,00	30,00
	C470-035	4 x 2,5 mm		36,00	28,00	25,00
	C470-017	5 x 1,2 mm				
	C470-009	5,5 x 1,5 mm				
	C470-002	6 x 1,5 mm				
	C470-015	6 x 1,7 mm				
	C470-004	7,5 x 1,5 mm				
	C470-016	7,5 x 1,7 mm				
	C470-058	8 x 2,5 mm				
	C470-039	8,5 x 2,5 mm				
	C470-006	10 x 2,5 mm				
	C470-007	15,5 x 2,5 mm				
	C470-034	3,5 x 1,5 mm		40,00	32,00	28,00
	C470-018	8,9 x 1,7 mm				

C470 Cartuchos Especiales para los Mangos HD **T470** y la Pinza HD **HT470**

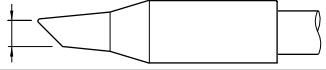
Precio unitario €

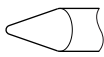
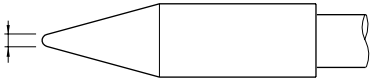
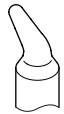
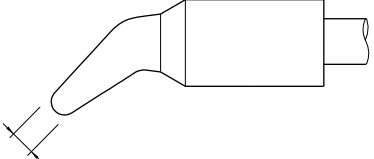
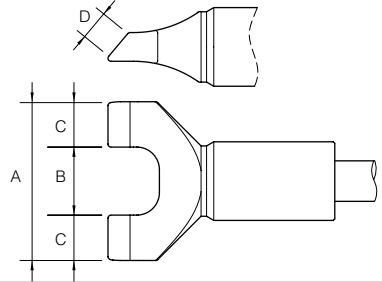
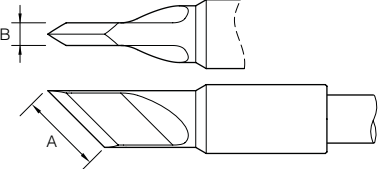
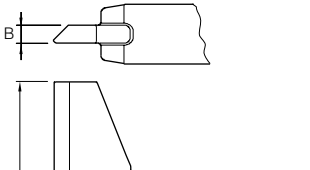
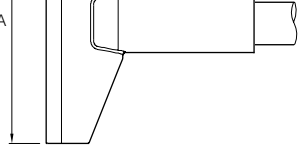
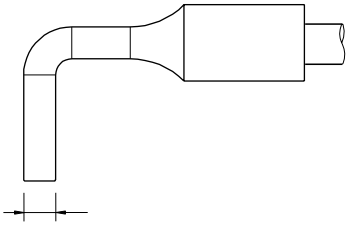
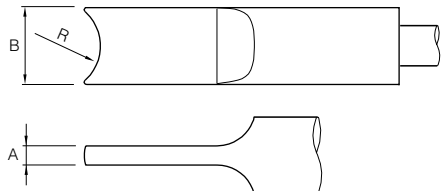
	Ref.	Size		1+	10+	50+
	C470-019	Ø 3,5 mm		36,00	30,00	27,00
	C470-003	Ø 7,5 mm				
	C470-056	Ø 10 mm				
	C470-001	Ø 1,7 mm		36,00	30,00	27,00
	C470-008	Ø 3,5 mm		36,00	30,00	27,00
	C470-051	A = 21 mm B = 9 mm C = 6 mm D = 4 mm		74,00	62,00	56,00
	C470-061	A = 10,6 mm B = 3 mm		55,00	46,00	42,00
	C470-059	A = 20 mm B = 2,4 mm		55,00	46,00	42,00
	C470-023	A = 32,2 mm B = 2,4 mm		85,00	71,00	64,00
	C470-011	Ø 4,2 mm		51,00	43,00	39,00
	C470-012	A = 2,5 mm B = 10,4 mm R = 6 mm		51,00	43,00	39,00

C470 Cartuchos Especiales para los Mangos HD **T470** y la Pinza HD **HT470**

Precio unitario €

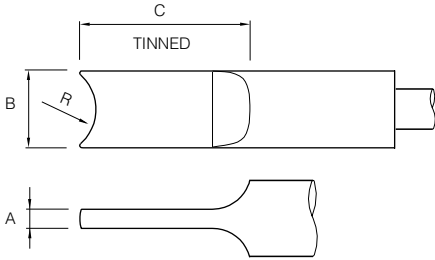
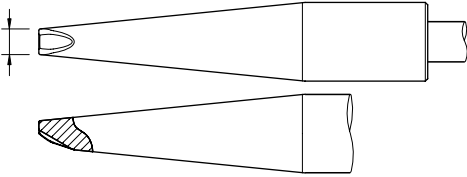
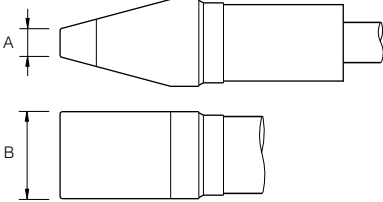
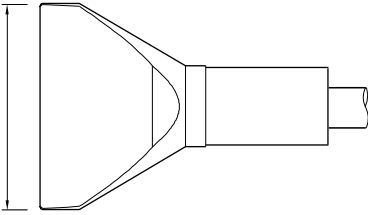
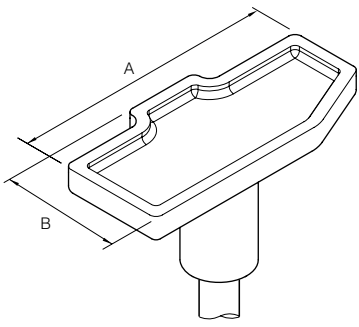
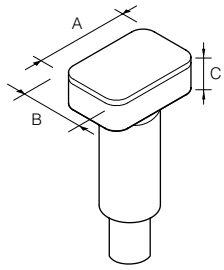
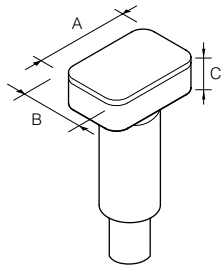
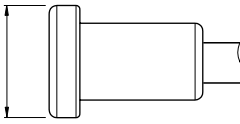
Ref.	Size	1+	10+	50+
C470-038	<p>A = 2,5 mm B = 10,4 mm C = 22 mm R = 6 mm</p> 	47,00	40,00	36,00
C470-020	<p>Ø 3,4 mm</p> 	74,00	62,00	56,00
C470-021	<p>A = 4 mm B = 12 mm</p> 	74,00	62,00	56,00
C470-022	<p>28 x 4 mm</p> 	102,00	86,00	77,00
C470-027	<p>A = 43 mm B = 20 mm</p> 	275,00	225,00	205,00
C470-044	<p>A = 15 mm B = 10 mm C = 5 mm</p> 	65,00	55,00	49,00
C470-057	<p>A = 30 mm B = 20 mm C = 5 mm</p> 	74,00	62,00	56,00
C470-005	<p>Ø 15 mm</p> 	40,00	34,00	30,00

C470 Cartuchos Especiales para los Mangos HD **T470** y la Pinza HD **HT470**

Precio unitario €

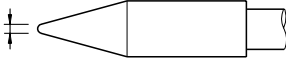
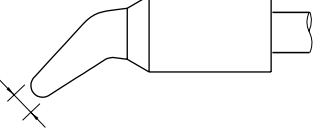
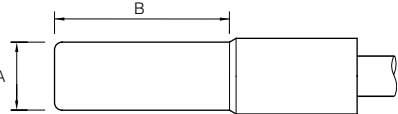
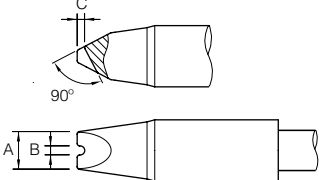
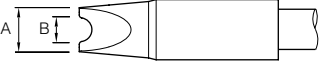
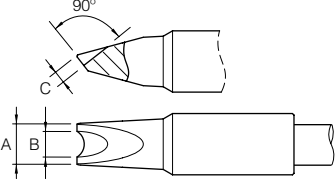
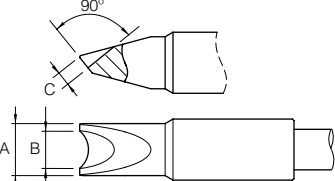
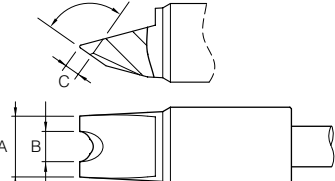
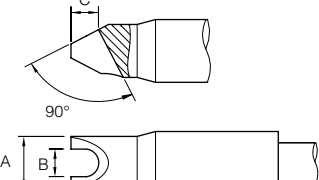
Ref.	Size		1+	10+	50+
C470-025	Ø 1,7 mm		41.00	34.00	31.00
C470-026	Ø 3,5 mm		41.00	34.00	31.00
C470-032	A = Ø 9 mm B = 24 mm		42.00	35.00	32.00
C470-028	A = 5 x 1,8 mm B = 1,2 mm C = 1 mm		52.00	44.00	40.00
C470-031	A = 6 x 1,8 mm B = 3,2 mm		52.00	44.00	40.00
C470-048	A = 5,5 mm B = 3,4 mm C = 1,6 mm		52.00	44.00	40.00
C470-049	A = 6,9 mm B = 5,2 mm C = 1,9 mm		52.00	44.00	40.00
C470-055	A = 8 mm B = Ø 4 mm C = 2 mm		52.00	44.00	40.00
C470-033	A = 7 x 1,8 mm B = 3,65 mm C = 3,6 mm		52.00	44.00	40.00

C470 Cartuchos Especiales para los Mangos HD **T470** y la Pinza HD **HT470**

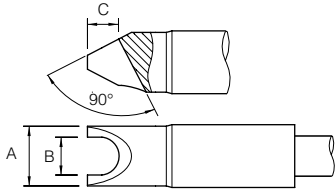
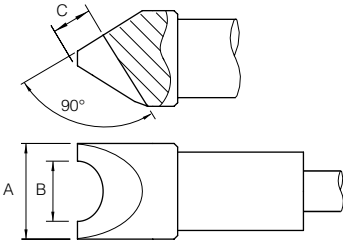
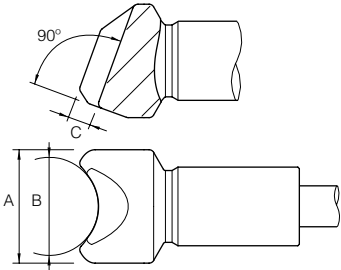
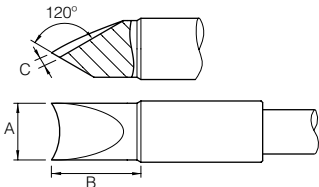
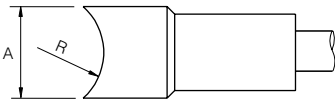
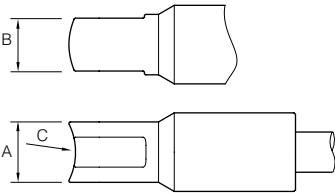
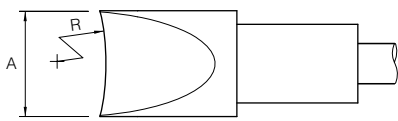
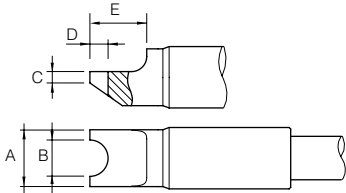
Ref.	Size	1+	10+	50+	
C470-030	A = 7,9 x 1,8 mm B = 5 mm C = 4 mm		40.00	34.00	30.00
C470-037	A = 12,7 x 1,9 mm B = 8 mm C = 5 mm		47.00	39.00	35.00
C470-041	A = Ø 15 mm B = Ø 12,5 mm C = 3 mm		53.00	45.00	40.00
C470-047	A = 7,5 mm B = 12 mm C = 1,1 mm		47.00	39.00	35.00
C470-010	A = Ø 12,2 mm R = 8 mm		56.00	47.00	42.00
C470-052	A = 8 mm B = 7 mm C = 8,5 mm		79.00	66.00	59.00
C470-029	A = 14 x 3 mm R = 31 mm		53.00	45.00	40.00
C470-042	A = 7,5 mm B = 4,8 mm C = 3 mm D = 2,4 mm E = 7,5 mm		45.00	38.00	34.00

C470 Cartuchos Especiales para los Mangos HD **T470** y la Pinza HD **HT470**

Precio unitario €

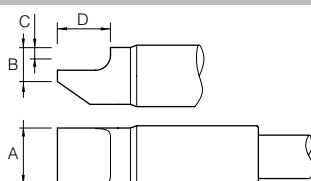
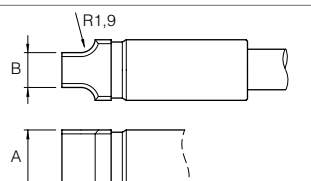
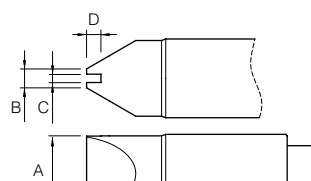
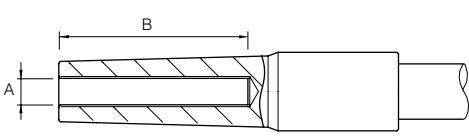

Ref.	Size		1+	10+	50+
C470-046	A = 7,5 mm B = 4,5 mm C = 1,5 mm D = 7 mm		42.00	35.00	32.00
C470-050	A = 8 mm B = 4,6 mm		42.00	35.00	32.00
C470-043	A = 10 mm B = 2,5 mm C = 1,1 mm D = 1,9 mm		40.00	34.00	30.00
C470-045	A = Ø 8 mm B = 25 mm		55.00	46.00	41.00

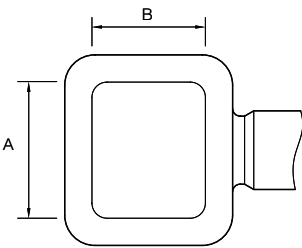
C470 Cartuchos Crisol para los Mangos **T470**

C470-SP01	A = 18 mm B = 15 mm		105.00		
------------------	------------------------	---	--------	--	--

C360 Puntas para el Micro Desoldador **DS360**

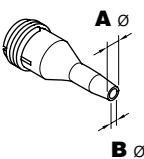
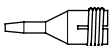
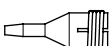
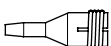
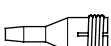
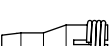

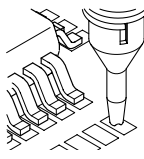
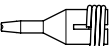
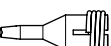
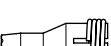
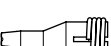



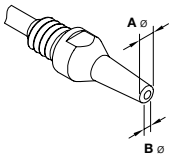
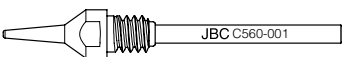
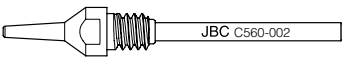

Precio unitario €

	Ref.	Size		1+	10+	50+
	C360-001	A = Ø 1 mm B = Ø 0,6 mm Ø máx. pin = 0,4 mm		8.00	7.00	6.00
	C360-002	A = Ø 1,2 mm B = Ø 0,8 mm Ø máx. pin = 0,6 mm				
	C360-003	A = Ø 1,4 mm B = Ø 1 mm Ø máx. pin = 0,8 mm				
	C360-004	A = Ø 1,6 mm B = Ø 1,2 mm Ø máx. pin = 1 mm				
	C360-007	A = Ø 1,9 mm B = Ø 1,4 mm Ø máx. pin = 1,2 mm				
	C360-006	A = Ø 3 mm B = Ø 1,5 mm Ø máx. pin = 1,3 mm				
<p>PAD CLEANING</p> 	C360-011	A = Ø 1 mm B = Ø 0,6 mm		11.00	10.00	9.00
	C360-012	A = Ø 1,2 mm B = Ø 0,8 mm				
	C360-013	A = Ø 1,4 mm B = Ø 1 mm				
	C360-014	A = Ø 1,6 mm B = Ø 1,2 mm				

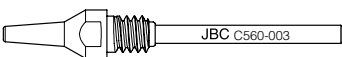
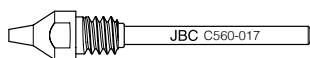
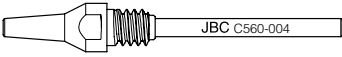
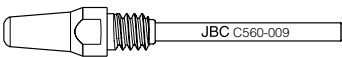
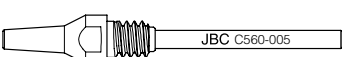
Se suministran en cajas de 10 unidades

C560 Puntas para el Desoldador DR560

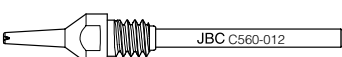
Precio unitario €

	Ref.	Size		1+	10+	50+
	C560-001	A = Ø 1,4 mm B = Ø 0,6 mm Ø máx. pin = 0,4 mm		17.50	14.50	13.00
	C560-002	A = Ø 1,8 mm B = Ø 0,8 mm Ø máx. pin = 0,6 mm				
	C560-014	A = Ø 2,5 mm B = Ø 0,8 mm Ø máx. pin = 0,6 mm		19.60	16.50	14.50
	C560-003	A = Ø 2,7 mm B = Ø 1 mm Ø máx. pin = 0,8 mm				
	C560-017	A = Ø 2 mm B = Ø 1,1 mm Ø máx. pin = 1 mm				
	C560-004	A = Ø 3,2 mm B = Ø 1,3 mm Ø máx. pin = 1,1 mm				
	C560-009	A = Ø 5 mm B = Ø 1,3 mm Ø máx. pin = 1,1 mm				
	C560-005	A = Ø 3,4 mm B = Ø 1,5 mm Ø máx. pin = 1,3 mm				
	C560-006	A = Ø 4,2 mm B = Ø 1,9 mm Ø máx. pin = 1,7 mm				
	C560-007	A = Ø 4,8 mm B = Ø 2,4 mm Ø máx. pin = 2,2 mm				
	C560-015	A = Ø 5,2 mm B = Ø 3 mm Ø máx. pin = 2,8 mm				
		C560-011	A = Ø 1,4 mm B = Ø 0,6 mm			
C560-012		A = Ø 1,8 mm B = Ø 0,8 mm				
C560-013		A = Ø 2,7 mm B = Ø 1 mm				

Condiciones de venta

Los precios de esta tarifa son sin IVA y se entienden para mercancía puesta en nuestros almacenes.

La mercancía viaja por cuenta y riesgo del comprador.

JBC se reserva el derecho de modificar cualquier producto o precio sin previo aviso.

Esta tarifa de precios es válida desde el 1 de Enero de 2017.

