

# EX Series Touch Panel



Manual  
www.ltech-led.com

## System diagram

### L-BUS

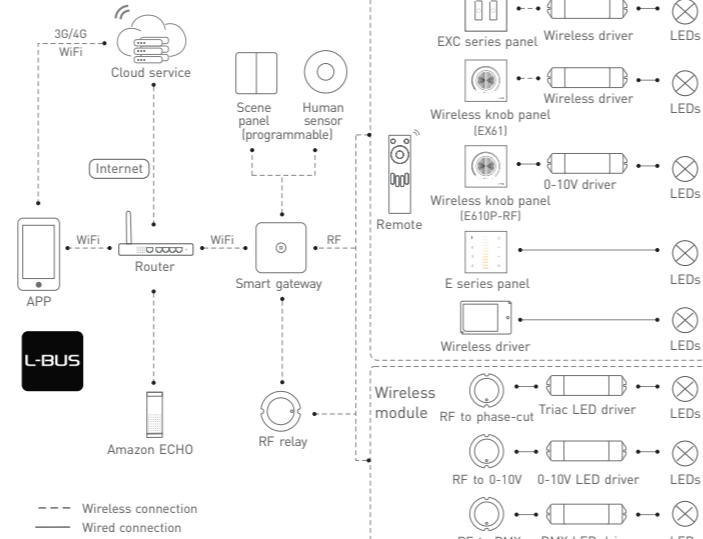

## Product features

- Adopt wireless RF and wired DMX512 protocol 2 in 1 control mode, more flexible and convenient for project installation.
- Advanced RF wireless sync/zone control technology, make sure dynamic color modes synchronously among multiple drivers.
- Install touch panel at different areas, can control the same LED light, achieve multi-panel control, no quantity limited.
- Touch keys with chord and LED indicator.
- Adopts capacitive touch control technology makes LED dimming selection more user-friendly.
- Compatible with remote and APP control.

## Technical specs

Model	EX1	EX1S	EX2	EX3	EX3S	EX4	EX4S
Control type	Dimming		CT	RGB		RGBW	
Input voltage	100-240Vac						
Output signal	RF 2.4GHz, DMX512						
Working temp.	-20°C~55°C						
Dimensions	L86×W86×H36(mm)						
Package size	L113×W112×H50(mm)						
Weight(G.W.)	225g						

\* Product with **L-BUS** Advance Mode logo, supports the function of WIFI-108 advanced mode.



RCM certification No.: RCMPT17114 001

## Installation instruction

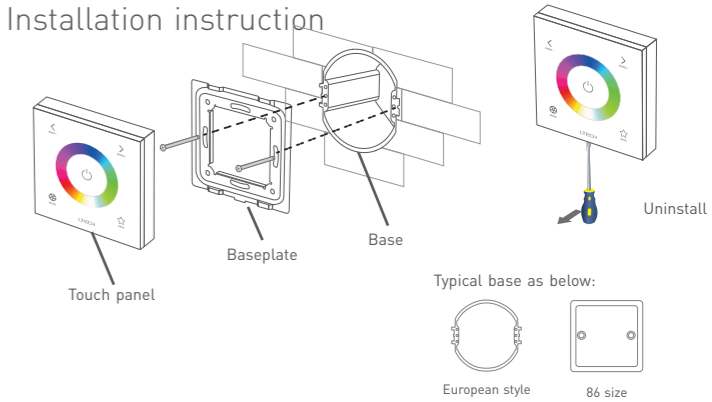

## Product size

Unit: mm

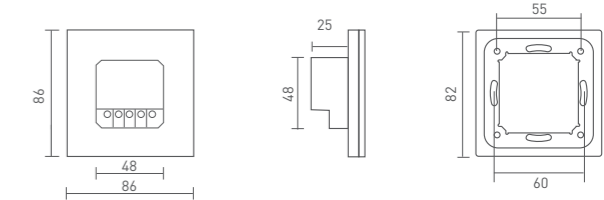

## Terminals

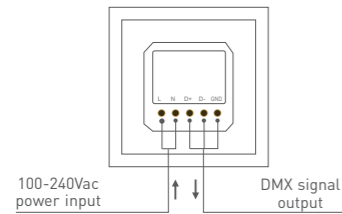

## Key functions

- \* When blue indicator light of key is on, long press to turn on/off buzzer. When white indicator light of key is on, long press to match code.
- \* EX panel's scene-mode keys are corresponding with gateway APP's scenes, the scenes can be changed by APP or panel.

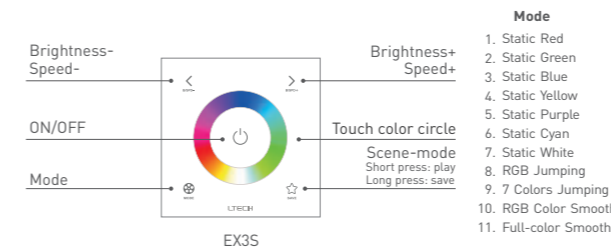
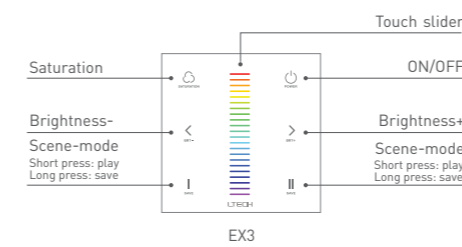
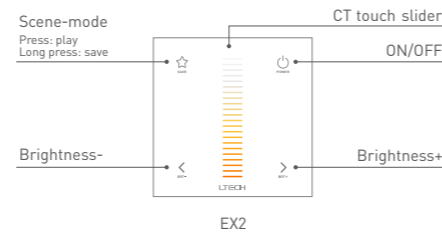
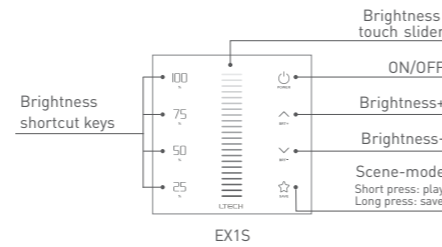
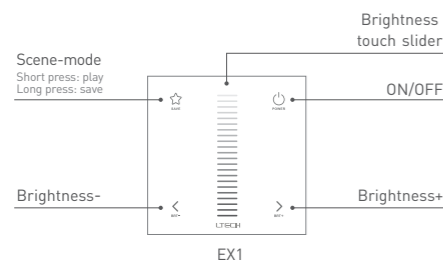

- Mode**
1. Static Red
  2. Static Green
  3. Static Blue
  4. Static Yellow
  5. Static Purple
  6. Static Cyan
  7. Static White
  8. RGB Jumping
  9. 7 Colors Jumping
  10. RGB Color Smooth
  11. Full-color Smooth

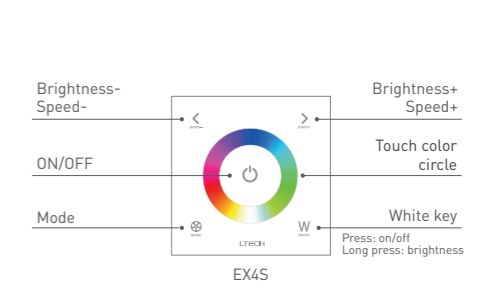
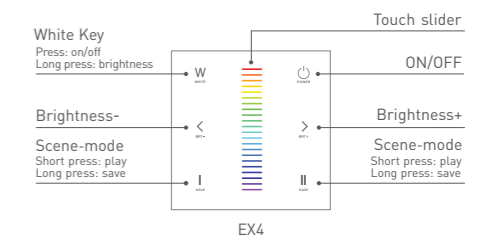

- Mode**
1. Static Red
  2. Static Green
  3. Static Blue
  4. Static Yellow
  5. Static Purple
  6. Static Cyan
  7. Static White
  8. RGB Jumping
  9. 7 Colors Jumping
  10. RGB Color Smooth
  11. Full-color Smooth
  12. Static Black (only close RGB)

\* White light only: press key to choose black mode, then press W key for white light.

### Match code sequence

DMX system wiring

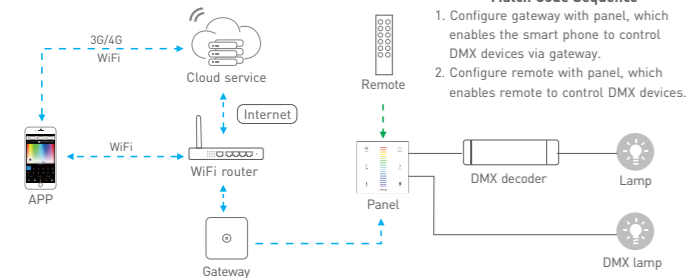

Wireless system wiring

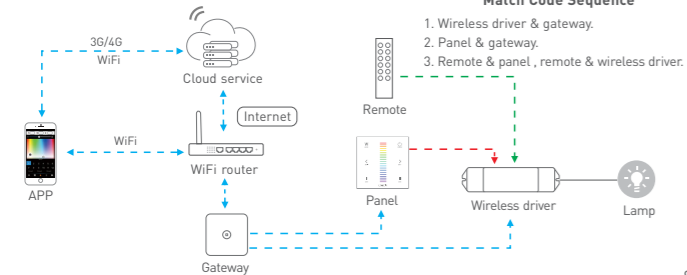

### Application composition

DMX512 control



Wireless control



### DMX wiring

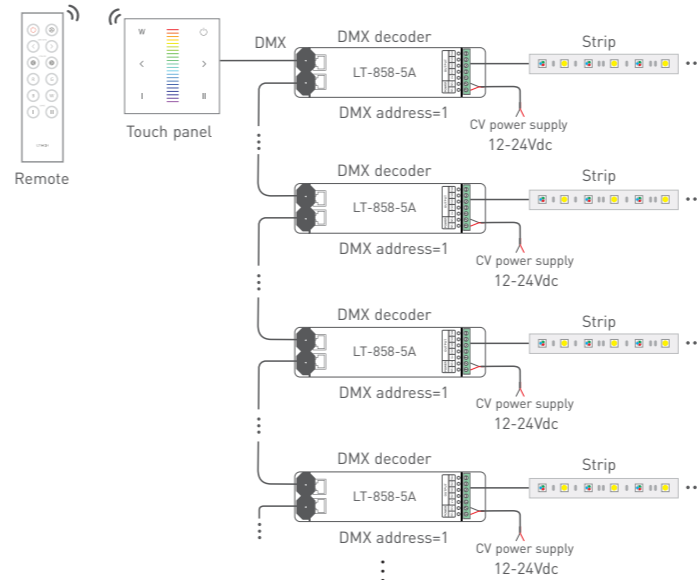

### RF wireless wiring

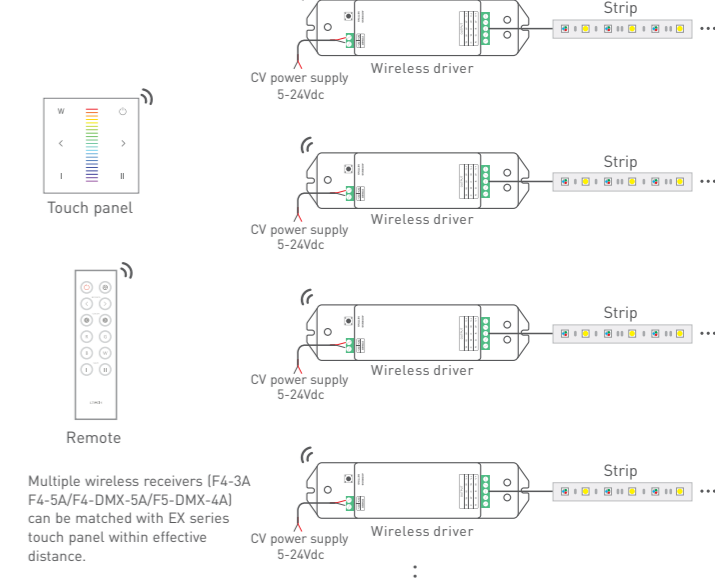

### Multi-panel control wiring

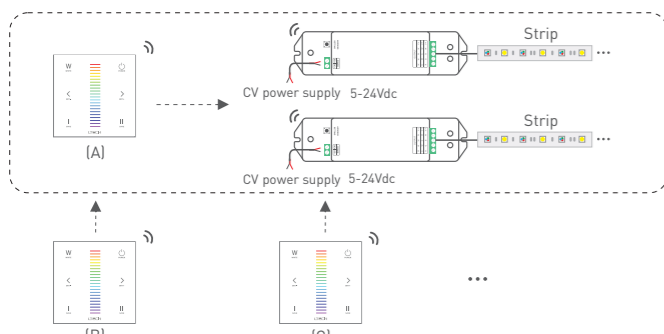

\* After touch panel A realizes controlling the lamps, if B and C are matched with A, they can also control the lamps.  
\* Linkage control is also available at connecting with DMX decoders.

### Match code between touch panels

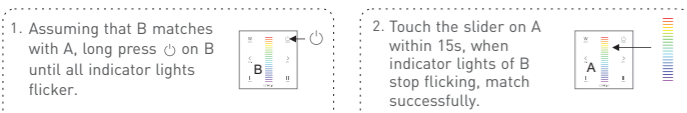

### Match code between touch panel & remote

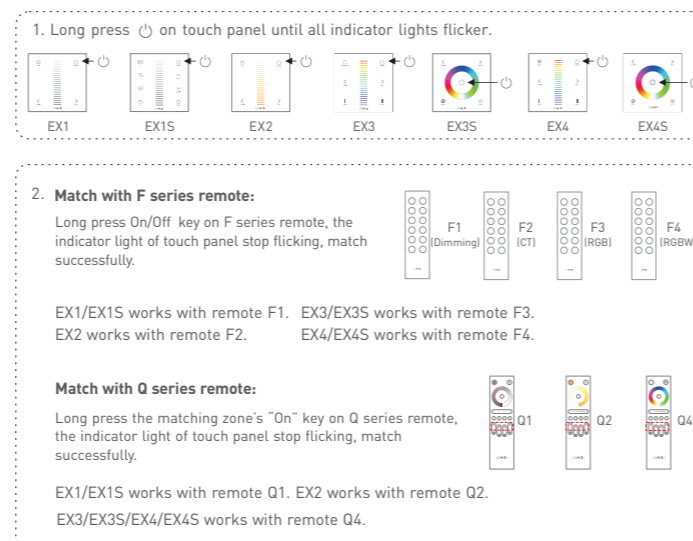

\* Please match/clear code when indicator light of panel is white.

### Match code between touch panel & wireless driver

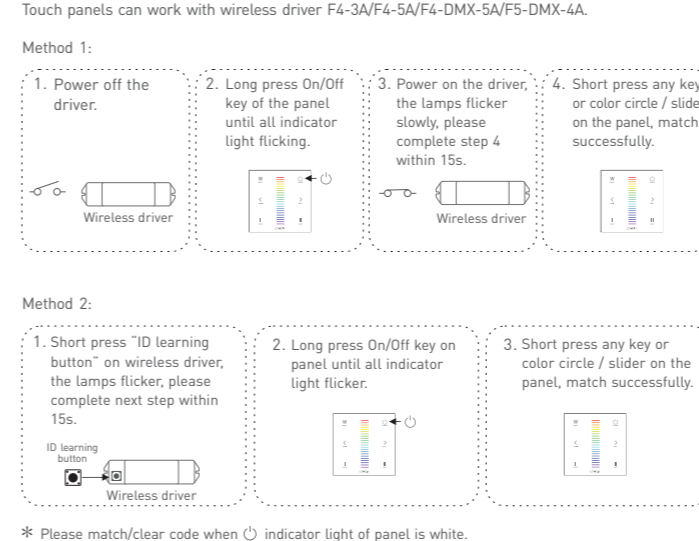

\* Please match/clear code when indicator light of panel is white.

### Match code between touch panel & gateway

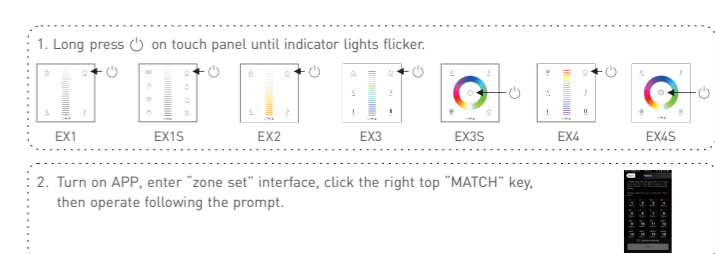

### Clear code

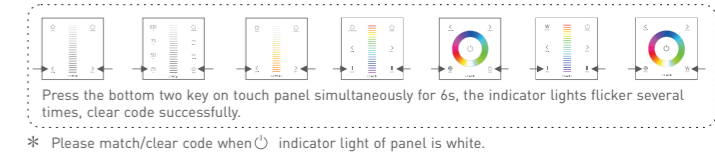

\* Please match/clear code when indicator light of panel is white.  
\* No further notice if any changes in the manual. Product function depends on the goods. Please feel free to contact our official distributor if any question.