



etiampro 

Quick Start Guide

About this Manual

The Manual includes instructions for using and managing the Product. Pictures, charts, images and all other information hereinafter are for description and explanation only. The information contained in the Manual is subject to change, without notice, due to firmware updates or other reasons. Please find the latest version of this Manual at the company website.

Please use this Manual with the guidance and assistance of professionals trained in supporting the Product.

Trademarks Acknowledgement

Trademarks and logos mentioned are the properties of their respective owners.

LEGAL DISCLAIMER

TO THE MAXIMUM EXTENT PERMITTED BY APPLICABLE LAW, THE PRODUCT DESCRIBED, WITH ITS HARDWARE, SOFTWARE AND FIRMWARE, IS PROVIDED "AS IS", WITH ALL FAULTS AND ERRORS, AND OUR COMPANY MAKES NO WARRANTIES, EXPRESS OR IMPLIED, INCLUDING WITHOUT LIMITATION, MERCHANTABILITY, SATISFACTORY QUALITY, FITNESS FOR A PARTICULAR PURPOSE, AND NON-INFRINGEMENT OF THIRD PARTY. IN NO EVENT WILL OUR COMPANY, ITS DIRECTORS, OFFICERS, EMPLOYEES, OR AGENTS BE LIABLE TO YOU FOR ANY SPECIAL, CONSEQUENTIAL, INCIDENTAL, OR INDIRECT DAMAGES, INCLUDING, AMONG OTHERS, DAMAGES FOR LOSS OF BUSINESS PROFITS, BUSINESS INTERRUPTION, OR LOSS OF DATA OR DOCUMENTATION, IN CONNECTION WITH THE USE OF THIS

PRODUCT, EVEN IF OUR COMPANY HAS BEEN ADVISED OF THE POSSIBILITY OF SUCH DAMAGES.

REGARDING TO THE PRODUCT WITH INTERNET ACCESS, THE USE OF PRODUCT SHALL BE WHOLLY AT YOUR OWN RISKS. OUR COMPANY SHALL NOT TAKE ANY RESPONSIBILITIES FOR ABNORMAL OPERATION, PRIVACY LEAKAGE OR OTHER DAMAGES RESULTING FROM CYBER ATTACK, HACKER ATTACK, VIRUS INSPECTION, OR OTHER INTERNET SECURITY RISKS; HOWEVER, OUR COMPANY WILL PROVIDE TIMELY TECHNICAL SUPPORT IF REQUIRED.

SURVEILLANCE LAWS VARY BY JURISDICTION. PLEASE CHECK ALL RELEVANT LAWS IN YOUR JURISDICTION BEFORE USING THIS PRODUCT IN ORDER TO ENSURE THAT YOUR USE CONFORMS THE APPLICABLE LAW. OUR COMPANY SHALL NOT BE LIABLE IN THE EVENT THAT THIS PRODUCT IS USED WITH ILLEGITIMATE PURPOSES. IN THE EVENT OF ANY CONFLICTS BETWEEN THIS MANUAL AND THE APPLICABLE LAW, THE LATER PREVAILS.

Regulatory Information

FCC Information

Please take attention that changes or modification not expressly approved by the party responsible for compliance could void the user's authority to operate the equipment.

FCC compliance: This equipment has been tested and found to comply with the limits for a Class B digital device, pursuant to part 15 of the FCC Rules. These limits are designed to provide reasonable protection against harmful interference in a residential installation. This equipment generates, uses and can radiate radio frequency energy and, if not installed and used in accordance with the

instructions, may cause harmful interference to radio communications. However, there is no guarantee that interference will not occur in a particular installation. If this equipment does cause harmful interference to radio or television reception, which can be determined by turning the equipment off and on, the user is encouraged to try to correct the interference by one or more of the following measures:

- Reorient or relocate the receiving antenna.
- Increase the separation between the equipment and receiver.
- Connect the equipment into an outlet on a circuit different from that to which the receiver is connected.
- Consult the dealer or an experienced radio/TV technician for help

FCC Conditions

This device complies with part 15 of the FCC Rules. Operation is subject to the following two conditions:

1. This device may not cause harmful interference.
2. This device must accept any interference received, including interference that may cause undesired operation.

EU Conformity Statement



This product and - if applicable - the supplied accessories too are marked with "CE" and comply therefore with the applicable harmonized European standards listed under the EMC Directive 2014/30/EU, the RoHS Directive 2011/65/EU.



2012/19/EU (WEEE directive): Products marked with this symbol cannot be disposed of as unsorted municipal waste in the European Union. For proper recycling, return this product to your local supplier upon the purchase of equivalent new equipment, or dispose of it at designated collection points. For more information see: www.recyclethis.info



2006/66/EC (battery directive): This product contains a battery that cannot be disposed of as unsorted municipal waste in the European Union. See the product documentation for specific battery information. The battery is marked with this symbol, which may include lettering to indicate cadmium (Cd), lead (Pb), or mercury (Hg). For proper recycling, return the battery to your supplier or to a designated collection point. For more information see: www.recyclethis.info

Industry Canada ICES-003 Compliance

This device meets the CAN ICES-3 (B)/NMB-3(B) standards requirements.



Safety Instruction

These instructions are intended to ensure that user can use the product correctly to avoid danger or property loss.

The precaution measure is divided into "Warnings" and "Cautions"

Warnings: Serious injury or death may occur if any of the warnings are neglected.

Cautions: Injury or equipment damage may occur if any of the cautions are neglected.

	
Warnings Follow these safeguards to prevent serious injury or death.	Cautions Follow these precautions to prevent potential injury or material damage.



Warnings

- Proper configuration of all passwords and other security settings is the responsibility of the installer and/or end-user.
- In the use of the product, you must be in strict compliance with the electrical safety regulations of the nation and region. Please refer to technical specifications for detailed information.
- Input voltage should conform to IEC60950-1 standard: SELV (Safety Extra Low Voltage) and the Limited Power Source with. Please refer to the appropriate documentation for detailed information.
- Do not connect several devices to one power adapter as adapter overload may cause over-heating or a fire hazard.
- Please make sure that the plug is firmly connected to the power socket. When the product is mounted on wall or ceiling, the device shall be firmly fixed.

- If smoke, odor or noise rise from the device, turn off the power at once and unplug the power cable, and then please contact the service center.



Cautions

- CAUTION: Hot parts! Burned fingers when handling the parts.



- Wait one-half hour after switching off before handling parts. This sticker is to indicate that the marked item can be hot and should not be touched without taking care. For device with this sticker, this device is intended for installation in a restricted access location, access can only be gained by service persons or by users who have been instructed about the reasons for the restrictions applied to the location and about any precautions that shall be taken.
- Make sure the power supply voltage is correct before using the camera.
 - Do not drop the camera or subject it to physical shock.
 - Do not touch sensor modules with fingers. If cleaning is necessary, use clean cloth with a bit of ethanol and wipe it gently. If the camera will not be used for an extended period, please replace the lens cap to protect the sensor from dirt.
 - Do not aim the camera at the sun or extra bright places. Blooming or smearing may occur otherwise (which is not a malfunction), and affect the endurance of sensor at the same time.

- The sensor may be burned out by a laser beam, so when any laser equipment is in using, make sure that the surface of sensor will not be exposed to the laser beam.
- Do not place the camera in extremely hot, cold (the operating temperature shall be -30°C to 60°C), dusty or damp locations, and do not expose it to high electromagnetic radiation.
- To avoid heat accumulation, good ventilation is required for operating environment.
- Keep the camera away from liquid while in use.
- While in delivery, the camera shall be packed in its original packing, or packing of the same texture.
- Regular part replacement: a few parts (e.g. electrolytic capacitor) of the equipment shall be replaced regularly according to their average enduring time. The average time varies because of differences between operating environment and using history, so regular checking is recommended for all the users. Please contact with your dealer for more details.
- This equipment is not suitable for use in locations where children are likely to be present.
- CAUTION: Risk of explosion if the battery is replaced by an incorrect type. Dispose of used batteries according to the instructions

ATTENTION: IL Y A RISQUE D'EXPLOSION SI LA BATTERIE EST REMPLACÉE PAR UNE BATTERIE DE TYPE INCORRECT. METTRE AU REBUT LES BATTERIES USAGÉES CONFORMÉMENT AUX INSTRUCTIONS

- Improper replacement of the battery with an incorrect type may defeat a safeguard (for example, in the case of some lithium battery types).
- Do not dispose of the battery into fire or a hot oven, or mechanically crush or cut the battery, which may result in an explosion.
- Do not leave the battery in an extremely high temperature surrounding environment, which may result in an explosion or the leakage of flammable liquid or gas.
- Do not subject the battery to extremely low air pressure, which may result in an explosion or the leakage of flammable liquid or gas.
- If the product does not work properly, please contact your dealer or the nearest service center. Never attempt to disassemble the camera yourself. (We shall not assume any responsibility for problems caused by unauthorized repair or maintenance.)

1 Appearance Description

Type I:

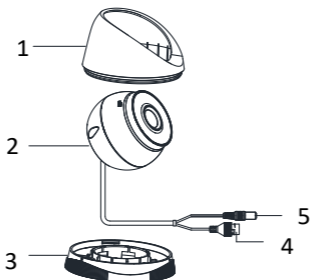

Figure 1-1 Type I Turret Camera Overview

Table 1-1 Description

No.	Description
1	Enclosure
2	Camera Body
3	Mounting Base
4	Power Cord
5	Network Cable

Type II:

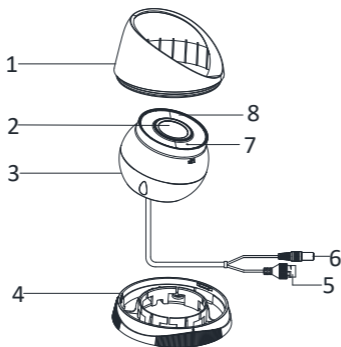

Figure 1-2 Type II Turret Camera Overview

Table 1-2 Description

No.	Description
1	Enclosure
2	Lens
3	Camera Body
4	Mounting Base
5	Network Cable

No.	Description
6	Power Cord
7	MIC
9	Front Cover

Type III:

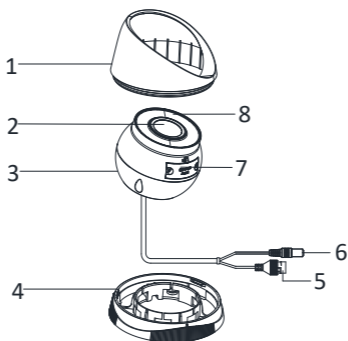

Figure 1-3 Type III Turret Camera Overview

Table 1-3 Description

No.	Description
1	Enclosure

No.	Description
2	Lens
3	Camera Body
4	Mounting Base
5	Network Cable
6	Power Cord
7	Memory Card Slot Cover
9	Front Cover

Type IV:

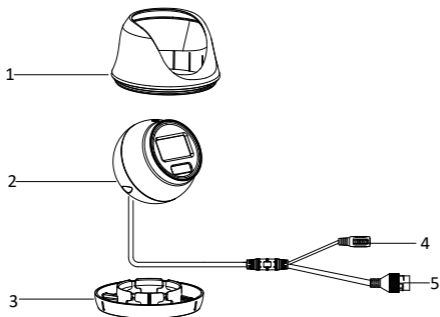

Figure 1-4 Turret Camera Overview

Table 1-4 Description

No.	Description
1	Enclosure
2	Camera Body
3	Mounting Base
4	Power Cord
5	Network Cable

Note:

For cameras support power over Ethernet (PoE), the power is passed along with data on Ethernet cabling. And a switch supports PoE function is required.

2 Installation

Before you start:

- Make sure the device in the package is in good condition and all the assembly parts are included.
- The standard power supply is PoE or 12 VDC, make sure your power supply matches with your camera.
- Make sure all the related equipment is power-off during the installation.
- Check the specification of the products for the installation environment.
- Make sure that the wall is strong enough to withstand four times the weight of the camera and the bracket.
- Make sure that there is no reflective surface too close to the camera lens. The IR light from the camera may reflect back into the lens causing reflection.

2.1 Memory Card Installation

Only type III camera supports memory card installation, you can follow the steps to mount and unmount the memory card.

Steps:

1. Rotate the camera to expose the memory card slot.
2. Loosen the screws to remove the memory card slot cover.

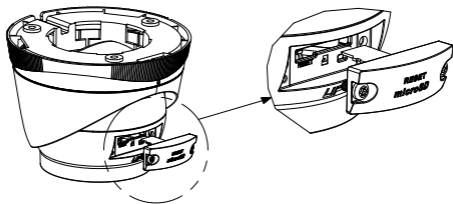

Figure 2-1 Unscrew the Cover and Insert Memory Card

3. Insert the memory card into the memory card slot.
4. (Optional) To unmount the memory card, push to get it ejected.
5. Screw the cover back to the camera.

2.2 Ceiling Mounting

Note:

This camera series shares the same installation method, and we take type IV turret camera as the example to illustrate the installation.

Before you start:

Both wall mounting and ceiling mounting are suitable for the turret camera. Ceiling mounting will be taken as an example in this section. And you can take steps of ceiling mounting as a reference for wall mounting.

Steps:

1. Paste the drill template (supplied) to the desired mounting position on the ceiling.

2. Drill the screw holes and the cable hole in the ceiling according to the drill template.

Note:

Drill the cable hole, when adopting ceiling outlet to route the cable.

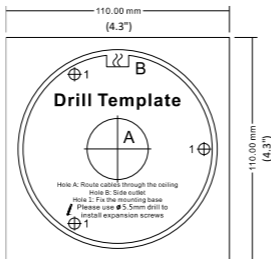

Figure 2-2 The Drill Template

3. Disassemble the camera.

- 1). Rotate the camera to align the notch to one of the marks.
- 2). Pry the mounting base to remove the mounting base with the camera body with a flat object, e.g., a coin.

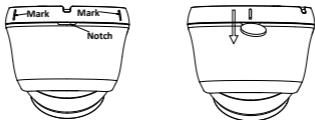

Figure 2-3 Disassemble the Camera

4. Fix the mounting base to the ceiling with supplied screws.

Notes:

- In the supplied screw package, both self-tapping screws, and expansion bolts are contained.
- If the ceiling is cement, expansion bolts are required to fix the camera. If the ceiling is wooden, self-tapping screws are required.

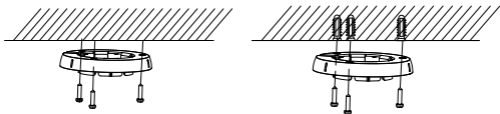

Figure 2-4 Fix the Mounting Base

5. Route the cables through the cable hole or the side opening.

6. Install the camera body back to the mounting base.

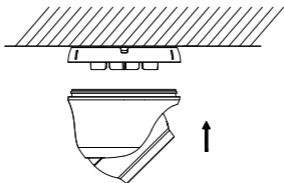

Figure 2-5 Install the Camera Body

7. Connect the power cord and network cable.

- Power on the camera, and set the network configuration (for details, refer to *3 Activate and Access Network Camera*) to check whether the image is gotten from the optimum angle. If not, adjust the surveillance angle.

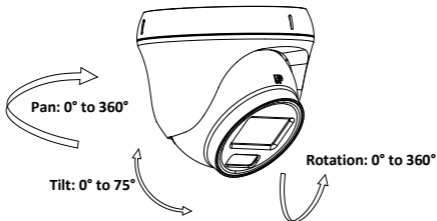

Figure 2-6 Adjust Surveillance Angle

- Hold the camera body and rotate the enclosure to adjust the pan angle [0° to 360°].
- Move the camera body up and down to adjust the tilt angle [0° to 75°].
- Rotate the camera body to adjust the rotation angle [0° to 360°].

2.3 Mounting with Junction Box

Before you start:

- You need to purchase a junction box separately if you adopt the mounting with a junction box.

- Both wall mounting and ceiling mounting are suitable for the turret camera. Wall mounting will be taken as an example in this section. And you can take steps of wall mounting as a reference for the ceiling mounting.

Steps:

- Paste the drill template (supplied) to the desired mounting position on the wall.
- Drill the screw holes and the cable hole in the wall according to the drill template.

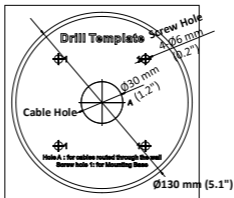

Figure 2-7 Drill Template

- Take apart the junction box, and fix the mounting base with three PM4 screws on the cover of junction box.

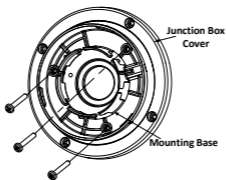

Figure 2-8 Fix Mounting Base

- Secure the body of junction box on the wall with four PA4 × 25 screws.

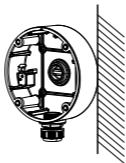

Figure 2-9 Secure the Body of Junction Box on the Ceiling/Wall

- Combine the cover of junction box with its body with supplied screws.
- Repeat steps 5 to 8 of *2.2 Ceiling Mounting* to complete the installation.

2.4 Mounting with Inclined Base

Before you start:

- You need to purchase an inclined base separately if you adopt the mounting with an inclined base.
- Both wall mounting and ceiling mounting are suitable for the turret camera. Wall mounting will be taken as an example in this section. And you can take steps of wall mounting as a reference for the ceiling mounting.

Steps:

- Paste the drill template to the wall.

2. Drill screw holes and the cable hole (optional) on the wall according to the supplied drill template.

Note:

Drill the cable hole, when adopting ceiling outlet to route the cable.

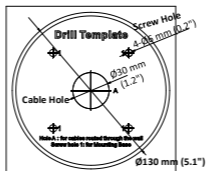

Figure 2-10 Drill Template

3. Disassemble the inclined base by the screwdriver.
4. Install the mounting base of turret camera on the inclined base cover with three PM4 screws.

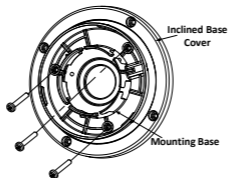

Figure 2-11 Fix Mounting Base

5. Install the body of inclined base on the ceiling/wall with four PA4 × 25 screws.

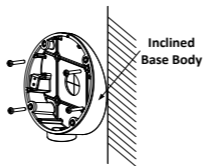

Figure 2-12 Fix the Body of Inclined Base on Ceiling/Wall

6. Combine the cover of inclined base with its body with supplied screws.
7. Repeat steps 5 to 8 of 2.2 *Ceiling Mounting* to complete the installation.

2.5 Wall Mounting

Note:

You need to purchase a wall mounting bracket separately.

Steps:

1. Drill four $\varnothing 10$ mm screw holes in the wall according to the holes of the bracket.
2. Install the bracket on the wall by aligning the four screw holes of the bracket with M6 expansion screws on the wall.

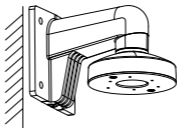

Figure 2-13 Install the Wall Mounting Bracket

3. Install the mounting base of the camera to the wall mounting bracket and secure them with supplied screws.

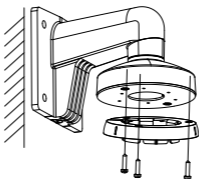

Figure 2-14 Install the Mounting Base on the Wall Mounting Bracket

4. Repeat steps 5 to 8 of 2.2 *Ceiling Mounting* to complete the installation.

2.6 Install Network Cable Waterproof Jacket

If the camera is installed outdoor, you should use the waterproof accessory to waterproof the network cable. Otherwise, the cable might get wet or a short circuit occurs.

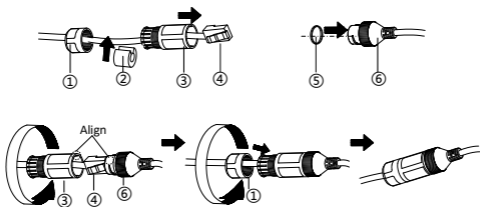

Figure 2-15 Install Waterproof Jacket

Steps:

1. Feed the network cable through ① and ③ in order.
2. Fix ② on the network cable between ① and ③.
3. Place ⑤ onto the end of ⑥, and plug the RJ45 male connector into RJ45 female connector.
4. Screw ③ to ⑥ clockwise.
5. Push ② into ③.
6. Secure ① with the ③ in clockwise direction.

3 Activate and Access Network Camera

Scan the QR code to get *Activate and Visit Network Camera*. Note that mobile data charges may apply if Wi-Fi is unavailable.





etiampro 

Made in PRC
Imported by Velleman Group nv
Legen Heirweg 33, 9890 Gavere, Belgium
www.velleman.eu