

Glass control modules

**VMBGP1 / VMBGP2 / VMBGP4 / VMBGPOD /
VMBGP4PIR**

User Manual

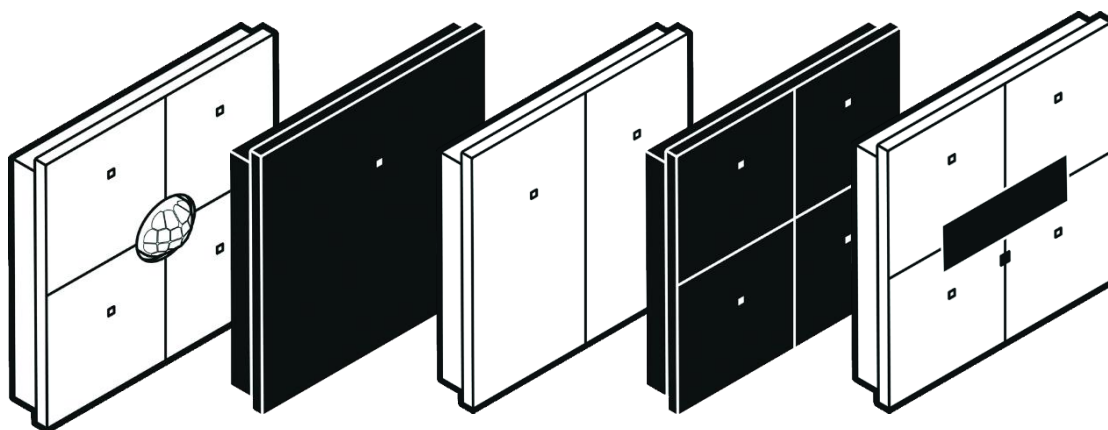
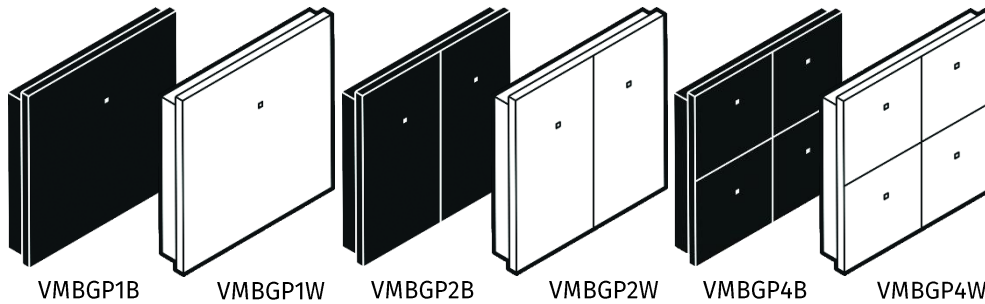

Table of Contents

1. The glass control module range.....	3
2. Characteristics.....	4
2.1. Common characteristics.....	4
2.2. Specific characteristics of the VMBGP4PIR.....	4
2.3. Specific characteristics of the VMBGPOD.....	5
3. How do I do this?.....	6
4. Operating the VMBGPOD.....	7
4.1. Overview.....	7
4.2. Operating the thermostats on the VMBGPOD.....	8
5. Configuration using Velbuslink.....	11
5.1. Configuration of the VMBGP1, VMBGP2 and VMBGP4.....	12
5.2. Configuration of the VMBGPOD:.....	25
5.3. Configuration of the VMBGP4PIR.....	33
6. Configuration of the VMBGPOD via the OLED screen.....	35
6.1. Configuration of push buttons.....	35
6.2. Configuration of pulse counters.....	35
6.3. Configuration of thermostats.....	36
6.4. Clock configuration.....	37
7. Appendix A - VMBGPOD detailed thermostat configuration.....	38
8. Appendix B - VMBGPOD changing a thermostat program step using the oled configuration menu.....	39

1. The glass control module range

- with 1, 2 and 4 touch keys



- with OLED screen

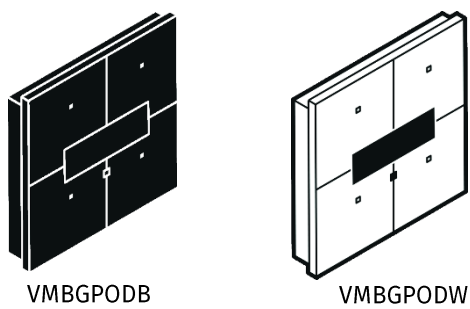

- with 4 touch keys and built-in twilight and motion sensor

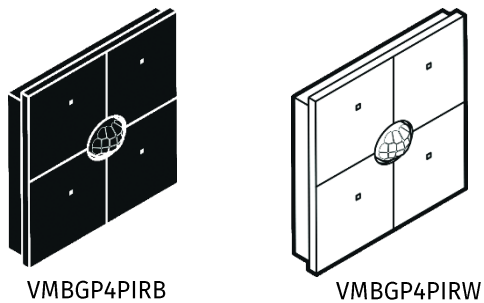

2. Characteristics

2.1. Common characteristics

Most characteristics of the glass control modules are standard for the entire range. These include:

- 1, 2 or 4 **touch keys** (depending on the model)
- **dual and multi-button operation** (the VMBGPOD does not have multi-button mode, and only has dual button mode on the first page¹)
 - dual operation: short press activates one function, long press activates another. The duration for long press can be set at 1, 2, or 3 seconds (see p. 17)
Example: short press is ON, long press for the same button is OFF.
 - multi-button operation: a new function is activated every time the button is pressed. Depending on the model, a series of 4 (VMBGP4) up to 7 (VMBGP1) functions can be set (see p. 17)
Example: setting the ventilation speed with a single button. Press once to set low speed, press twice to set medium speed, press three times for high speed, press four times to turn OFF. Press again to start up the cycle again.
- a built-in **temperature sensor and thermostat operation**
 - every glass control module can be used to measure the temperature in the room as well as for heating and cooling control. The target temperature and operating mode (frost protection, day, night or comfort) can be selected through manual operation or program steps. The thermostats of other glass control modules can be displayed and operated (max. 12 modules) on a VMBGPOD (with OLED screen).
Example: a residence has a glass control module in every room, allowing for manual as well as automatic operation of both heating and cooling. An extra thermostat is no longer necessary.
- automatic operation via **program steps**
 - certain functionalities can be performed automatically at specific times (daily, weekly, only on weekdays, only on weekends, etc.). The selected time can be fixed (specific time of day), or linked to sunrise and sunset times.
Example: via a program step on a glass control module the blinds are automatically raised at sunrise.
 - buttons can be (temporarily) locked so they cannot be operated
Example: during office hours the buttons in the private area of a doctor's surgery are temporarily locked so patients cannot operate them inadvertently. Naturally this functionality can be activated or deactivated manually at the press of a button.
 - heating and cooling can also be automated via program steps
Example: on weekdays the heating is set to day mode every morning between 6.30 and 8.30 am and every evening between 4 pm and 10.30 pm. Outside these hours night mode is activated automatically. On the weekends a different program is used. The temperature can be adjusted as necessary by pressing a button.
- high and low **temperature alarms** (4 in total)
 - when the temperature is higher or lower than a specific value, a specific action can be performed.
Example: when the temperature exceeds 25°C the blinds are lowered automatically. Conversely, when the temperature is lower than 19°C they are raised automatically.

2.2. Specific characteristics of the VMBGP4PIR

In addition to 4 touch keys, the VMBGP4PIR is also equipped with a built-in twilight and motion sensor (PIR). This sensor has the following characteristics:

- light/dark output (twilight detection)
- motion detection with adjustable timers
- light-dependent motion detection: reaction to movement *only when it is dark enough*. With adjustable twilight threshold

¹ Firmware 1640 and higher, firmware upgrade can be done free of charge with Velbuslink

- absence detection: this channel is closed when no movement is detected for a certain period of time

The 4 touch keys of the VMBGP4PIR can be configured to work as a single button.

2.3. Specific characteristics of the VMBGPOD

- the following can be displayed on the OLED screen of the VMBGPOD:
 - up to 8 pages of 4 push buttons. A name and/or icon can be set for each button to clarify its function.
 - a clock page with date and time, both of which can be adjusted
 - for every connected glass control module a thermostat page with the current temperature, mode (day, night, frost protection, ...), target temperature and other information on heating and cooling. Every thermostat can also be operated (set to day/night/comfort/frost protection; temporarily raise or lower the temperature, ...)
 - current consumption, day total and total consumption of the connected pulse counters (for more details please consult the documentation of the VMB7IN 7-channel input module)
 - readouts of analog sensors (VMBMETEO and VMB4AN)
- the OLED screen can also be used to
 - adjust program steps
 - lock or unlock the push buttons
 - change the target temperatures for heating and cooling
 - change from heating mode to cooling mode and vice versa

3. How do I do this?

How do I configure my glass control modules?

Like the other Velbus modules, the glass control modules are also configured in the Windows program Velbuslink. For general information on the use of Velbuslink, please read Part 2: Programming of the Velbus Installation Guide.

For a description of the settings of the glass control modules go to p.11.

The glass control modules with OLED screen VMBGPODx can also be configured on the module itself via the OLED screen (see p.35).

How do I operate the thermostat?

See p. 8.

How do I add a page with push buttons to a VMBGPOD?

Per 8 push buttons (2 pages of 4 push buttons each) an address must be assigned to the VMBGPOD. This is done in the Velbuslink software. A maximum of 4 addresses for push buttons can be assigned per VMBGPOD (so a total of 32 push buttons). For more details on addressing in Velbus please consult the Velbus Installation Guide.

For every page of push buttons the user can choose whether or not to display it (see p. 25).

How do I edit the date and time on my VMBGPOD?

To access the clock page it must be activated in Velbuslink (see p. 29).

To edit the date and time, leave the clock page and bring up the configuration screen. See the detailed instructions on p.37.

How do I display the kWh counter (or another pulse counter) on my OLED screen?

- connect your kWh pulse counter with a VMB7IN module
- In Velbuslink² open the configuration settings of the VMB7IN, go to “counters” tab, select the input channel in question, press “edit” and select the appropriate resolution of your counter (depending on the model of the pulse counter)
- open the configuration settings of the VMBGPOD in Velbuslink, go to the “counters” tab (see p.32), click on “add” and select the counter from the list

As soon as the changes have been saved to the modules (synchronise) a counter page will be made available on your OLED screen. This page displays the name of the counter, the current consumption, the day total and the total consumption since the counting started.

To edit the name of the counter, change the name of the VMB7IN channel in question using Velbuslink².

See also

- the Velbus Installation Guide, Part 1 and Part 2 (free download at www.velbus.eu)
- www.velbus.eu > support

² For a general explanation on Velbuslink, please read Part 2: Programming of the Velbus Installation Guide.

4. Operating the VMBGPOD

4.1. Overview

Every glass control module with OLED screen (VMBGPOD) features 7 touch-sensitive zones (see image below).

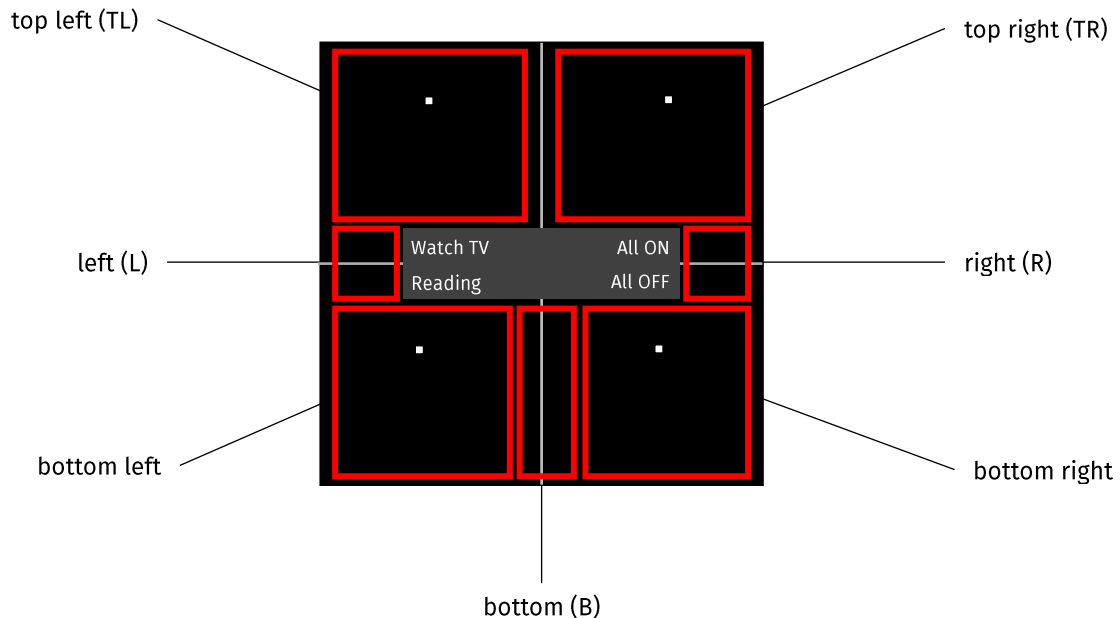

- The zones “**top left**”, “**top right**”, “**bottom left**” and “**bottom right**” are used to operate the buttons. In the configuration menu they are also used to adjust the settings.
- The zones “**left**” and “**right**” are used to navigate between different pages (pages of buttons and, if activated, thermostats, pulse counters and the clock page). Long press (> 5s) will activate the cleaning mode during 1 minute, as indicated by the spraybottle icon. During cleaning mode the buttons are locked, so the glass panel can be safely cleaned without operating the buttons.
- With long press (> 5s), the zone “**bottom**” opens the configuration menu. With short press, it can be used to navigate between page groups, provided this functionality is activated (see p.30). Please consult the diagram below.

OPTION 1: only "left" and "right" are used

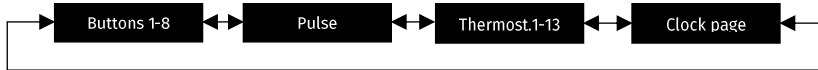

OPTION 2: use "left" and "right" within a page group, and "bottom" to navigate between the page groups

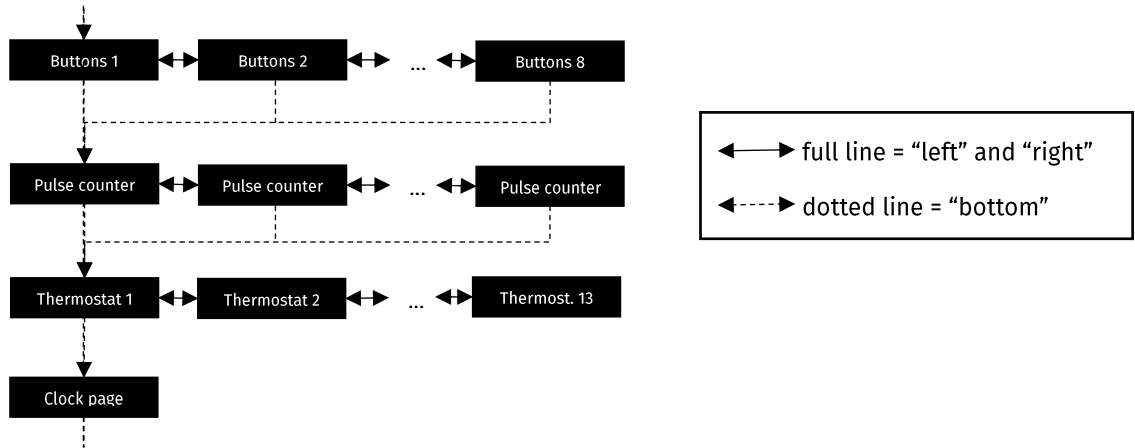

4.2. Operating the thermostats on the VMBGPOD

Overview of the thermostat screen

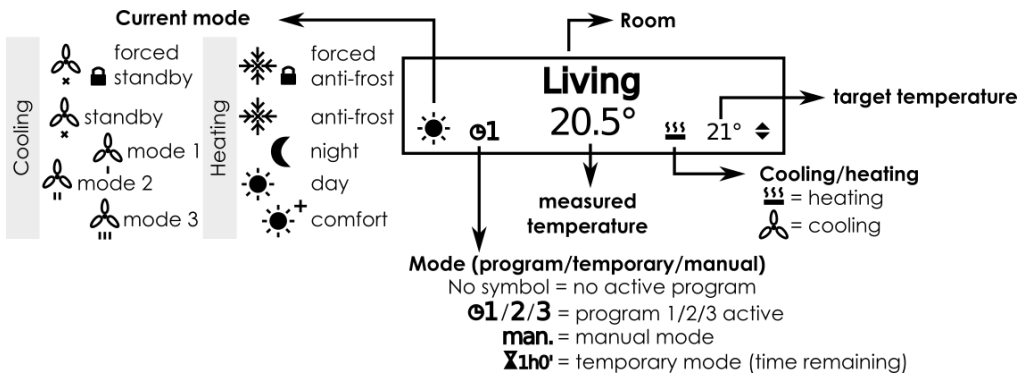

Operating the thermostat

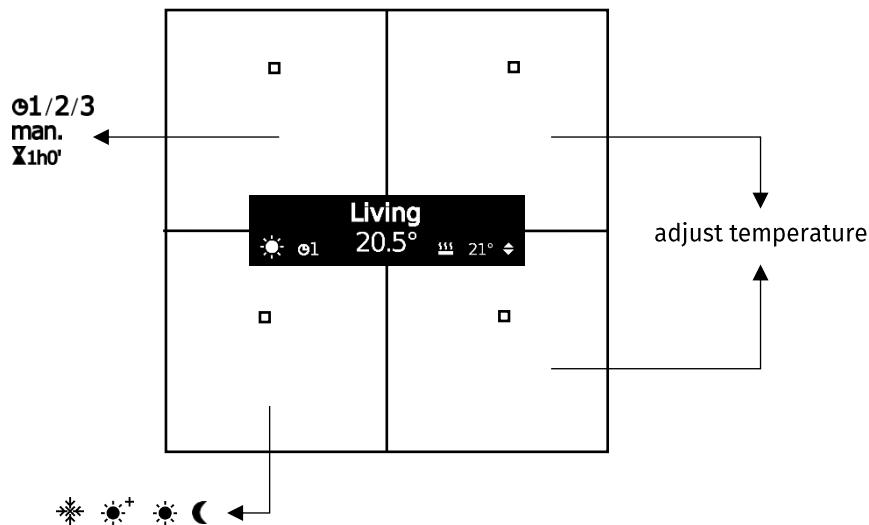

- the bottom left button can be used to change the mode of the thermostat (day/night/comfort/standby)
- the bottom and top right buttons can be used to raise or lower the current temperature. How long this adjustment remains in effect depends on the setting “automatic/temporary/manual” (see next section)
- the top left button enables the user to choose between:
 - **automatic operation** (standard): the program steps are followed. A clock icon appears displaying the number of the active program (1, 2 or 3). For more details on programs, please consult Part 2: Programming of the Velbus Installation Guide.
 - **temporary operation**: manual adjustments to temperature and mode (using the buttons at the left and right bottom) remain in effect during the specified period, after which the automatic operation is restored. If program steps are active, after the temporary mode the thermostat will revert to the state that has to be active according to the program steps. If no program steps are active, the thermostat will return to the state that was active before the temporary mode. An hourglass icon is displayed in the bottom left-hand corner next to the remaining time. The duration of the temporary operation is set by long press on “bottom” and then adjusting the “Timer” setting.
E.g. if you want to turn up the heating by one degree for one hour: Press top left to activate the thermostat’s temporary mode, then top right to raise the temperature. During temporary operation the feedback LEDs will blink slowly.
 - **manual operation**: the program steps are no longer followed. The message “man.” is displayed in the bottom left-hand corner of the OLED screen. Adjustments to temperature and mode (using the bottom left and top and bottom right buttons) remain in effect until they are adjusted manually again, or until temporary or automatic operation is restored. **Use manual operation carefully: for instance, if the thermostat is set to comfort mode and manual operation then the heating will remain in comfort mode until you yourself change this.**

When the thermostat page is activated, the feedback LEDs indicate the status of the heating/cooling:

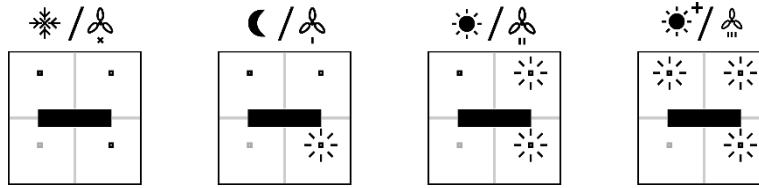

- the bottom left feedback LED is lit when the heating or cooling is activated (channel “heating” or “cooling” is ON)
- the other three feedback LEDs indicate the active mode:
 - only bottom right is lit: night / cooling setting 1
 - top and bottom right are lit: day / cooling setting 2
 - top and bottom right and top left are lit: comfort / cooling setting 3
 - all OFF: standby / no cooling
 - during temporary operation these LEDs will blink slowly

To adjust the heating/cooling settings, please read p. 18 and p.36.

5. Configuration using Velbuslink



For a general explanation on how to install and configure Velbus, please refer to the installation guide at www.velbus.eu.



Always use the latest version of Velbuslink (free download at www.velbus.eu > Support > Downloads).

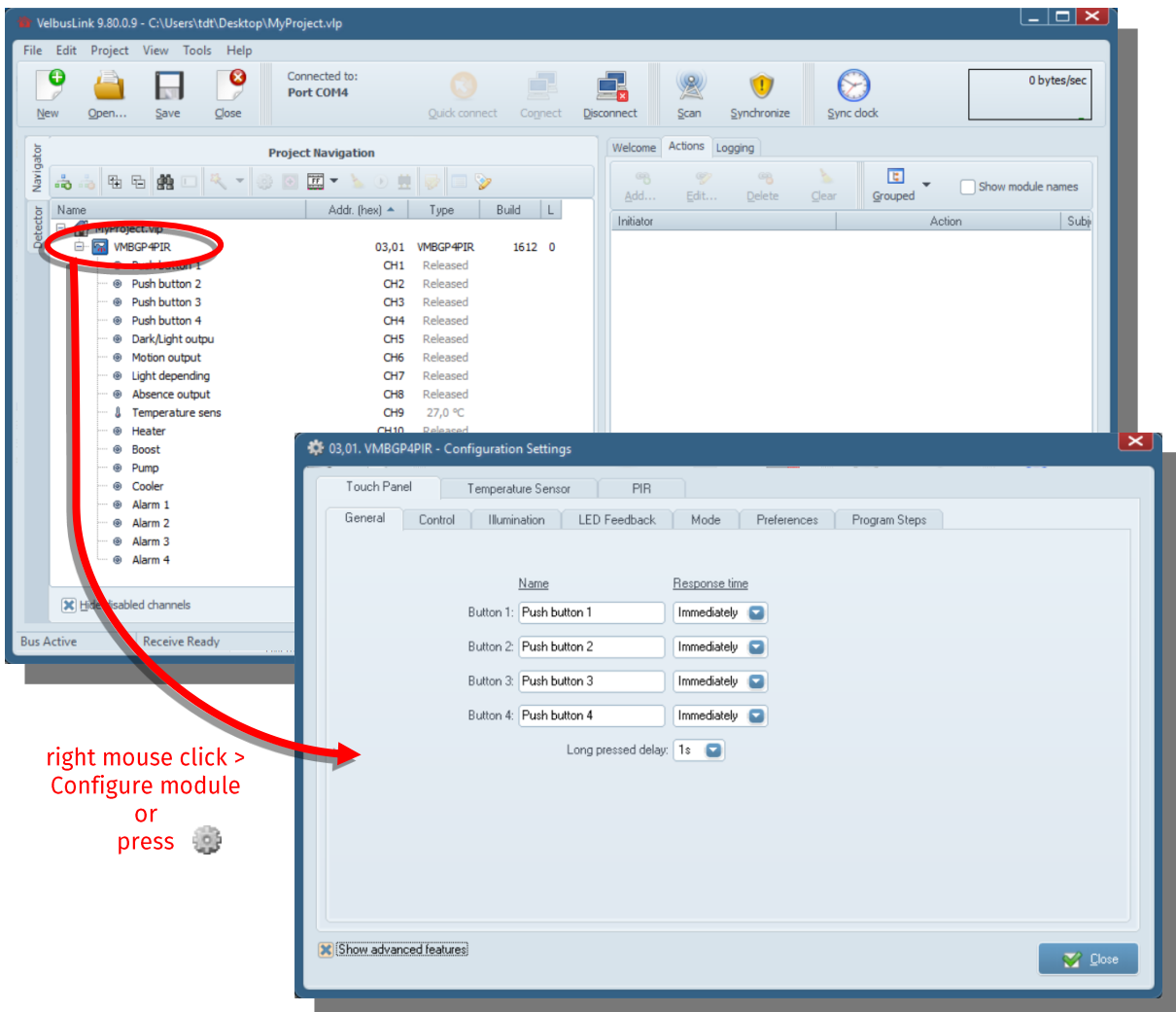

The screenshot displays the VelbusLink 9.80.0.9 software interface. The main window shows a project navigation tree on the left with the 'VMBGP4PIR' module selected. A red circle highlights this module, and a red arrow points from it to the '03_01. VMBGP4PIR - Configuration Settings' dialog box. The dialog box has tabs for 'Touch Panel', 'Temperature Sensor', and 'PIR'. The 'PIR' tab is active, showing configuration options for four buttons and a long pressed delay.

right mouse click >
Configure module
or
press 

5.1. Configuration of the VMBGP1, VMBGP2 and VMBGP4

VMBGP1/VMBGP2/VMBGP4 – Touch screen > General

Push buttons

These push buttons correspond with actual push buttons on the glass control modules. Their names can be edited here.

Virtual push buttons

These are virtual push button channels. They do not correspond with an actual push button on the glass control module but can be used for program steps, dual operation, multi-button operation, etc.

Certain actions (e.g. dimming and operating blinds) distinguish between short and long press. The duration of long press can be set here (1s or 2s).

Attention: this setting is independent of the setting “duration long press” in case of dual operation (see p. 17).

Set the response time of the button here (instantaneous, 1s, 2s, 3s, never).
 Example: set the response time to 2s to prevent “everything OFF” being operated by accident. The button will only react when it is held for 2s.

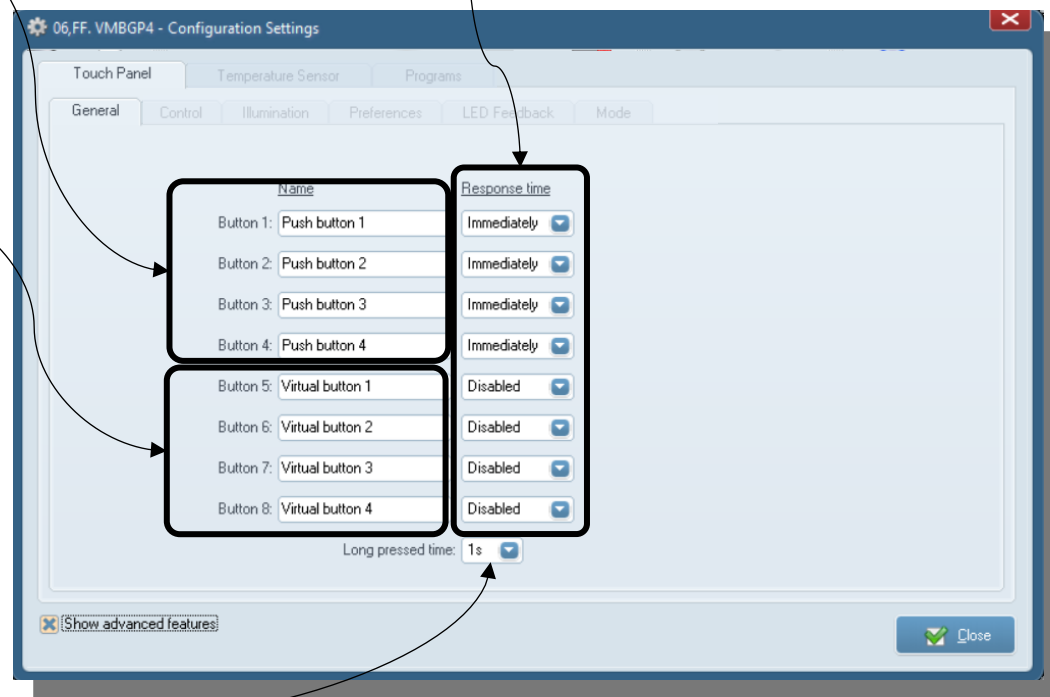

The settings “mode cycle button” and “sensor feedback” are only available if the thermostat has been assigned an address. Please consult the Velbus Installation Guide for more details.

Mode cycle button
When this option is checked, push button 4 (bottom left) will toggle the thermostat between comfort, day, night and frost protection.

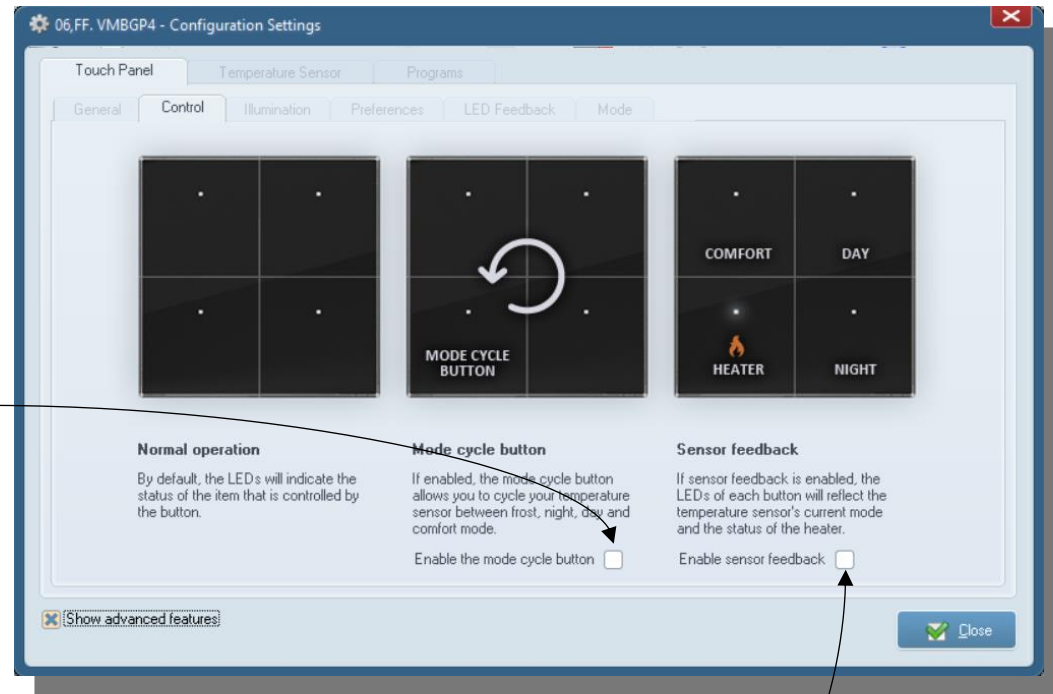

Sensor feedback
When this option is checked the feedback LEDs indicate the status of the heating or cooling (see also p.9 and beyond).

VMBGP1/VMBGP2/VMBGP4 – Touch screen > Lighting



LED backlighting
When the LEDs are not giving feedback, they can either be OFF or lit dimly (to serve as an orientation light, for aesthetic reasons or to act as night lighting).

Check the box for those push buttons that must be backlit.

Set the backlighting level here (low, medium or high).

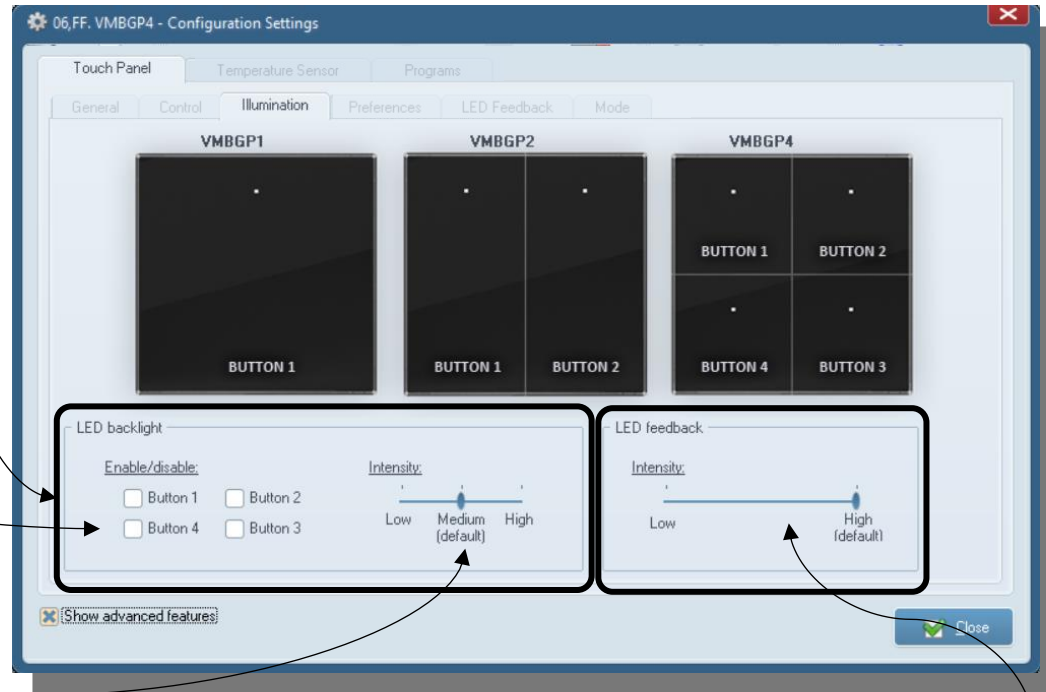

LED feedback
The LEDs indicate the status of the connected outputs.
Example: when a button toggles a light ON and OFF, the feedback LED will be lit when the light is ON; it will be extinguished when the light is OFF. (This behaviour can also be changed, see p.17).
Set the level of the feedback LEDs here (low or high).

Choose here whether the module must produce an audible click when a button is tapped.

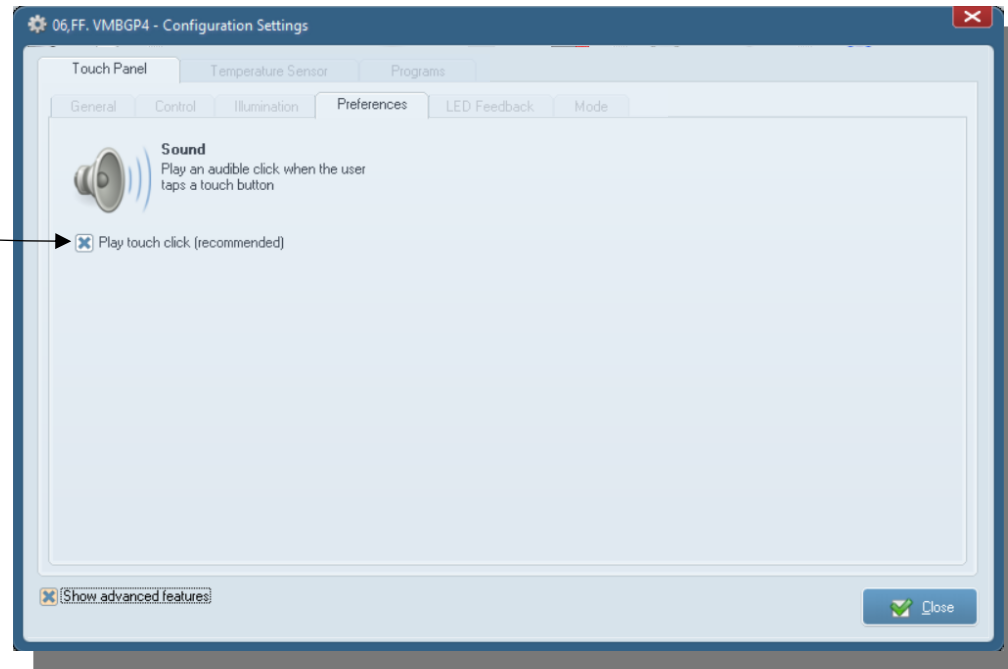



LED behaviour

Feedback LEDs can be ON continuously, blink slowly, blink fast or blink very fast.

Examples of standard operation:

- the feedback LED for an ON/OFF button is lit continuously as long as the connected output is ON
- the feedback LED blinks slowly when a timer is running
- the feedback LED blinks fast when a dimmer is dimming
- very fast blinking only occurs with older modules that use rotary switches

To keep the feedback LED lit continuously instead of letting it blink, double click on a button and uncheck the unwanted blinking behaviour.

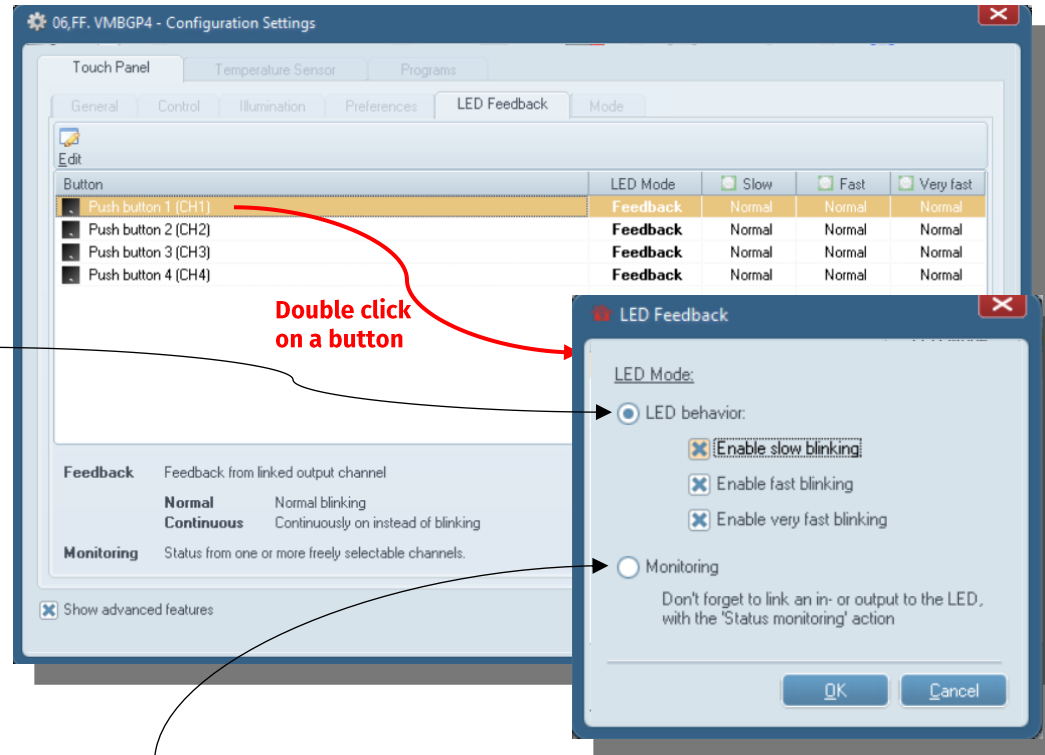

Monitoring

By default the feedback LED indicates the status of the outputs that are connected with the push button. You can change this here.

Example: a button in the living room turns the light in the living room ON and OFF. Instead of the status of the light in the living room, you want the feedback LED to indicate the status of the light in the nursery.

To have the feedback LED indicate the status of a different output than the one to which it is connected, choose the “Monitoring” option.

Then use the “Status monitoring” action with the output to be monitored (light in the nursery) as the initiator and the push button (in the living room) as the subject. Please refer to the Velbus Installation Guide for a detailed explanation on how to re-couple LED feedbacks.

Push button operation

The touch keys on the glass control modules (with the exception of the VMBGPOD modules with OLED screen) can be set to dual operation or multi-button operation.

- dual operation: short press has a different function than long press.
E.g. short press is "ON", long press is "OFF"
- multi-button operation: repeatedly pressing the same button activates a different function every time
E.g. pressing once sets the ventilation to "low", pressing twice sets it to "medium". Press three times for "high" and four times for "OFF".

The duration for long press can be set at 1, 2 or 3 seconds.

Double operation and multi-button operation are configured in the same way on all Velbus input modules. Please refer to the Velbus Installation Guide for more details.

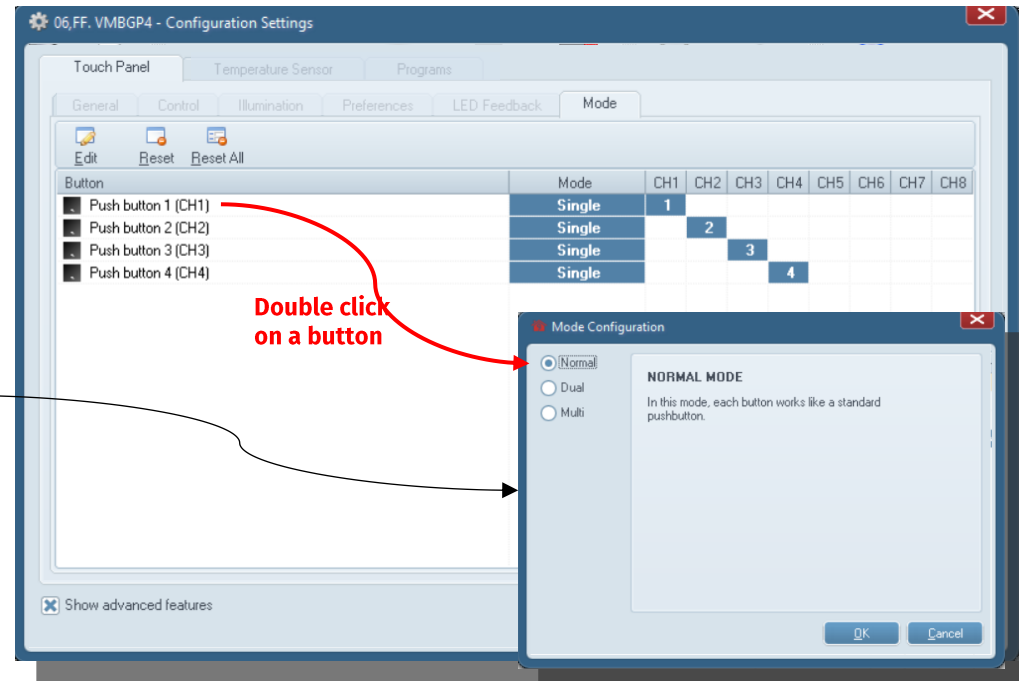

VMBGP1/VMBGP2/VMBGP4 – Temperature sensor > General



The temperature settings only apply if the temperature sensor has been assigned an address. For more details on how to control heating and cooling, please refer to the Velbus Installation Guide.

Sensor name
Here you can name the temperature sensor (e.g. "living room"). This name will be displayed in Velbuslink and on the OLED screen of VMBGPOD control modules.

Heating

- max/min range: with manual operation the temperature can only be set between these limit values
Example: the "max. range" of the temperature sensor in the children's room is set to 22°C. This way the children cannot set a higher temperature than 22°C in their room.
- comfort, day, night, standby: here you can set the target temperature per operating mode.

Airco
At winter's end, the thermostat operation can be switched from heating to cooling (with a push button, via the OLED screen of a VMBGPOD, or automatically via program steps). The settings for the airco are analogous with those for the heating (see above).

Settings for heating

Settings for cooling

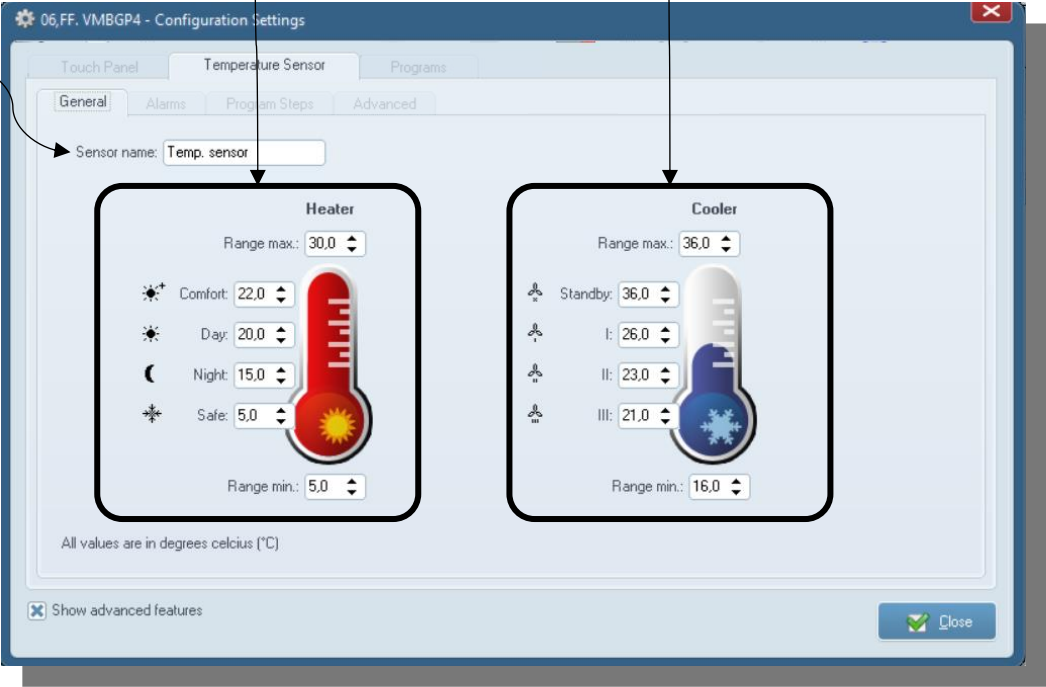

VMBGP1/VMBGP2/VMBGP4 – Temperature sensor > Alarms



The temperature settings only apply if the temperature sensor has been assigned an address. For more details on how to control heating and cooling, please refer to the Velbus Installation Guide.

Temperature alarms

These settings concern channels “Alarm 1” through “Alarm 4”. These channels will be blocked when the set temperature limits are exceeded.

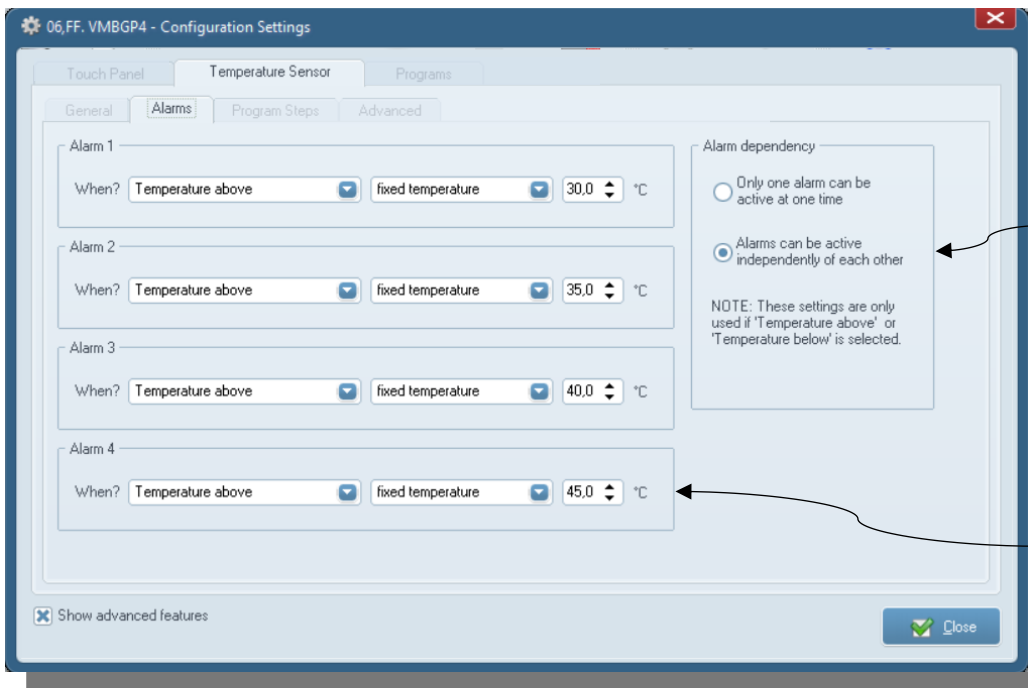

Alarm options

Determines whether or not multiple alarms can be closed at the same time.

Attention! In case of operation “only 1 alarm can be activated at once” the order of activation is important: alarm 4 takes priority over alarm 3, which takes priority over alarm 2, etc. See also p. 19.

Set the limit values above or below which the alarm channels should be closed.

- “Fixed temperature” is an absolute value (e.g. 25°C).
- “Target temperature +/- value” is relative to the target temperature (the entered value is added to the target temperature to determine the limit value)

VMBGP1/VMBGP2/VMBGP4 – Temperature sensor > Program steps

The temperature settings only apply if the temperature sensor has been assigned an address. For more details on how to control heating and cooling, please refer to the Velbus Installation Guide.

Please refer to the Velbus Installation Guide for more details on program steps.

Program steps

In this tab, program steps can be entered in order to automate the heating and/or cooling.

Example: in the screenshot below the heating on weekdays is set to the day program between 6.30 and 8.30 am and between 3.30 pm and 10.30 pm. On the weekend this is the case between 7.30 am and 11.30 pm.

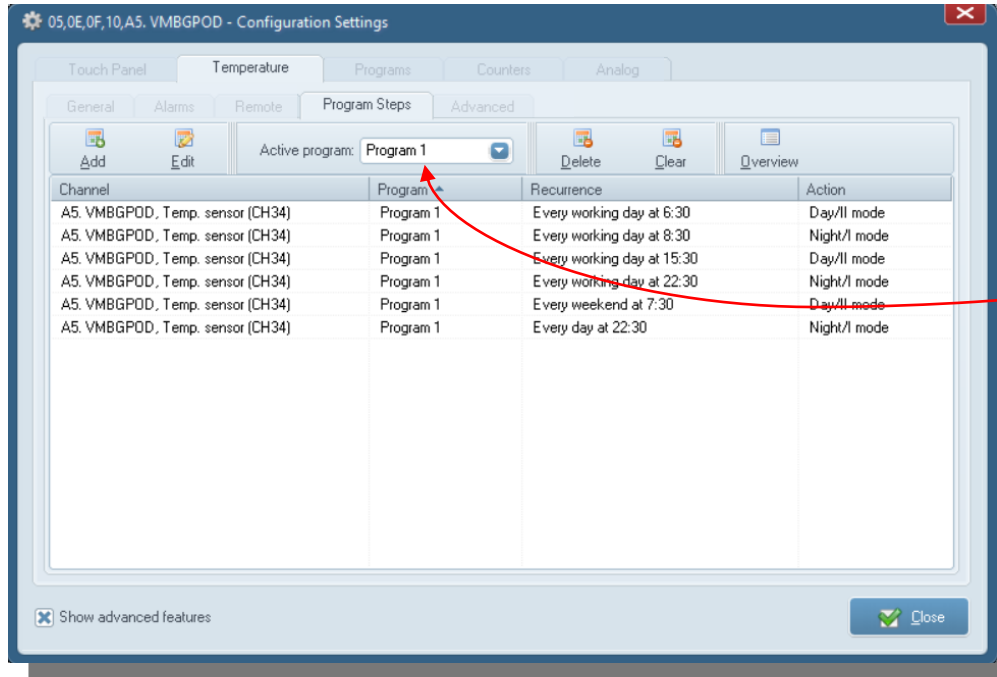

05,0E,0F,10,A5, VMBGP0D - Configuration Settings

Touch Panel | Temperature | Programs | Counters | Analog

General | Alarms | Remote | Program Steps | Advanced

Add | Edit | Active program: Program 1 | Delete | Clear | Overview

Channel	Program	Recurrence	Action
A5, VMBGP0D, Temp. sensor (CH34)	Program 1	Every working day at 6:30	Day/! mode
A5, VMBGP0D, Temp. sensor (CH34)	Program 1	Every working day at 8:30	Night/! mode
A5, VMBGP0D, Temp. sensor (CH34)	Program 1	Every working day at 15:30	Day/! mode
A5, VMBGP0D, Temp. sensor (CH34)	Program 1	Every working day at 22:30	Night/! mode
A5, VMBGP0D, Temp. sensor (CH34)	Program 1	Every weekend at 7:30	Day/! mode
A5, VMBGP0D, Temp. sensor (CH34)	Program 1	Every day at 22:30	Night/! mode

Show advanced features | Close

Do not forget to select the active program!
This is only possible if Velbuslink is connected.

The temperature settings only apply if the temperature sensor has been assigned an address. For more details on how to control heating and cooling, please refer to the Velbus Installation Guide.

Setting

Hysteresis: guarantees that the heating/cooling won't turn ON or OFF constantly

Boost difference: the "Boost" channel is closed when the difference between the measured temperature and the target temperature is equal to or larger than this value

Min. switching time: the minimum amount of time that must pass between two status changes. Applies to all temperature channels, including the temperature alarms.

E.g.: this is the minimum duration for which the heating channel must be open before it can be closed again, and vice versa.

Calibration offset: this value (positive or negative) is added to the measured temperature

Example: if the measured temperature is systematically 2°C high then fill in -2°C to correct the measurement.

Pump

Pump-on & pump-off delay: optional protection against idling pump

Blocking protection (enable unjamming): closes the channel "heating" (valve) and/or the channel "pump" once a day for 1 minute after 24 hrs of inactivity.

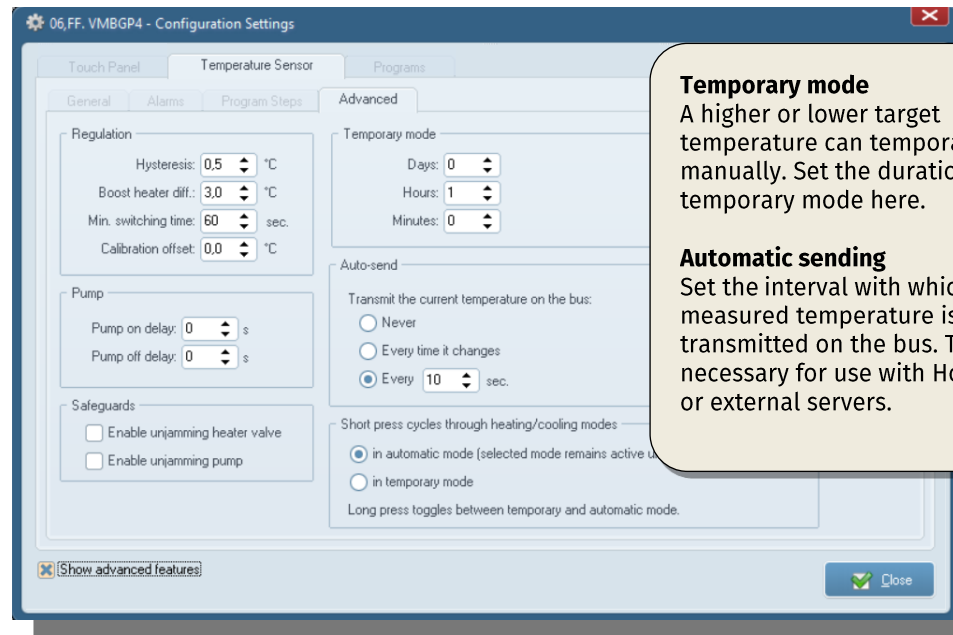

Temporary mode

A higher or lower target temperature can temporarily be set manually. Set the duration of this temporary mode here.

Automatic sending

Set the interval with which the measured temperature is transmitted on the bus. This is only necessary for use with Home Center or external servers.

Please refer to the Velbus Installation Guide for more details on program steps in Velbus.

Program steps

In this tab, program steps can be entered in order to automate the heating and/or cooling. For more details on programs, please consult Part 2: Programming of the Velbus Installation Guide.

Example: push button 1 is assigned to a blind with the action “raise immediately”. By operating push button 1 automatically every day for 0.25 seconds at sunrise, the blind will be raised automatically.

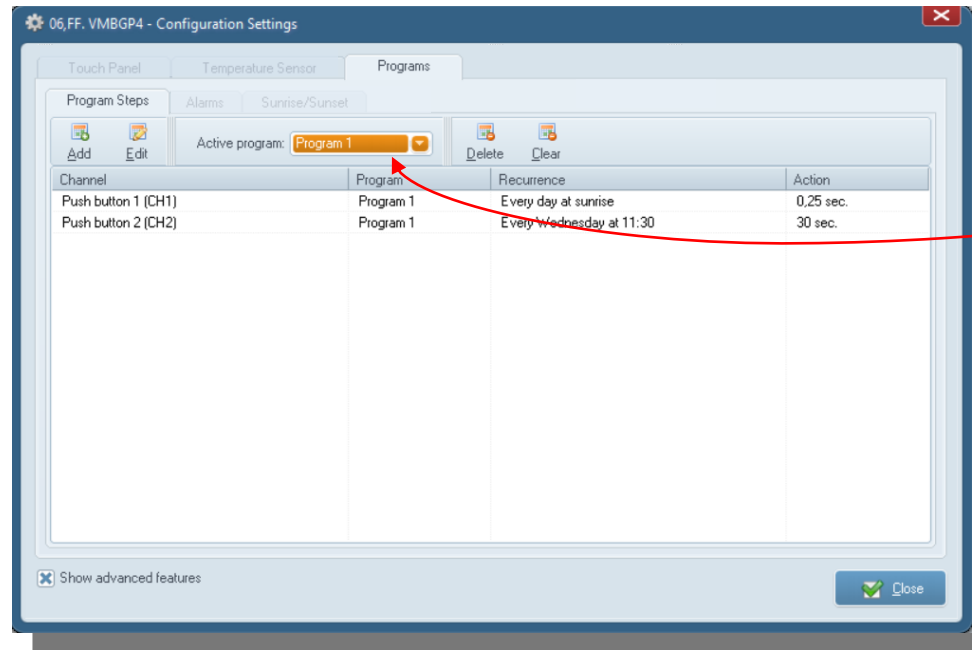

Do not forget to select the active program!



Please refer to the Velbus Installation Guide for more details on program steps in Velbus.

Instead of using specific times in program steps you can also use wake-up and bedtimes. This is an optional and advanced setting and by no means a requirement. For more details please consult Part 2: Programming of the Velbus Installation Guide.

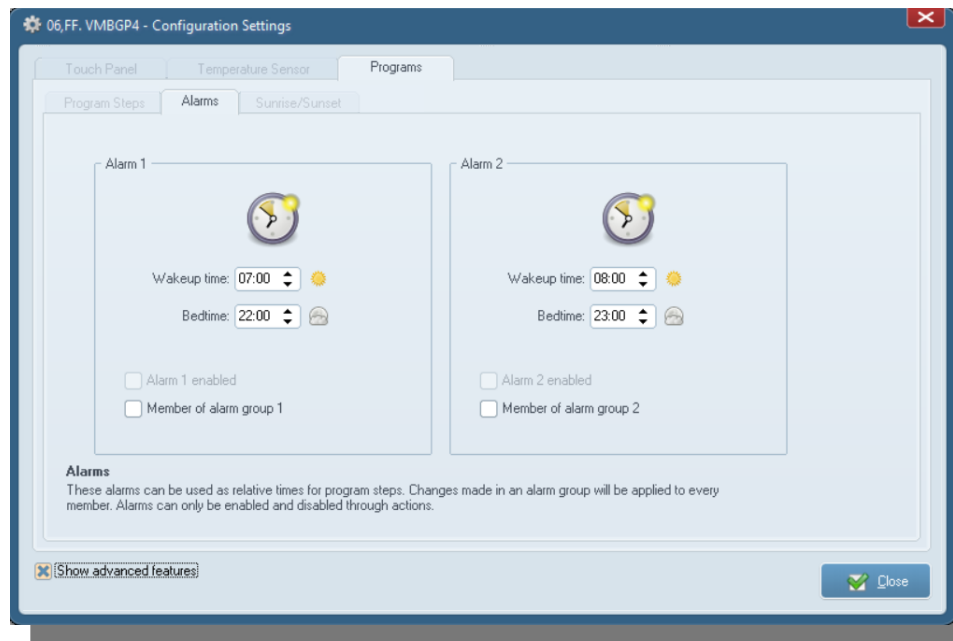

Please refer to the Velbus Installation Guide for more details on program steps in Velbus.

Edit
 Select a date from the list and click on “edit” to change the sunrise and sunset time for that date.
 Attention: the time difference between two consecutive sunrise or sunset times in the table cannot exceed 128 minutes.
E.g. the time difference between the sunrise of 5 January and the sunrise of 21 January cannot be greater than 128 minutes (2 hours and 8 minutes).

Total reset
 Restore the factory settings for the sunrise and sunset times.

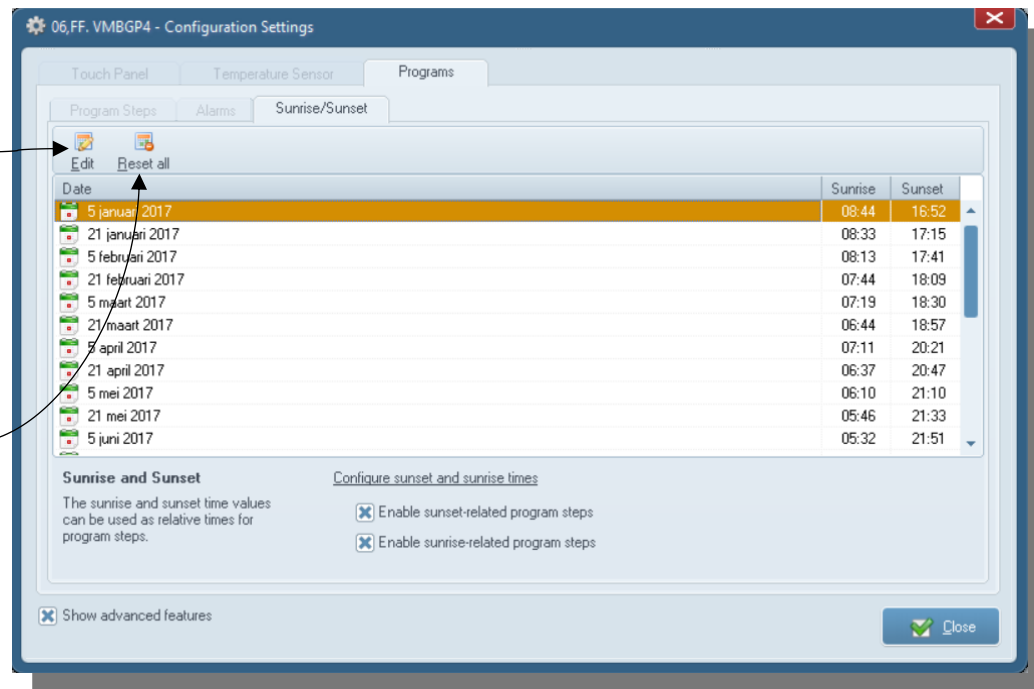

5.2. Configuration of the VMBGPOD:

identical to the VMBGP1/2/4 (see p.12) with the exception of the following tabs

VMBGPOD - Touch screen > General

The VMBGPOD has different pages of 4 push buttons each. Select the pages you wish to edit with the buttons “previous” and “next”, then set the various options.

Set the response time of the buttons here (instantaneous, 1s, 2s, 3s, never).
Example: set the response time to 2s to prevent “everything OFF” being operated by accident. The button will only react when it is held for 2s.

Edit the names of the push buttons here (displayed in Velbuslink). Use the bitmap editor (to the right) to edit how they will be displayed on the OLED screen.

Select the page with push buttons you wish to configure.

Certain actions (e.g. dimming and operating blinds) distinguish between short and long press. The duration of “long press” can be set here (1s or 2s).
 Attention: this setting is independent of the setting “duration long press” in case of double operation.

When memo texts are activated (see Home Center documentation) and this option is checked, the memo text will be displayed when the page is operated. (The top and bottom 4 pixel lines remain available for small icons).

Check the box to make this page available for operation.

Name	Response time
Button 1 Push button 1	Immediately
Button 2 Push button 2	Immediately
Button 3 Push button 3	Immediately
Button 4 Push button 4	Immediately

05,0E,0F,10,A5. VMBGPOD - Configuration Settings

Touch Panel | Temperature | Illumination

General

Long pressed time: 1s

Previous 1/8 Next

Page is visible

Also show memo text

Show advanced features

Close

Open the bitmap editor (see details on next page)

Open an existing .bmp file to be used as bitmap (128 x 32 pixels)

Save the current bitmap in .bmp format

Choose a file to use as an icon. Velbus has an icon library that is opened automatically. If you wish you can also use a different file (15 x 15 pixels, .bmp format).

Clear the selected icon.

Click here to add icons.

Use bold text for all text boxes.

In these fields enter the text to be displayed.

The display returns to the start page after 15 seconds. Select a page as your start page.

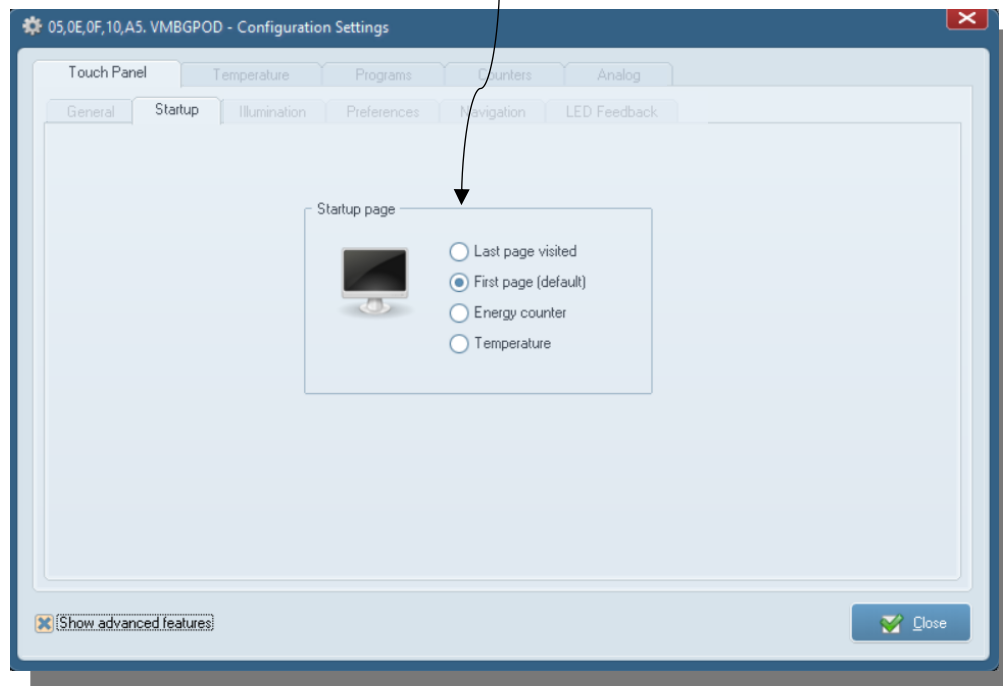

LED backlighting (night indication)
When no feedback is given (about the status of a connected output) the LEDs can either be OFF or glow softly so the push button is easy to locate in the dark. Check those LEDs that will act as night orientation.

Set the intensity of the OLED display (during operation)

Set the intensity of the feedback LEDs.
E.g. a feedback LED is lit when the connected light is ON. Set the brightness with which this feedback will be given.

05_0E_0F_10_A5. VMBGPOD - Configuration Settings

Touch Panel | Temperature | Programs | Counters | Analog

General | Startup | **Illumination** | Preferences | Navigation | LED Feedback

OLED intensity

Chan. 1	Chan. 2
Chan. 4	Chan. 3

Low | High

LED feedback

Intensity: Low | High (default)

LED backlight

Button 1 Button 2

Button 4 Button 3

Enable/disable LED backlight:

Enable all

Previous 1/8 Next

Disable all

Intensity: Low | Medium (default) | High

Show advanced features

Select the pages you wish to set with "previous" and "next"

Set the intensity of the night indication.



Check this box to hear an audible click when the buttons are tapped

The VMBGPOD is equipped with a built-in IR receiver (for use with e.g. the Logitech Harmony) that can be activated here.

Select the menu language here. The menu can be accessed by pressing DOWN (the vertical line under the display) for at least 5 seconds.

A screensaver is activated after 15 seconds of inactivity to prevent screenburn. Choose here whether you want to turn off the display completely or display a dimmed version of the text.

Like all input modules the VMBGPOD has a built-in clock. Check the option "display the clock page" if you want to render it as a separate page on the display.

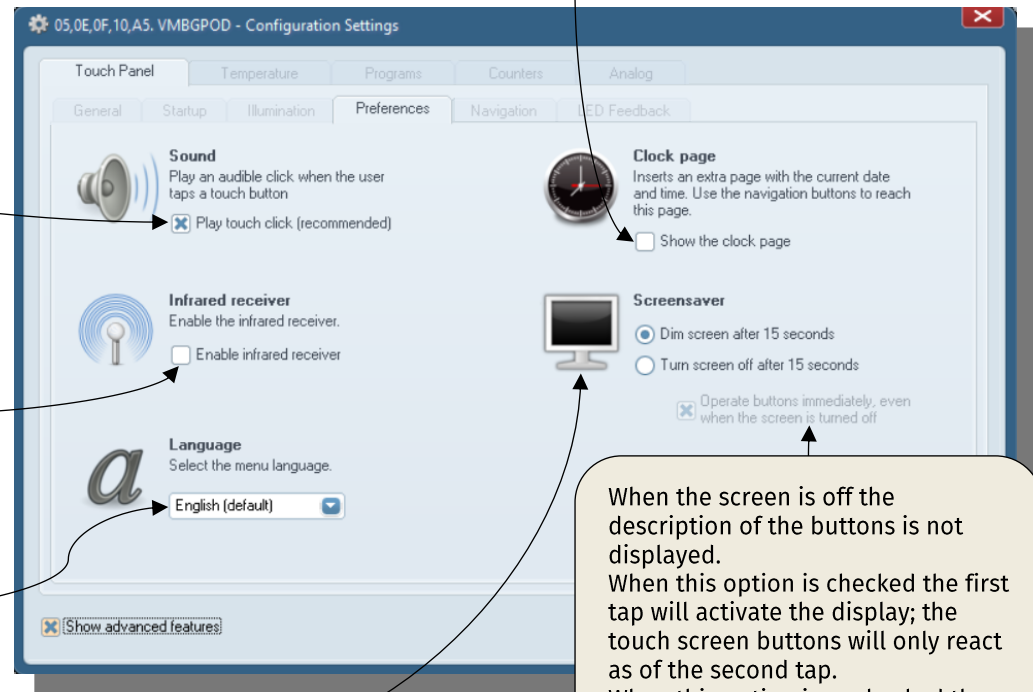

When the screen is off the description of the buttons is not displayed. When this option is checked the first tap will activate the display; the touch screen buttons will only react as of the second tap. When this option is unchecked the touch screen buttons will react instantly, even when the display is turned off.

VMBGPOD - Touch screen > Navigation

When this option is **unchecked**, all active pages are navigated with the LEFT and RIGHT buttons.

When this option is **checked** then the pages are grouped. Press DOWN to navigate from one group to the next. Use LEFT and RIGHT to navigate within a group 'see also p.7).

These are the possible groups:

- push buttons: up to 8 pages of 4 push buttons. To activate multiple pages, multiple addresses must be assigned to the module and the pages must be set to be displayed in the "General" tab (see p. 25)
- thermostats (if activated) Please consult "Part 2: Programming" of the Velbus Installation Guide for a general explanation on the operation of the heating/cooling. See also configuration of the "Temperature" tab (p. 18 and following)
- clock page (if activated in the "Preferences" tab, see p.29)
- counters (if activated in the "Counters" tab, see p.32)

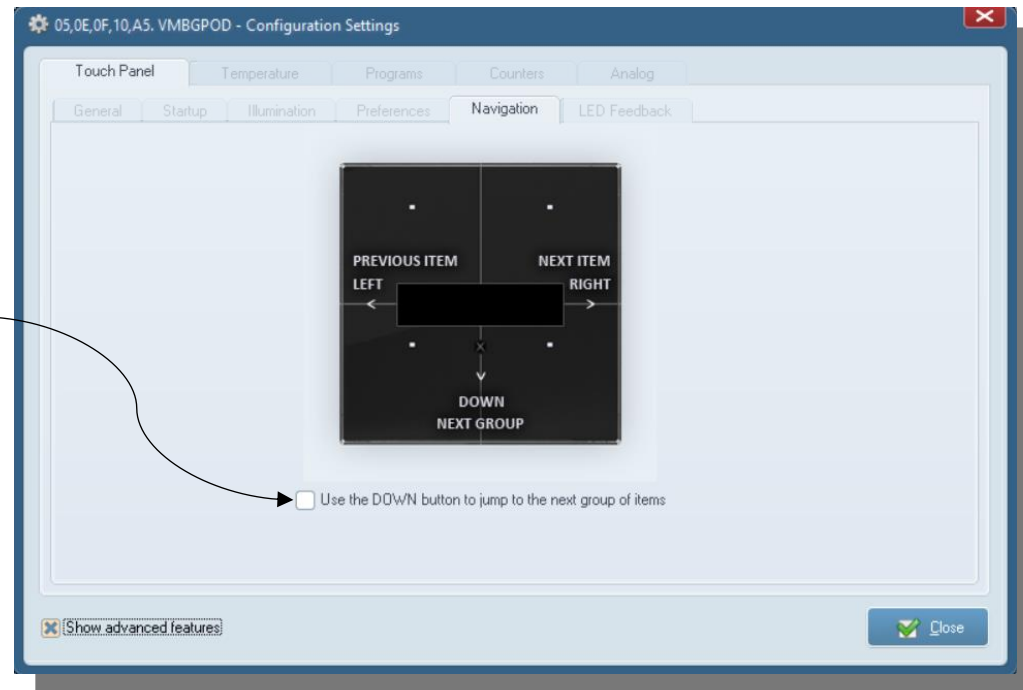
**VMBGP1/VMBGP2/VMBGP4 – Touch screen > LED Feedback**

Analogous with the VMBGP1, VMBGP2 and VMBGP4, see p. 16.

VMBGPOD – Temperature sensor: Analogous with the VMBGP1/2/4 (see p.18) with the exception of the following tab

VMBGPOD - Temperature sensor > External temperature sensors

The temperature settings only apply if the temperature sensor has been assigned an address. For more details on how to control heating and cooling, please refer to the Velbus Installation Guide.

External temperature sensors

The display of the VMBGPOD not only allows operation of its own thermostat but also that of other glass control modules (with or without OLED display, up to 12 modules). External temperature sensors can be connected in this window.

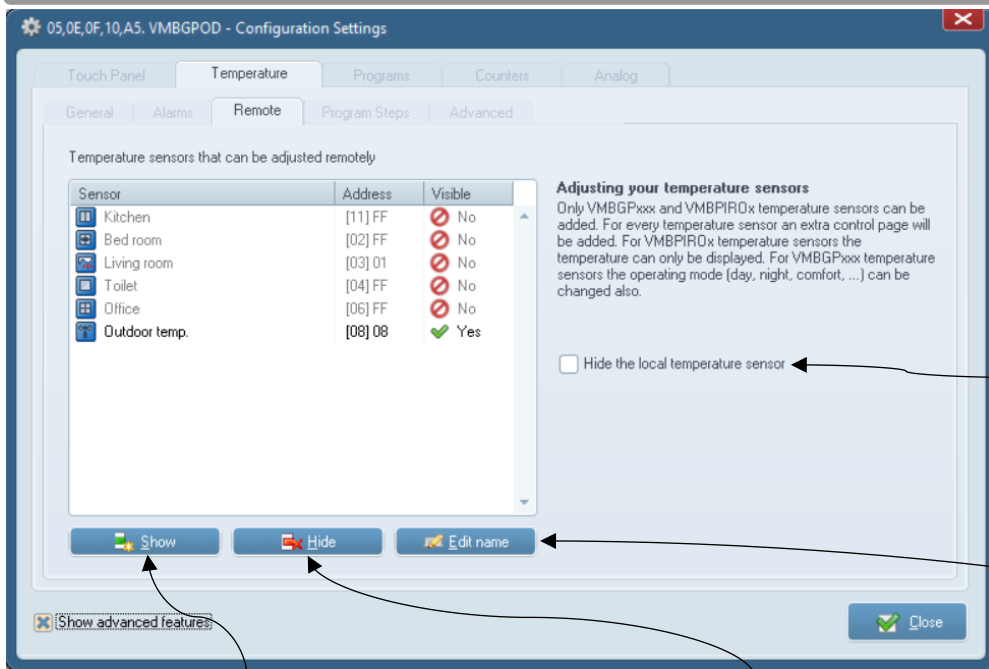

If this option is checked, the external temperature sensors will be accessible on the OLED display but not the sensor of the module itself.

Select an external temperature sensor from the list and click on “display” to connect it.

Select an external temperature sensor from the list and click on “hide” to disconnect it.

Edit the name of the selected temperature sensors (identical to setting the “Sensor name” on the “Temperature” > “General” tab, see p.18)

Counters
Pulse counters can be connected to the VMB71N input module (see documentation of the VMB71N) and they can be added here.
As a result, a new page per counter becomes available on the OLED screen where the measured values (current consumption, day total and total consumption) are displayed.

Open a dialogue window where the counters can be selected. Select the counter you need and press "OK" to add it.

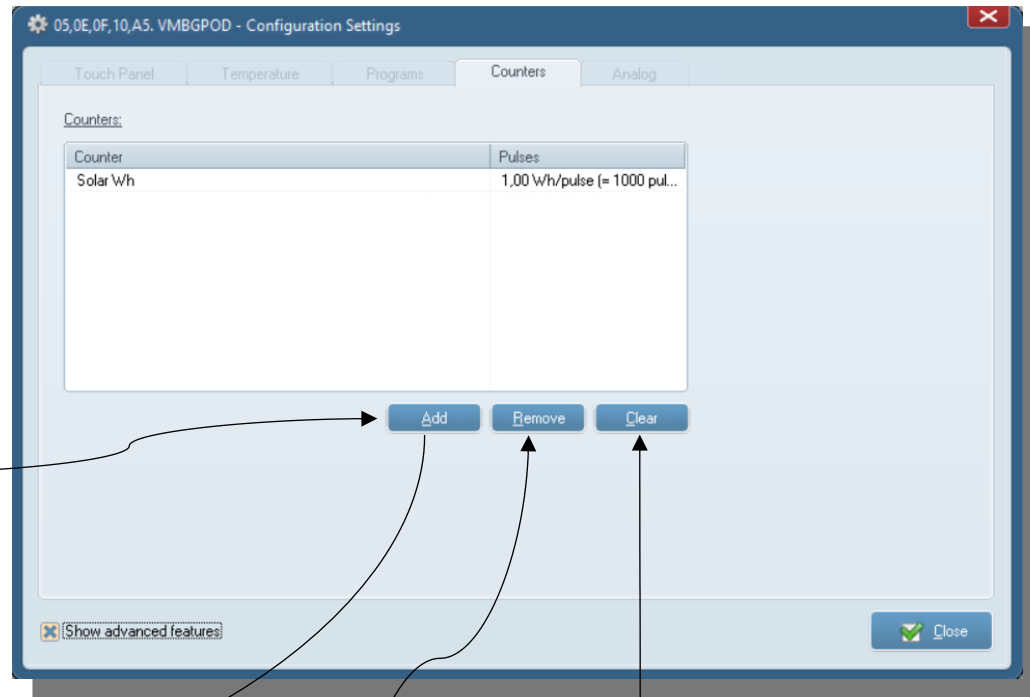
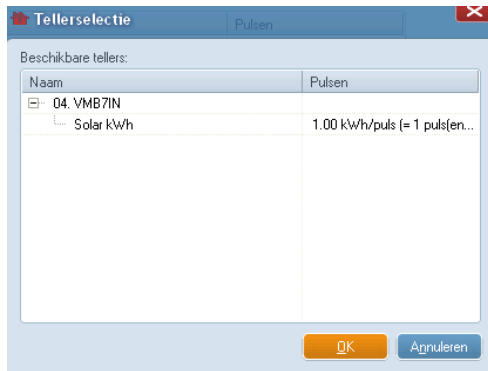

Clear the counter list.

Select a counter from the list and press this button to remove it.

5.3. Configuration of the VMBGP4PIR

Analogous with that of the VMBGP1/2/4 (see p.12) with the exception of the following tabs:

VMBGP4PIR – PIR > Operation

The operation settings are identical to those of the VMBGP1/2/4 modules (see p.13) with the exception of the detail displayed below.

Select this option and the 4 push buttons will act as one large push button

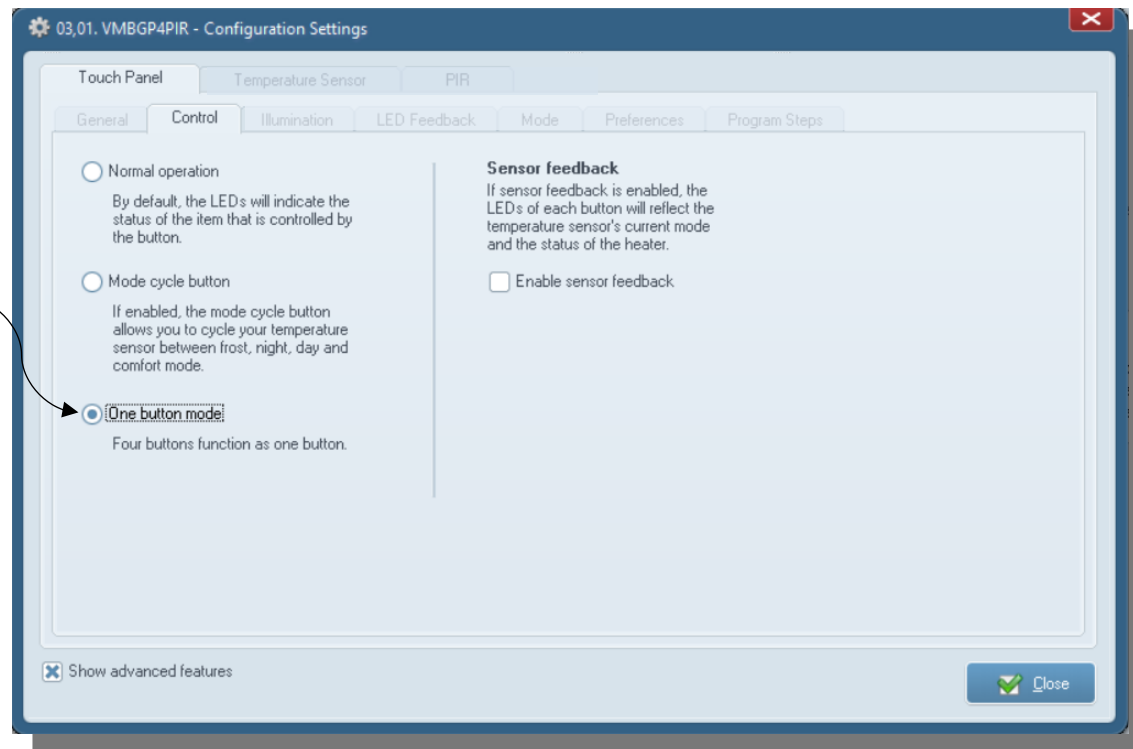

VMGBP4PIR – PIR > Twilight

The PIR settings are identical to those of the VMBPIRM mini PIR sensor, with the exception of the detail displayed below (i.e. the VMGBP4PIR has only one twilight output; the VMBPIRM has two). Please go through the documentation of the VMBPIRM for the common settings.

- on when dark: the channel “dark/light output” closes as soon as it grows darker than the “Dark” limit value. Once closed the channel will not open until it grows lighter than the “Light” limit value (hysteresis).
- on when light: the channel “dark/light output” closes as soon as it grows lighter than the “Light” limit value. Once closed the channel will not open until it grows darker than the “Dark” limit value (hysteresis).

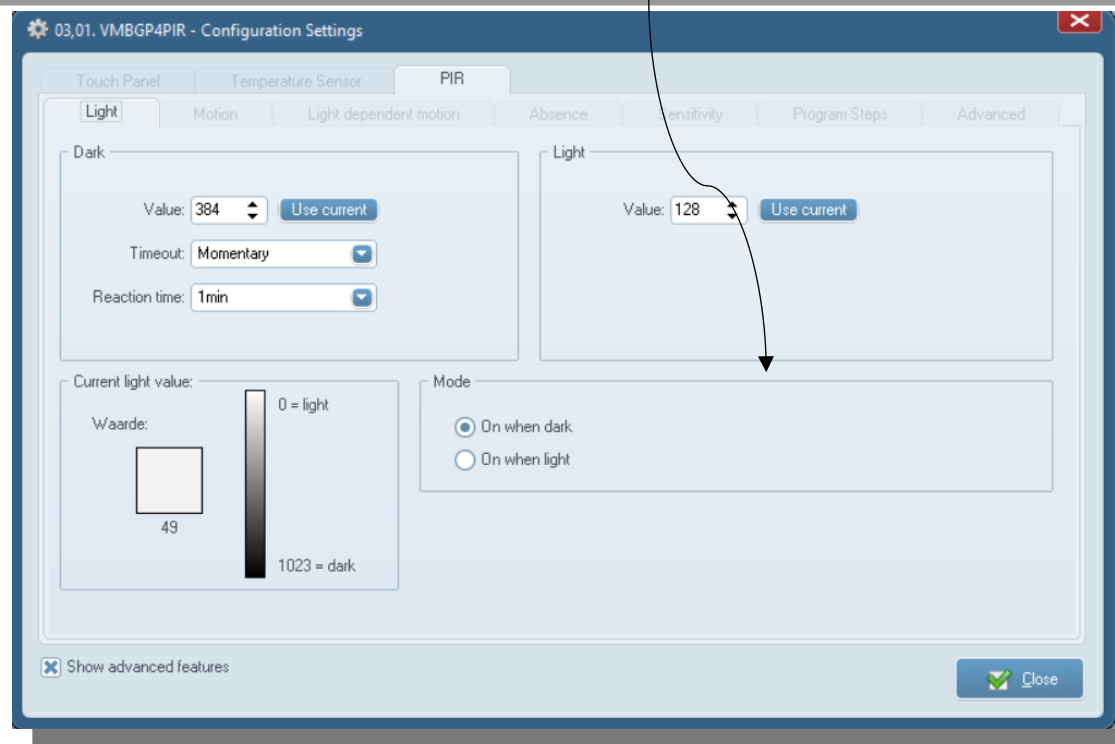

6. Configuration of the VMBGPOD via the OLED screen

The VMBGPOD is normally configured using the Windows program Velbuslink (see p.11 and Part 2: Programmation of the Velbus Installation Guide).

A large portion of the settings can also be accessed via the OLED screen of the VMBGPOD. **Hold the “bottom” button for at least 5s to open the configuration menu.** To return to normal operation, once again hold “bottom” for at least 5s or wait for 15s.

A different configuration menu will open depending on which page is currently activated.

6.1. Configuration of push buttons

The following options become available if “bottom” is held for at least 5s on a page with push buttons:

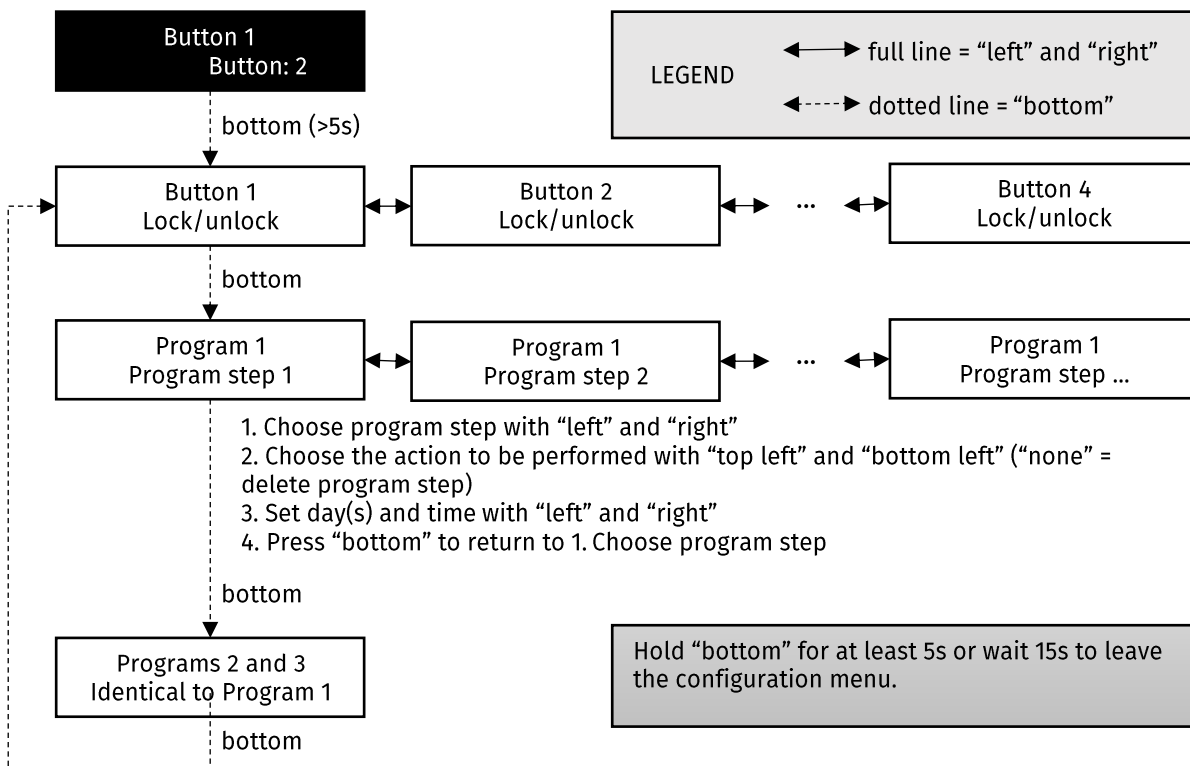

6.2. Configuration of pulse counters

Up to 4 pulse counters (linked to a VMB7IN input module) can be connected with a VMBGPOD so the measured values can be read out on the OLED screen.

When a pulse counter page is displayed, the pulse counter configuration menu can be accessed by holding “bottom” for at least 5s. Then select one of several layouts by pressing “left”, “right” or “bottom”. Wait 15 seconds or once again hold “bottom” for at least 5 seconds to restore normal operation.



6.3. Configuration of thermostats

(see also p. 38 and p.39)

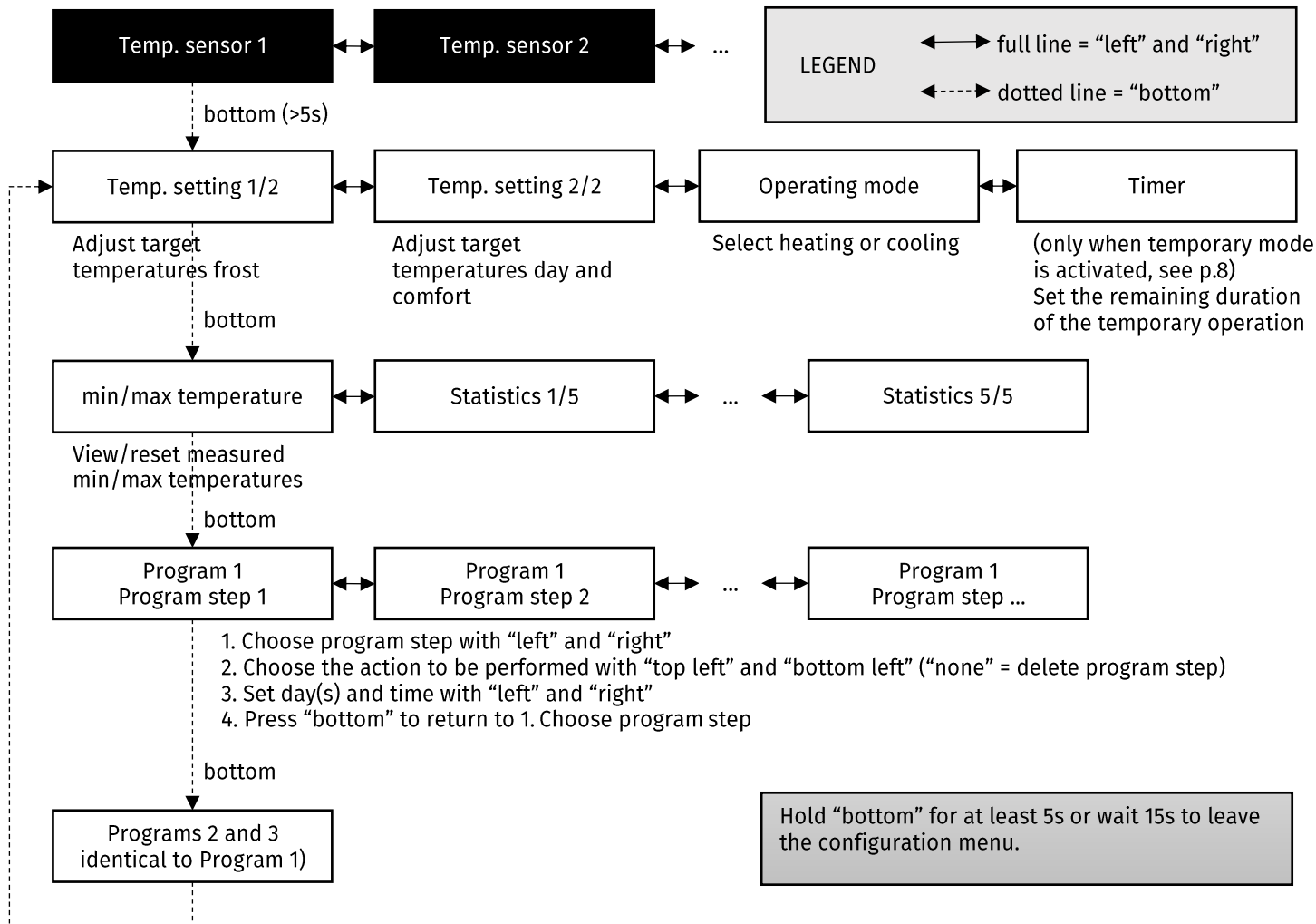



6.4. Clock configuration

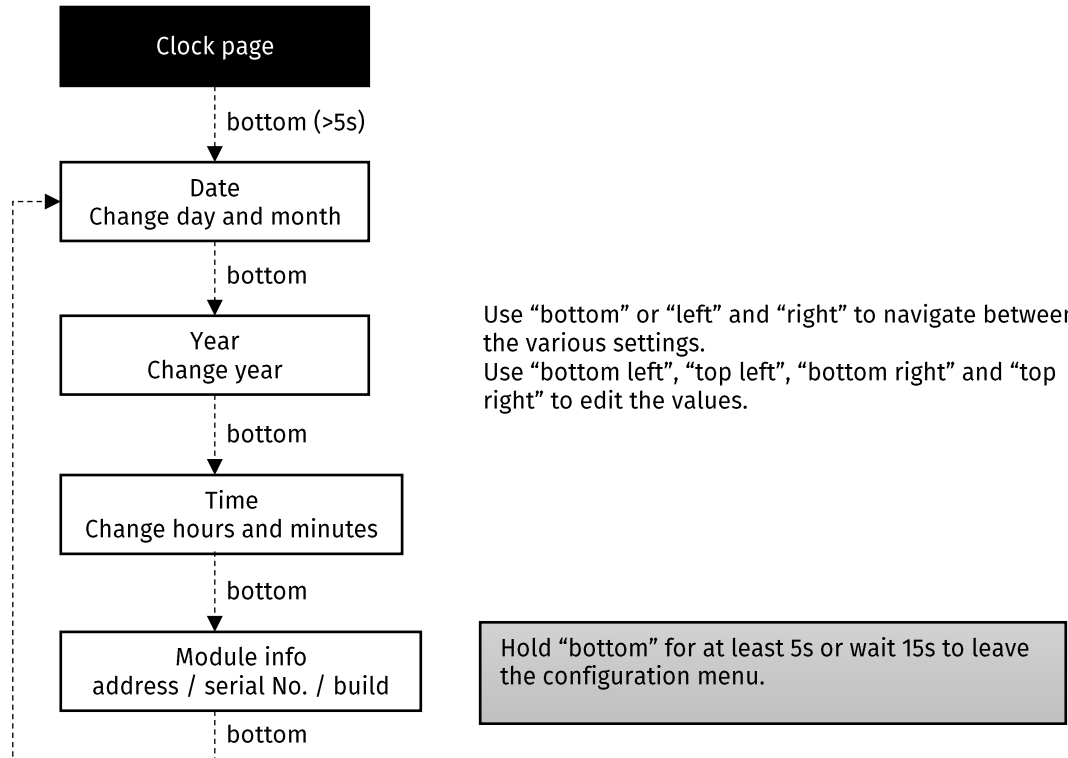

7. Appendix A - VMBGPOD detailed thermostat configuration

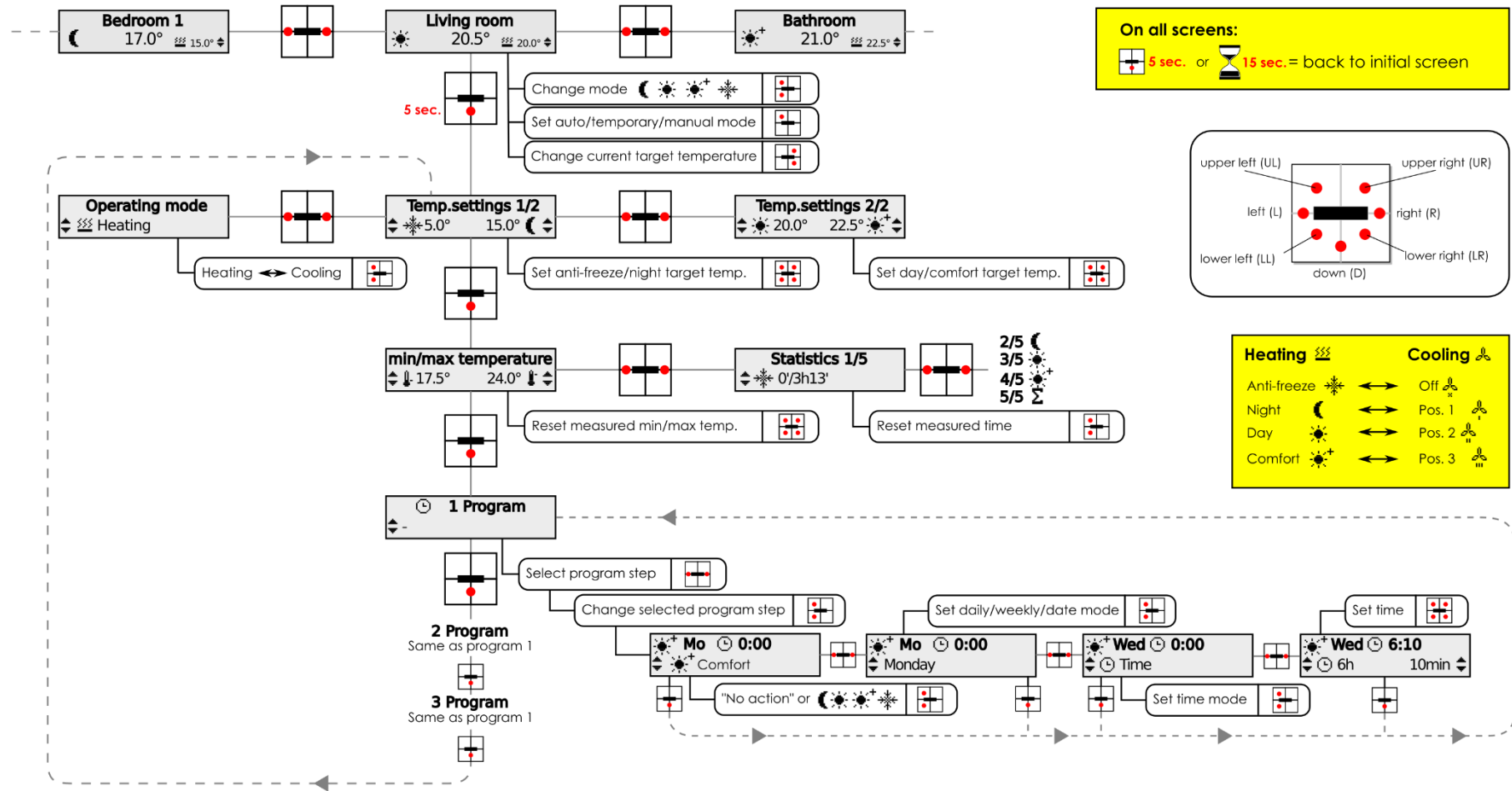

8. Appendix B - VMBGPOD changing a thermostat program step using the oled configuration menu

1. Select the thermostat (L,R)

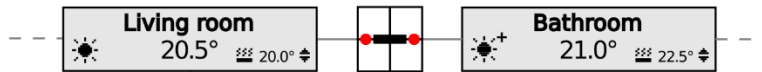

2. Press "UNDER" during 5 seconds



3. Press "UNDER"



4. Press "UNDER" again

5. Select the program step to be modified (L,R)



6. Press UL or LL to modify the selected program step.

7. Use L,R to navigate between options. Make modifications using UL, LL, UR and LR.

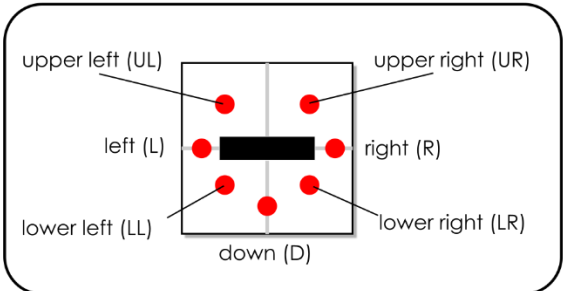
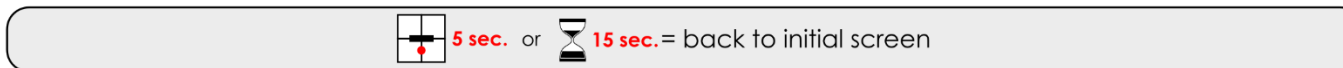
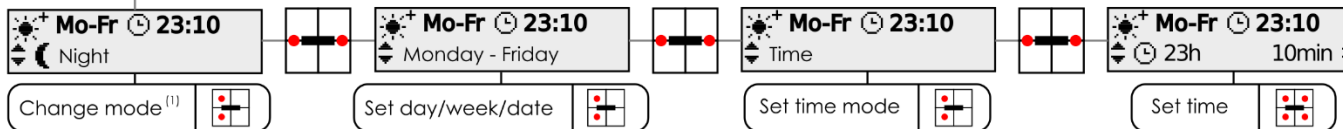

(1) "No action" = delete program step