

DATA SHEET

JUNE 2018

BRIGHTDOT - THE WEARABLE LED COLLECTION

It's time to get creative with LEDs thanks to the BrightDot wearable collection!

This collection includes a series of diverse PCBs with addressable RGB LEDs and a unique development board to create something bright & wearable that's also smart.

Getting any ideas? Here's one: connect the board with any of the BrightDot wearable LEDs and make them react to a text or social message, magnets, sounds, time, temperature and more!

Read on and find out more about the different LED PCBs and the development board's special features.

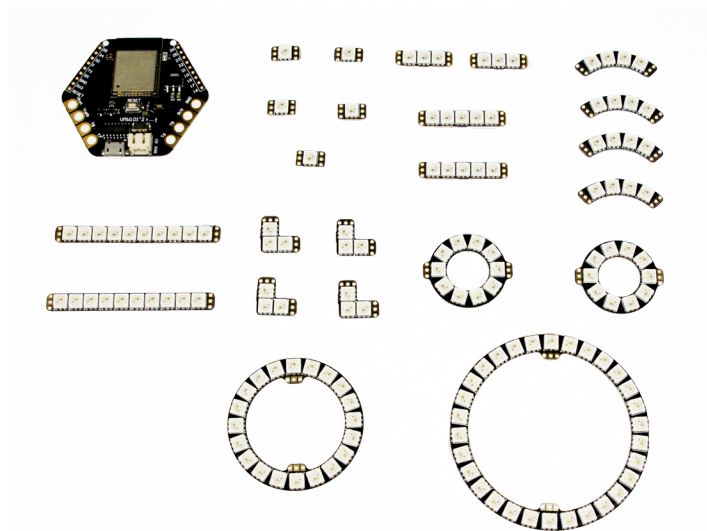

MANUAL AND TUTORIALS ON VELLEMANPROJECTS.MANUALS.EU



● BrightDot rainbow braces that react to sounds



● BrightDot twinkle beanie

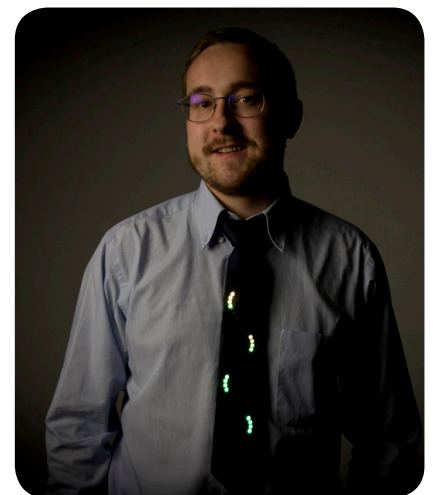

● BrightDot snake tie

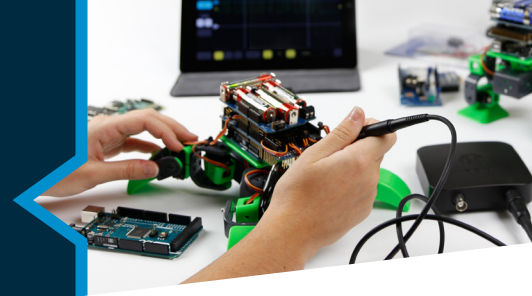

ESP32 WEARABLE DEVELOPMENT BOARD

ORDER CODE: VMW101

FULLY
ARDUINO
COMPATIBLE!

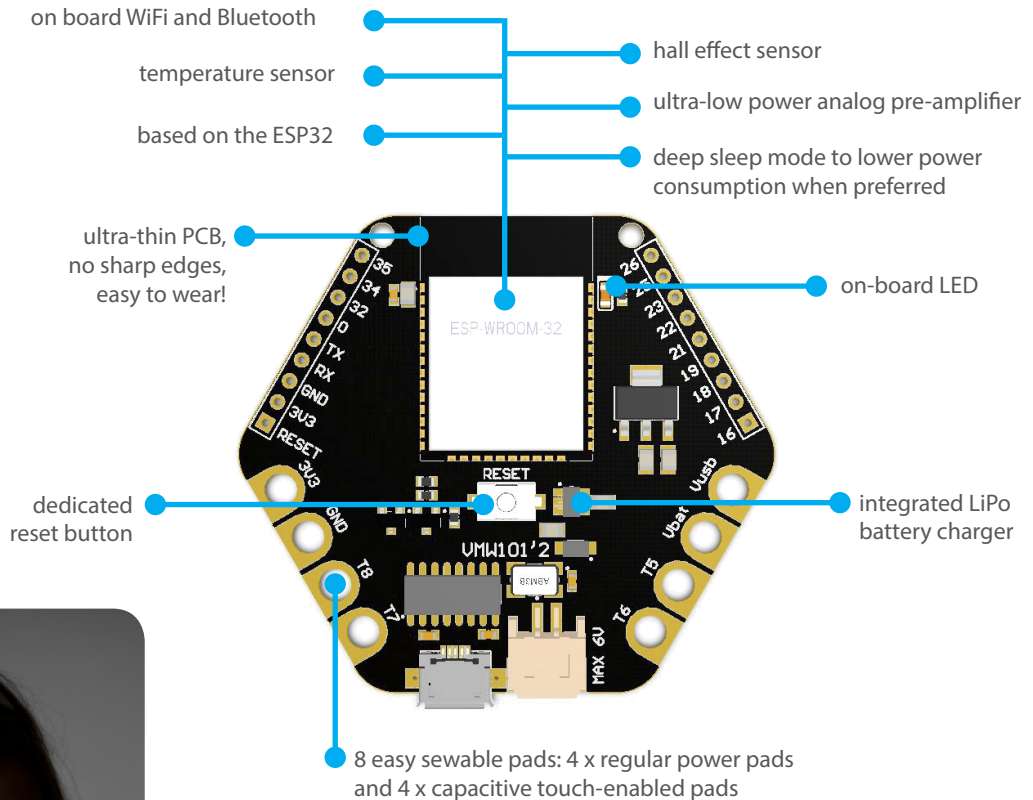

Get ready to meet the most versatile wearable and ESP32 based development board of the moment! It's 100% Arduino compatible and it's easy to wear thanks to its uniquely thin PCB with 8 x sewable pads.

Get creative and connect this ESP32 based development board with the BrightDot LED collection!

MORE FEATURES

- 2 x 8-bit DACs
- compatible with all BrightDot wearable LED boards
- SPI, I²S, I²C and UART interfaces
- the LED PWM, UART, I2C, I2S, and general purpose SPI functions can be configured to any GPIO
- 12-bit SAR ADC
- LED PWM (up to 16 channels)

SPECIFICATIONS

- general purpose IO: 17
- processors:
 - CPU: Xtensa dual-core (or single-core) 32-bit LX6 microprocessor, operating at 160 or 240MHz and performing at up to 600DMIPS
 - ultra low power (ULP) co-processor
- memory:
 - 520KB SRAM
 - 448KB ROM
- wireless connectivity:
 - WiFi: 802.11b/g/n
 - Bluetooth®: v4.2BR/EDR and BLE
- power management:
 - max current consumption : 300mA
 - deep sleep power consumption : 10µA
 - max battery input Voltage: 6V
 - max battery charge current : 450mA
- dimensions: 56 x 50 x 7.5mm (W x L x H)



BRIGHTDOT - WEARABLE LEDS

BrightDots are small and wearable modules with one or more LEDs that need to be controlled by an Arduino compatible development board like the ESP-32 wearable development board.

The entire collection includes a series of diverse modules with addressable RGB LEDs that can be controlled individually. Every LED is controlled by 3 wires (power, ground & data) and can be connected via these wires to the next LED, creating a big string of LEDs. You can solder these LEDs in electric circuits, or sew them into clothing, onto backpacks, onto shoes, ...

TYPES

- singleton BrightDot
- threefold BrightDot strip
- fivefold BrightDot strip
- tenfold BrightDot strip
- left BrightDot corner
- right BrightDot corner
- left BrightDot arc
- right BrightDot arc
- small BrightDot circle
- medium BrightDot circle
- large BrightDot circle

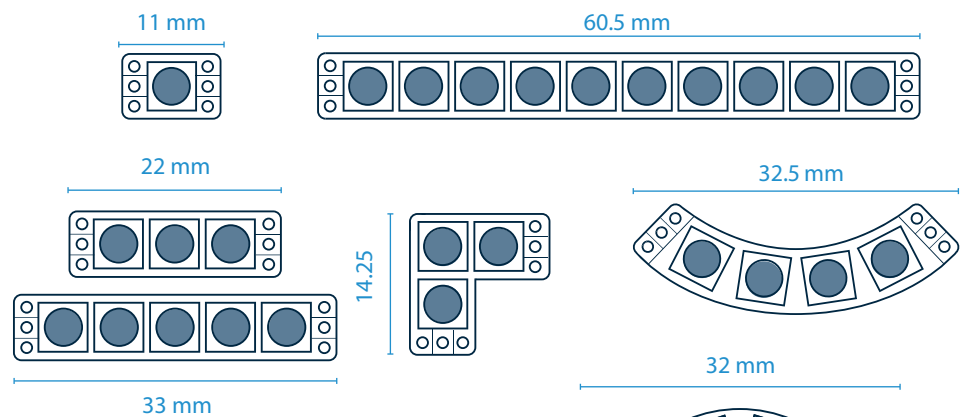

All designs are pictured to scale.

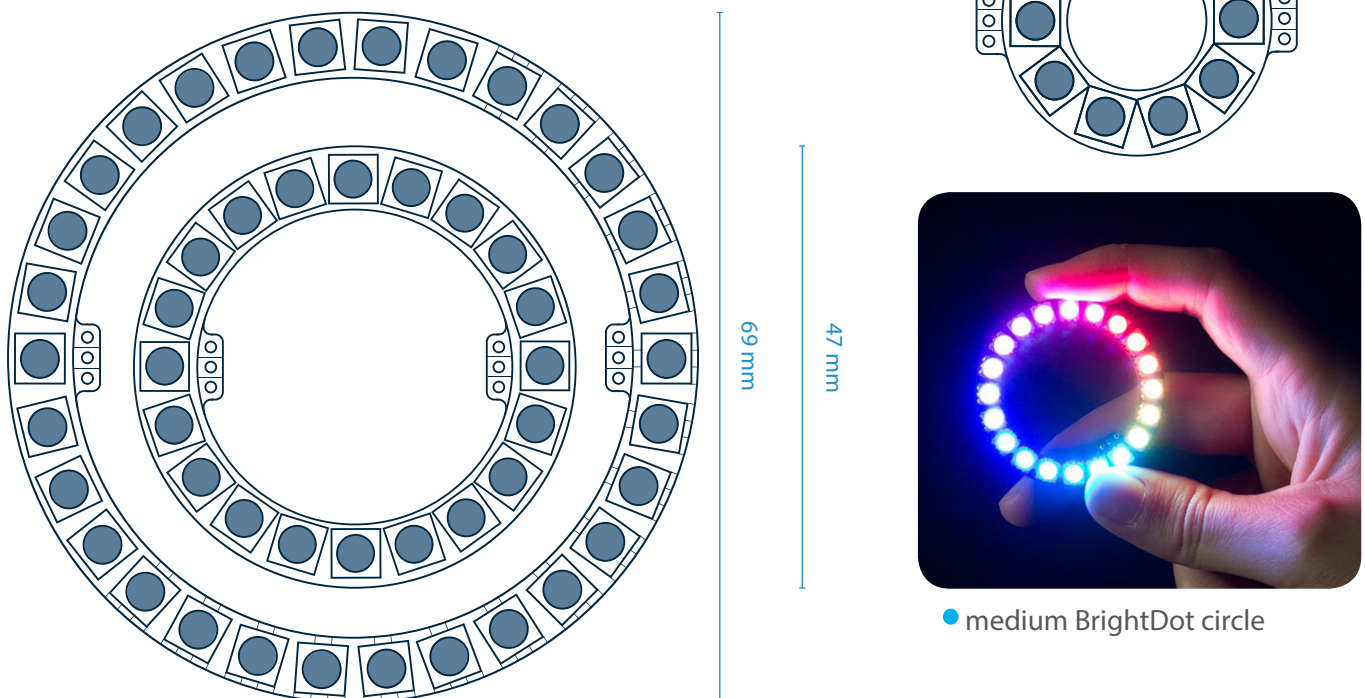

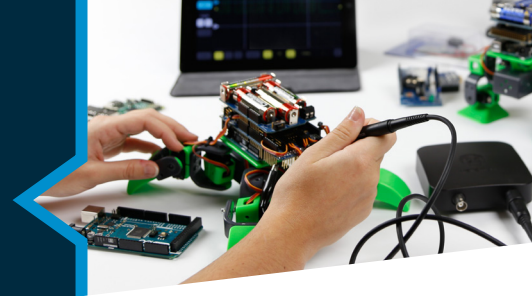

FEATURES

- integrated backup line (this ensure that one broken LED does not affect the next LED)
- each PCB has gold plated contacts with 6 sewing holes of 1,22mm
- solder or sew them!

SPECIFICATIONS

- max. current consumption: 60 mA / LED at full brightness
- power supply: 3.3 V - 5 V
- PCB thickness : 2,1 mm
- needed: ESP32 WEARABLE DEVELOPMENT BOARD or other Arduino compatible development board



CONNECTION EXAMPLE

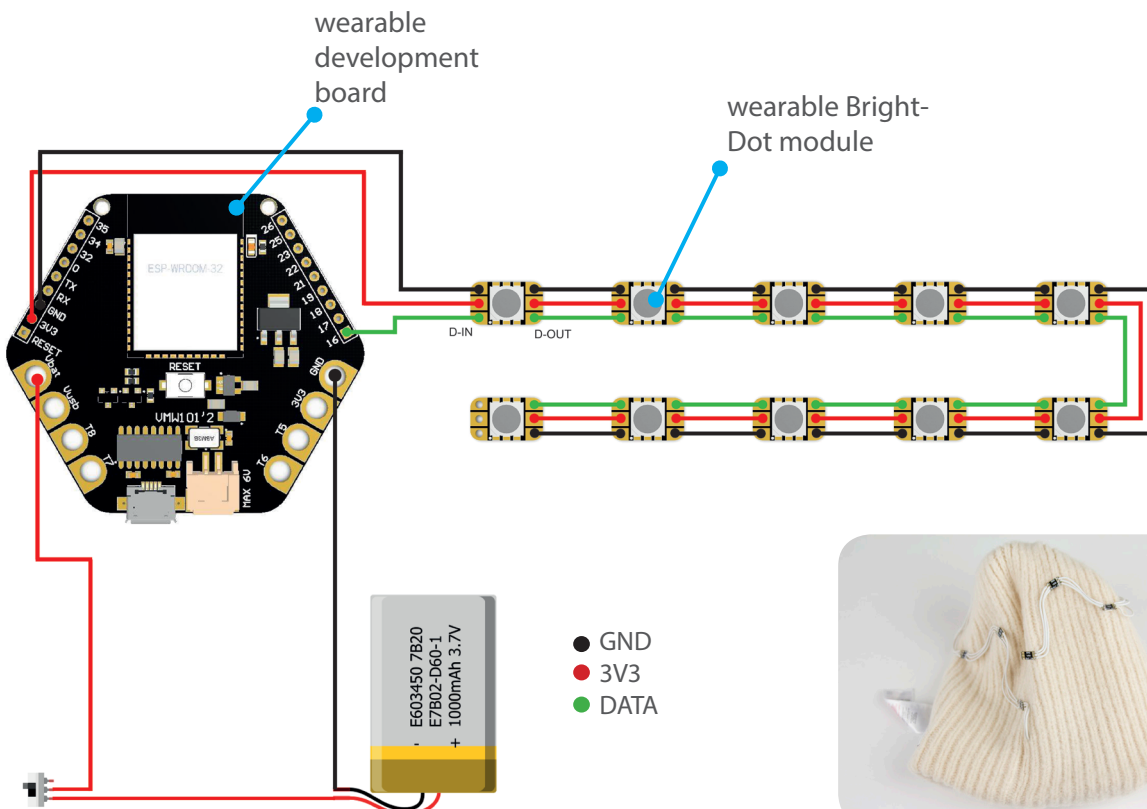

Connection for the Bright-Dot
twinkle beanie

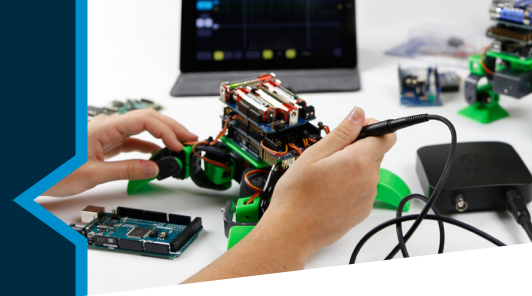

BRIGHTDOT SETS

SMALL BRIGHTDOT PACK (VMW102)

5 x singleton BrightDot

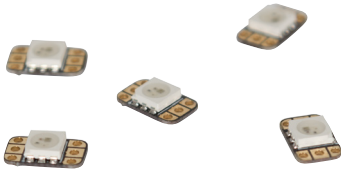

CORNER BRIGHTDOT PACK (VMW105)

2 x left BrightDot corner
2 x right BrightDot corner

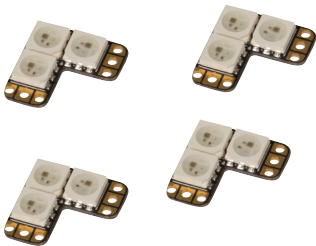

MEDIUM BRIGHTDOT CIRCLE PACK (VMW108)

1 x medium BrightDot



MEDIUM BRIGHTDOT PACK (VMW103)

2 x threefold BrightDot strip
2 x fivefold BrightDot strip

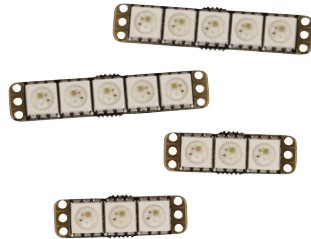

ARC BRIGHTDOT PACK (VMW106)

2 x left BrightDot arc
2 x right BrightDot arc



LARGE BRIGHTDOT CIRCLE PACK (VMW109)

1 x large BrightDot circle



LARGE BRIGHTDOT PACK (VMW104)

2 x tenfold BrightDot



SMALL BRIGHTDOT CIRCLE PACK (VMW107)

2 x small BrightDot

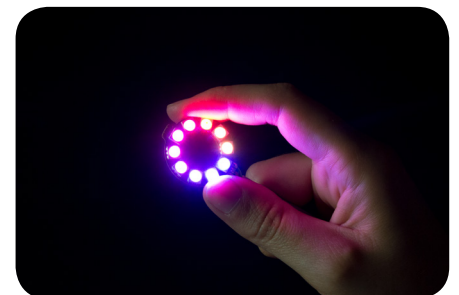

MORE SETS AND ACCESSORIES
COMING SOON!

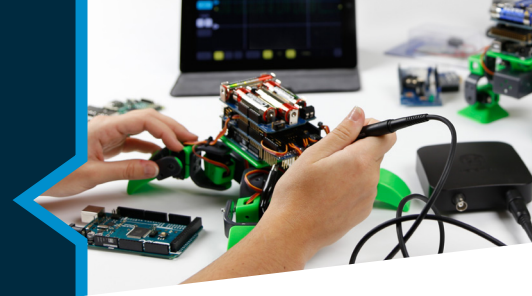

ACCESSORIES

BRIGHTDOT SEWING KIT FOR ELECTRONIC WEARABLES (VMW110)

Are you planning to connect your BrightDots by sewing them? Great! Because this kit includes everything you need to get started; conductive sewing thread, 20 different sewing needles, and thread fixator.

Why choose sewing instead of soldering?

Sewing the BrightDots onto the fabric ensures that your clothing or accessory stays flexible which makes it ideal if you are using thin fabrics for your project. However, sewing is a precise job so make sure that your sewing skills are on point and that you use the thread fixator to keep loose threads from creating a short circuit.

The conductive sewing thread that is included in this set has been selected by our engineers and tested by our community to ensure a good connection and a positive experience while sewing.

Be sure to read all our tips and tricks concerning the BrightDots on manuals.velleman.eu!



FEATURES

- conductive sewing thread (3 ply)
- sewing needle set (20 pcs, 5-9)
- thread fixator (5 ml)

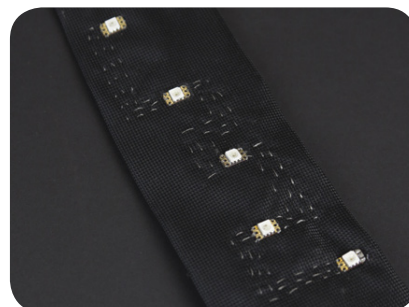

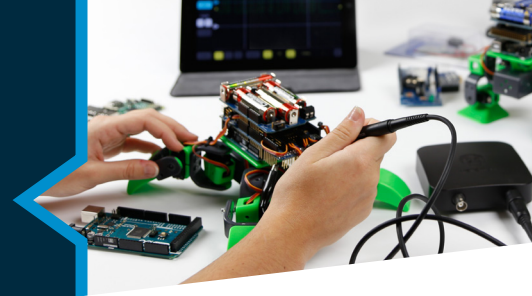

ACCESSORIES

BRIGHTDOT POWER & FUSE PACK (VMW111)

This set is all you need to power up your Brightdot projects or any other electronic circuit in a safe way.

Among other things, the set includes a battery pack for 3 x AA batteries with an onboard on/off switch and a connector wire to connect it to the wearable development board. To give you an idea; this battery pack can power a wearable development board and 10 twinkling BrightDot LEDs (not modules) on full brightness for more than 8 hours!

In order to keep your wearable project safe in case of shorting, you can add the fuse board to the circuit. This board will protect the batteries and thus prevent a fire hazard. Use the included connector cable to connect the fuse board to the development board and you're all set. Remember, you can never be too safe with electronics kids!

Some extra fuses are also included in case you 'fused up' the ones that are already onboard the fuse board. Check out the features and specifications below for more info!

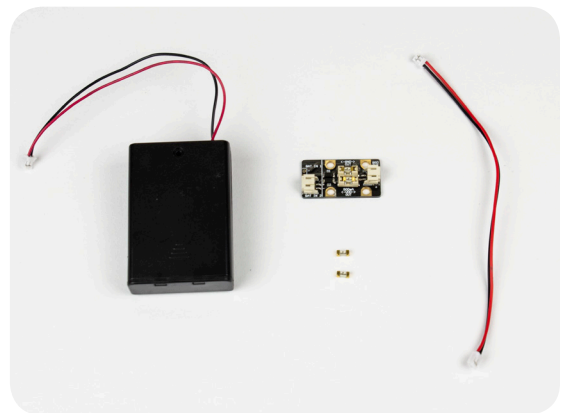

FEATURES

- a fuse board
 - Vin connectors:
 - BAT1: soldering points for your own power connection
 - BAT2: JST Connector for standard LiPo battery and/or our Alkaline battery pack
 - Vout connector: JST
 - fuses:
 - a fuse to protect the LED circuit
 - a fuse to protect the development board
- a battery pack for 3 x AA batteries (batteries not incl.)
- a fuse board to development board cable
- spare fuses (one of each kind)

SPECIFICATIONS

- fuse board dimensions: W38 x L38 x H7,4mm
- fuse trip current LEDs: 500mA
- fuse trip current development board: 750mA
- fuse board max. forward voltage: 360mV

