

## WC201

---



USER MANUAL	2
HANDLEIDING	11
MODE D'EMPLOI	20
MANUAL DEL USUARIO	29
BEDIENUNGSANLEITUNG	38
INSTRUKCJA OBSŁUGI	47
MANUAL DO UTILIZADOR	56



# USER MANUAL

## 1. Introduction

To all residents of the European Union

### Important environmental information about this product



This symbol on the device or the package indicates that disposal of the device after its lifecycle could harm the environment. Do not dispose of the unit (or batteries) as unsorted municipal waste; it should be taken to a specialized company for recycling. This device should be returned to your distributor or to a local recycling service. Respect the local environmental rules.

**If in doubt, contact your local waste disposal authorities.**

Thank you for choosing Perel! Please read the manual thoroughly before bringing this device into service. If the device was damaged in transit, do not install or use it and contact your dealer.

## 2. Description

1. ON/OFF switch
2. PSU

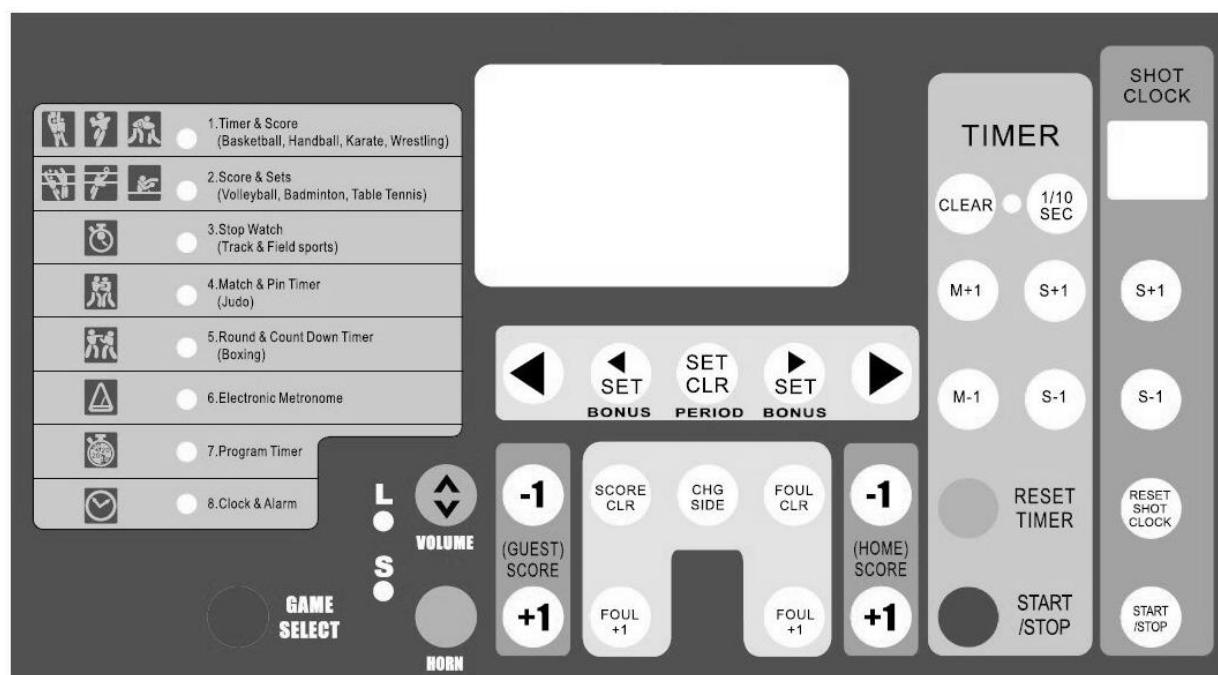
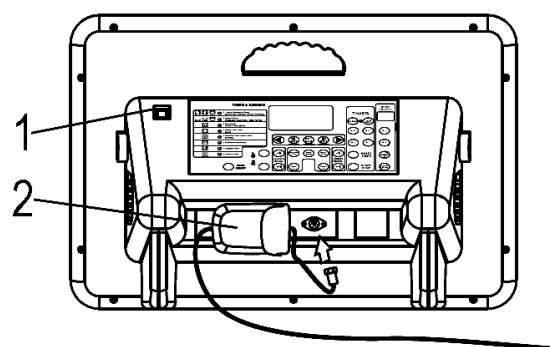

### 3. Setting Up the Scoreboard

- Supply power to the board by connecting the PSU with the power input (see fig. 1). Plug the PSU into the mains.
- Turn on the scoreboard with the ON/OFF switch. It takes a few moments for the board to initialize.
- Press **GAME SELECT** once. The timer & score mode LED blinks.
- Press **CLEAR**. Next, set the desired timer with **M+1/M-1** and **S+1/S-1**, and set the shot clock with **S+1/S-1** under the shot clock panel.
- Press the timer **START/STOP** button to start the timer and the shot clock, and let it run for a few seconds. Press the timer **START/STOP** button again.
- Press **RESET TIMER** and **RESET SHOT CLOCK**. The display will show the last memorized data.
- Press **GAME SELECT** to exit the setup mode.















### 4. Operation

#### A. TIMER & SCORER (basketball, handball, karate, wrestling)

This game mode displays the remaining game time and the score.

Upper display: game time (max. 99:59)

Lower display: score (max. 199)

Countdown Game Timer				
Operation	Key		Display	Buzzer
	Timer	Shot Clock		
1. Select game			0:00 0 0	
2. Recall last memory			20:00 0 0	
3. Erase previous settings			0:00 0 0	
4. Set game time (e.g. 20 min)	 		20:00 0 0	
5. Set shot clock		 	20:00 0 0	
6. Shot clock time is memorized			19:59 0 0	
7. Set period			1234 ••••	
8. Shot hits rim			19:58 0 0	
9. Game interrupted			19:50 0 0	
10. Restart game & shot clock starts			19:49 0 0	
10.1. 30 seconds expire			19:28 0 0	
10.2. Reset to 30 seconds			19:28 0 0	

10.3. Restart game			19:27 0 0	
11. Game time expires			0:00 0 0	
12. Reset game time			20:00 0 0	

- Game timer stopped too late: use and to adjust the difference.
- Press to sound the buzzer.

Score		
Operation	Key	Display
1. <b>Guest</b> team scores		19:20 0 1
2. <b>Home</b> team scores		19:15 1 1
3. <b>Home</b> team loses point or erroneous point adding		19:15 0 1
4. Reset scores		19:15 0 0

Foul		
Operation	Key	Display
1. <b>Guest</b> team commits foul		19:20 0 1
2. <b>Home</b> commits foul		19:15 1 1
3. <b>Home</b> commits second foul		19:15 2 1
4. Reset		19:15 0 0

- Press or to toggle between the home team and the guest team. Press or for bonus points.

Count-up Game Timer				
Operation	Key		Display	Buzzer
	Timer	Shot Clock		
1. Select game			20:00 0 0	
2. Erase previous settings			0:00 0 0	
3. Set display to chrono mode			0:00 0 0	
4. Set game time (e.g. 20 min)			20:00 0 0	
5. Recall shot clock memory			20:00 0 0	

6. Game time returns to 0:00			0:00 0 0	
7. Start game & shot clock simultaneously			0:01 0 0	
8. Game interrupted			0:09 0 0	
9. Reset shot clock			0:09 0 0	
10. Restart game			0:10 0 0	
11. Stop shot clock			0:19 0 0	
12. Game time expires			20:00 0 0	
13. Reset game time			0:00 0 0	

- Game timer stopped too late: use and to adjust the difference.
- Press and then to return to the countdown timer.

**B. SCORE & SETS** (volleyball, badminton, table tennis)

This game mode displays the sets won and the score.

Upper display: score (max. 99)

Lower display: sets (max. 199)





Score / Sets / Serve		
Operation	Key	Display
1. Select game		0 0 0 0
2. Home / guest team gets serve		• 0 0 0 0
3. <b>Home</b> team scores		1 0 0 0
4. <b>Guest</b> team scores		1 1 0 0
5. <b>Guest</b> team wins set		1 1 0 1
6. Change courts		1 1 1 0
7. Reset scores		0 0 0 0



- Press to deduct a point.
- Press and add the exact sets in case of error.

**C. STOPWATCH**

Upper display: minutes and seconds (max. 59:59)

Lower display: hours (max. 199) and 1/100 second (max. 99)

Stopwatch		
Operation	Key	Display
1. Select mode		<b>0:00</b> <b>00</b>
2. Start stopwatch		<b>0:00</b> <b>01</b>
3. Stop stopwatch		<b>15:24</b> <b>2 93</b>
4. Reset stopwatch		<b>0:00</b> <b>00</b>













- Press  while the stopwatch is running to stop the time on the display. The stopwatch is keeps running internally. UP will blink on the display. Press  to continue.

**D. MATCH & PIN TIMER (judo)**

This game mode displays the match time and elapsed pinning time.

Upper display: match time (max. 99:59)

Lower display: pinning time (max. 30)

Operation	Key		Display
	Timer	Shot Clock	
1. Select mode			<b>5:00</b> <b>30</b>
2. Set match time (e.g. 5 min)	 		<b>5:00</b> <b>30</b>
3. Save pin time into memory			<b>5:00</b> <b>0</b>
4. Reset pin time if necessary		 	
5. Start match			<b>5:00</b> <b>1</b>
6. If pin does not begin, pause pin time and reset		 + 	<b>4:53</b> <b>0</b>
7. Pin begins			<b>4:53</b> <b>1</b>
8. Stop match during pinning, pause pin timer			<b>4:35</b> <b>12</b>
9. Restart match, resume pin timer			<b>4:34</b> <b>13</b>
10. Pin broken free			<b>4:25</b> <b>22</b>

↓	10.1. Next pin begins			<b>1:31</b> <b>1</b>
	10.2. 30 seconds have elapsed, match time automatically stops, buzzer sounds			<b>1:00</b> <b>30</b>

11. Match time expires, buzzer will not sound if pin is in progress				<b>0:00</b> <b>22</b>
12. Reset match time		RESET TIMER		<b>5:00</b> <b>0</b>

- Match timer stopped too late: use and to adjust the difference.
- Pinned judoka already has waza-ari (becomes ippon after 25 seconds): press during pin countdown. 25 will appear on the lower left display and the buzzer will sound after those 25 seconds have elapsed. Press again to cancel the 25-second display.
- Match time reaches 0:00 during a pin: the match will continue without buzzer so the pin count will not be interrupted. When the pin is broken free, press . The buzzer will sound and the match will end.







**E. ROUND & BREAK COUNTDOWN TIMER** (boxing)





This game mode displays the round time and number.





Upper display: round timer (max. 99:59)

Lower display: round number (max. 99)

Round & Break Countdown Timer				
Operation	Key		Display	Buzzer
	Timer	Shot Clock		
1. Select game			<b>0:00</b> <b>0</b>	
2. Set round time (e.g. 3 min)			<b>3:00</b> <b>0</b>	
3. Enter round time into memory			<b>0:00</b> <b>0</b>	
4. Set break time (e.g. 1 min)			<b>1:00</b> <b>0</b>	
5. Enter break time into memory			<b>0:00</b> <b>0</b>	
6. Set number of rounds (e.g. 3 rounds)			<b>0:00</b> <b>3</b>	
7. Return to round time display			<b>3:00</b> <b>1</b>	
8. Start match			<b>2:59</b> <b>1</b>	
9. Interrupt match			<b>2:35</b> <b>1</b>	
10. Restart match			<b>2:34</b> <b>1</b>	
11. Knockdown			<b>1:34</b> <b>1</b>	
12. Match continues			<b>1:28</b> <b>1</b>	









	12.1. Knockdown			<b>1:20</b> <b>1</b>	
	12.2. 10 seconds expire, stop countdown and round timer			<b>1:10</b> <b>1</b>	
	12.3. Match over, sound buzzer			<b>1:10</b> <b>1</b>	

13. First round completed				<b>0:00</b> <b>1</b>	
14. Break time				<b>0:59</b> <b>1</b>	
15. Break time ends				<b>0:00</b> <b>1</b>	
16. Next round time and number are displayed				<b>3:00</b> <b>2</b>	
17. Designated number of rounds completed				<b>0:00</b> <b>3</b>	
18. Begin new match		RESET TIMER		<b>3:00</b> <b>1</b>	

- Match timer stopped too late: use  and  to adjust the difference; use shot clock  to adjust the round difference.
- Round time reaches 0:00 during countdown: the match will continue without sounding the buzzer so the countdown will not be interrupted.
- Modifying round/break times: press  and reset.
- In the final round, the break time will not display.

**F. ELECTRONIC METRONOME**

Upper display: rhythm  
 Lower left display: number of buzzes per minute  
 Lower right display: length of a buzz

Electronic Metronome			
Operation	Key	Display	Buzzer
Set buzz length	 	<b>0</b> <b>120 6</b>	
Set buzz number	 	<b>0</b> <b>113 6</b>	
Start metronome		<b>1</b> <b>113 6</b>	
Stop metronome		<b>5</b> <b>113 6</b>	
Reset metronome		<b>0</b> <b>113 6</b>	























**G. PROGRAM TIMER** (interval training)

The timer may be programmed to consecutively count down and display max. 9 time periods.

Upper display: timer (max. 99:59)

Lower left display: number of repetitions (max. 9)

Lower right display: program number (max. 9)

Program Timer			
Operation	Key	Display	Buzzer
1. Set desired time for program 1 (P1)		<b>5:00</b> 1 P1	
2. Enter P1 into memory and enter times for following programs if desired		<b>0:00</b> 1 P2	
3. Complete program setting. Set the desired number of repetitions using the shot clock  . Press  and  . The current round is displayed and the timer will stop.		<b>5:00</b> 1 P1	
4. P1 will start counting down and buzzer will sound when it reaches 0:00. P2 will subsequently start. Completion of all programs is considered one round.		<b>4:59</b>	
		1 P1	
		<b>0:00</b>	
		1 P2	
		<b>3:00</b>	
		1 P3	
		<b>0:00</b>	
		1 P4	
		<b>5:00</b>	
		1 P5	
		.	
		.	
		.	
		<b>4:59</b>	
		2 P1	
5. Stop		<b>2:28</b> 9 P1	
7. Return to the beginning of the program		<b>5:00</b> 0 P1	

- Change set times: Press  and reset timers.







**H. CLOCK & ALARM**

This scoreboard displays the time in 12h format but displays the time in 24h format when editing.

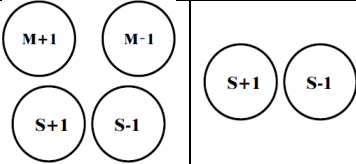
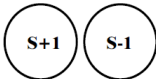
Upper display: hours and minutes

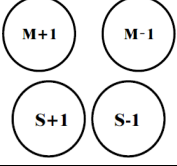

Lower right display: seconds

Clock & Alarm			
Operation	Key		Display
	Timer	Shot Clock	
1. Stop clock to adjust time			<b>0:00</b> 00

2. Set hour, use the timer buttons to adjust the hour and minutes, use the shot clock buttons to adjust the seconds			<b>14:49</b> <b>13</b>
3. Confirm time			<b>2:49</b> <b>13</b>
4. Alarm mode			<b>12:00</b> <b>AL of</b>
5. Alarm on/off			<b>12:00</b> <b>AL on</b>
6. Set alarm time			<b>13:41</b> <b>AL on</b>
7. Return the time display			<b>2:51</b> <b>25</b>

- The scoreboard will buzz during 5 seconds when the time reaches the alarm time.
- Current time and alarm time will not be memorized in case of a power cut.

**I. OTHER FUCNTIONS**

- Press  to sound the buzzer at any time.
- Adjust the volume of the buzzer with .
- Press  (when LED is lit) to display the final minute in seconds.

**5. Technical Specifications**

power supply ..... 100-240 V~, 12 VDC - 3 A  
 power consumption ..... < 25 W  
 max. viewing distance ..... 50 m  
 time accuracy ..... < 0.5 s per day  
 dimensions ..... 620 x 405 x 275 mm  
 weight ..... 4.75 kg

**Use this device with original accessories only. Velleman nv cannot be held responsible in the event of damage or injury resulting from (incorrect) use of this device. For more info concerning this product and the latest version of this manual, please visit our website [www.velleman.eu](http://www.velleman.eu). The information in this manual is subject to change without prior notice.**

**© COPYRIGHT NOTICE**

**The copyright to this manual is owned by Velleman nv. All worldwide rights reserved.** No part of this manual may be copied, reproduced, translated or reduced to any electronic medium or otherwise without the prior written consent of the copyright holder.

# HANDLEIDING

## 1. Inleiding

**Aan alle ingezetenen van de Europese Unie**

**Belangrijke milieu-informatie betreffende dit product**



Dit symbool op het toestel of de verpakking geeft aan dat, als het na zijn levenscyclus wordt weggeworpen, dit toestel schade kan toebrengen aan het milieu. Gooi dit toestel (en eventuele batterijen) niet bij het gewone huishoudelijke afval; het moet bij een gespecialiseerd bedrijf terechtkomen voor recyclage. U moet dit toestel naar uw verdeler of naar een lokaal recyclagepunt brengen. Respecteer de plaatselijke milieuwetgeving.

**Hebt u vragen, contacteer dan de plaatselijke autoriteiten inzake verwijdering.**

Dank u voor uw aankoop! Lees deze handleiding grondig voor u het toestel in gebruik neemt. Werd het toestel beschadigd tijdens het transport, installeer het dan niet en raadpleeg uw dealer.

## 2. Omschrijving

1. aan-uitschakelaar
2. voedingsadapter

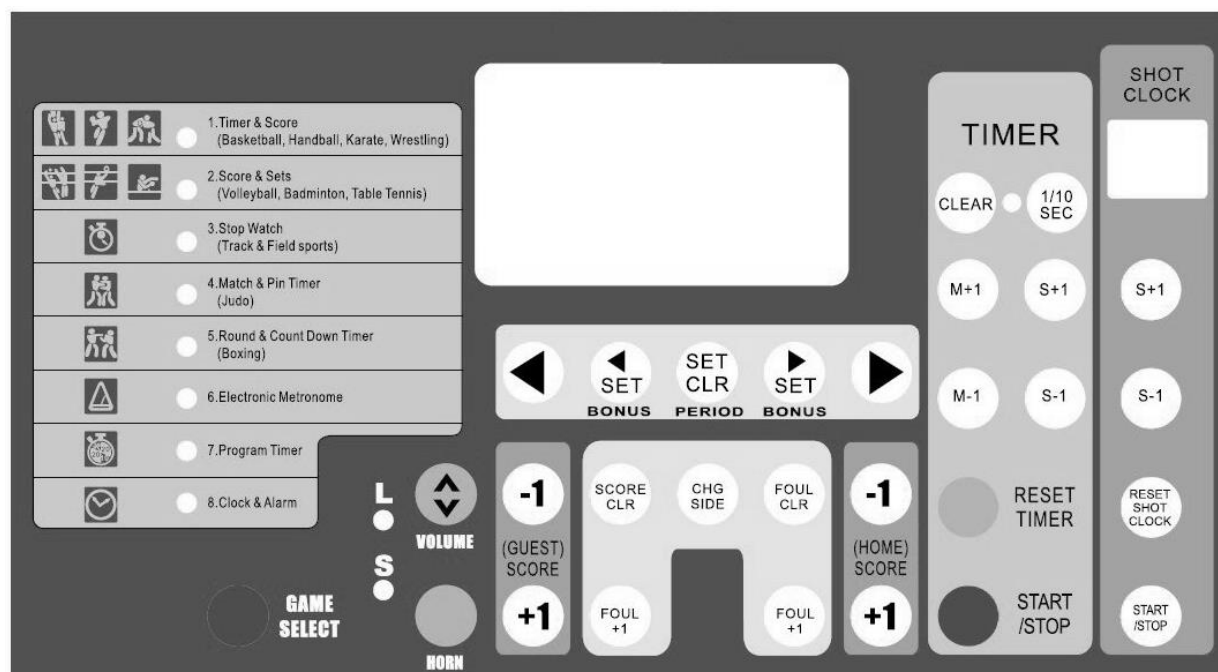
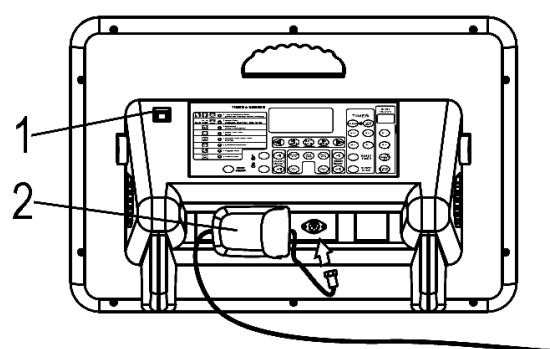

### 3. Het scoreboard opstellen

- Voed het scorebord door de voedingsadapter aan de voedingsingang te sluiten (zie fig. 1). Koppel de voedingsadapter aan het lichtnet.
- Schakel het scorebord in of uit via de aan-uitschakelaar. Na enkele seconden is het scoreboard geïnitieerd.
- Druk eenmaal op **GAME SELECT**. De led naast timer & score knippert.
- Druk op **CLEAR**. Stel vervolgens de timer in met **M+1/M-1** en **S+1/S-1**, en stel de balbezittimer in met **S+1/S-1** in het shotclockmenu.
- Druk op **START/STOP** in het timermenu om de timer en de balbezittimer te starten en laat beide enkele seconden lopen. Druk opnieuw op **START/STOP** in het timermenu.
- Druk op **RESET TIMER** en **RESET SHOT CLOCK**. Het scoreboard geeft de laatst opgeslagen weergave weer.
- Druk op **GAME SELECT** om het instelmenu te verlaten.















### 4. Gebruik





#### A. TIMER & SCORE (basketbal, handbal, karate, worstelen)



Deze modus geeft de resterende tijd en de score weer.





Bovenste rij: speelduur (max. 99:59)





Onderste rij: score (max. 199)





Afteltimer				
Omschrijving	Toets		Display	Hoorn
	Timer	Shot Clock		
1. Selecteer spelmodus			<b>0:00</b> <b>0 0</b>	
2. Roep de laatste instellingen op			<b>20:00</b> <b>0 0</b>	
3. Wis vorige instellingen			<b>0:00</b> <b>0 0</b>	
4. Stel de tijd in (bv. 20 min.)	 		<b>20:00</b> <b>0 0</b>	
5. Stel de timer voor het balbezit in		 	<b>20:00</b> <b>0 0</b>	
6. Balbezittimer is ingesteld			<b>19:59</b> <b>0 0</b>	
7. Stel periode in			<b>1234</b> <b>••••</b>	
8. Schot raakt de basketring			<b>19:58</b> <b>0 0</b>	
9. Spel is onderbroken			<b>19:50</b> <b>0 0</b>	
10. Herstart het spel & balbezittimer			<b>19:49</b> <b>0 0</b>	
10.1. 30 seconden zijn verlopen			<b>19:28</b> <b>0 0</b>	
10.2. Herstel 30 seconden			<b>19:28</b> <b>0 0</b>	







10.3. Herstart het spel			<b>19:27</b> <b>0 0</b>	
11. Speltijd is verlopen			<b>0:00</b> <b>0 0</b>	
12. Stel een nieuw spel in			<b>20:00</b> <b>0 0</b>	

- Speltimer is te laat gestopt: stel het verschil bij met  en .
- Druk op  om de hoorn te luiden.

Score		
Omschrijving	Toets	Display
1. <b>Bezoekers</b> scoren		<b>19:20</b> <b>0 1</b>
2. <b>Thuisploeg</b> scoort		<b>19:15</b> <b>1 1</b>
3. <b>Thuisploeg</b> verliest een punt of foutief opgeteld punt wordt afgetrokken		<b>19:15</b> <b>0 1</b>
4. Herstel de scores		<b>19:15</b> <b>0 0</b>

Fout		
Omschrijving	Toets	Display
1. <b>Bezoekers</b> maken een fout		<b>19:20</b> <b>0 1</b>
2. <b>Thuisploeg</b> maakt een fout		<b>19:15</b> <b>1 1</b>
3. <b>Thuisploeg</b> maakt een tweede fout		<b>19:15</b> <b>2 1</b>
4. Herstel		<b>19:15</b> <b>0 0</b>

- Druk op  of  om te schakelen tussen de thuisploeg en de bezoekers. Druk op  of  r bonuspunten.

Opteltimer				
Omschrijving	Toets		Display	Alarm
	Timer	Shot Clock		
1. Selecteer spelmodus			<b>20:00</b> <b>0 0</b>	
2. Wis vorige instellingen			<b>0:00</b> <b>0 0</b>	
3. Stel het scorebord in optelmodus			<b>0:00</b> <b>0 0</b>	
4. Stel de tijd in (bv. 20 min.)	 		<b>20:00</b> <b>0 0</b>	
5. Roep de laatste instellingen op			<b>20:00</b> <b>0 0</b>	

6. Speltijd keert terug naar 0:00			0:00 0 0	
7. Start het spel en de balbezittimer			0:01 0 0	
8. Spel is onderbroken			0:09 0 0	
9. Herstel de balbezittimer			0:09 0 0	
10. Herstart het spel			0:10 0 0	
11. Stop de balbezittimer			0:19 0 0	
12. Speltijd is verlopen			20:00 0 0	
13. Herstel speltijd			0:00 0 0	

- Speltimer is te laat gestopt: stel het verschil bij met en .
- Druk op en daarna op om naar de aftelmodus terug te keren

## B. SCORE & SETS (volleybal, badminton, tafeltennis)

Deze spelmodus geeft de gewonnen sets en de score weer.

Bovenste rij: score (max. 99)

Onderste rij: sets (max. 199)





Score / sets / opslag		
Omschrijving	Toets	Display
1. Selecteer spelmodus		0 0 0 0
2. Thuisploeg / bezoekers slaan eerste op		• 0 0 0 0
3. <b>Thuisploeg</b> scoort		1 0 0 0
4. <b>Bezoekers</b> scoren		1 1 0 0
5. <b>Bezoekers</b> winnen de eerste set		1 1 0 1
6. Ploegen wisselen van kant		1 1 1 0
7. Herstel scores		0 0 0 0



- Druk op om een punt in te trekken.
- Druk op en geef het exacte puntenaantal in indien u een fout heeft begaan.

### C. CHRONOMETER

Bovenste rij: minuten en seconden (max. 59:59)

Onderste rij: uren (max. 199) en 1/100 seconde (max. 99)

Chronometer		
Omschrijving	Toets	Display
1. Selecteer spelmodus		<b>0:00</b> <b>00</b>
2. Start de chronometer		<b>0:00</b> <b>01</b>
3. Stop de chronometer		<b>15:24</b> <b>2 93</b>
4. Herstel de chronometer		<b>0:00</b> <b>00</b>













- Druk op  terwijl de chronometer loopt om de tijd op de display te stoppen. De chronometer blijft intern echter doorlopen. UP knippert op de display. Druk op  de chronometer verder op de display te laten lopen.



### D. WEDSTRIJD- & HOUDGREEPTIMER (judo)

Deze modus geeft de wedstrijdduur en de verstreken tijd van de houdgreep aan.

Bovenste rij: wedstrijdduur (max. 99:59)

Onderste rij: tijdsduur van de houdgreep (max. 30)

Omschrijving	Toets		Display
	Timer	Shot Clock	
1. Selecteer spelmodus			<b>5:00</b> <b>30</b>
2. Stel de tijd in (bv. 5 min.)	 		<b>5:00</b> <b>30</b>
3. Sla de tijdsduur van de houdgreep in het geheugen op			<b>5:00</b> <b>0</b>
4. Herstel de tijdsduur van de houdgreep indien nodig		 	
5. Start het gevecht			<b>5:00</b> <b>1</b>
6. Indien er geen houdgreep is, pauzeer en herstel de tijdsduur van de houdgreep		 + 	<b>4:53</b> <b>0</b>
7. Houdgreep			<b>4:53</b> <b>1</b>
8. Stop het gevecht tijdens een houdgreep, pauzeer de houdgreeptimer			<b>4:35</b> <b>12</b>
9. Hervat het gevecht en de houdgreeptimer			<b>4:34</b> <b>13</b>
10. Judoka heeft zich uit houdgreep bevrijd			<b>4:25</b> <b>22</b>

	10.1. Volgende houdgreep			<b>1:31</b> <b>1</b>
	10.2. 30 seconden zijn verlopen, het gevecht wordt automatisch stilgelegd, alarm luidt			<b>1:00</b> <b>30</b>
	11. Wedstrijdduur is verlopen, alarm luidt niet indien een judoka de andere judoka in de houdgreep houdt			<b>0:00</b> <b>22</b>
	12. Herstel de wedstrijd		RESET TIMER	<b>5:00</b> <b>0</b>



















- De timer werd te laat gestopt: stel het verschil bij met  en .
- Een judoka in houdgreep heeft al een waza-ari (wordt ippon na 25 seconden): druk op  tijdens de houdgreep. 25 verschijnt onderaan links op de display en het alarm luidt nadat de 25 seconden zijn verlopen. Druk opnieuw op  om de 25 seconden van de display te wissen.
- Het gevecht eindigt met een houdgreep (timer geeft tijdens een houdgreep 0:00 weer): het gevecht gaat door zonder alarm zodat de houdgreeptimer doorloopt. Indien de houdgreep wordt gelost, druk op . Het alarm luidt en het gevecht eindigt.

### E. AFELTIMER VOOR RONDEN & PAUZES (boksen)

Deze spelmodus geeft de rondetijden en het rondenummer weer.

Bovenste rij: rondetijd (max. 99:59)

Onderste rij: rondenummer (max. 99)

Afteltimer voor rondes & pauzes				
Omschrijving	Toets		Display	Alarm
	Timer	Shot Clock		
1. Selecteer spelmodus			<b>0:00</b> <b>0</b>	
2. Stel rondetijd in (bv. 3 min.)	 		<b>3:00</b> <b>0</b>	
3. Sla de tijd in het geheugen op		RESET TIMER	<b>0:00</b> <b>0</b>	
4. Stel de pauzeduur in (bv. 1 min.)	 		<b>1:00</b> <b>0</b>	
5. Sla de tijd in het geheugen op		RESET TIMER	<b>0:00</b> <b>0</b>	
6. Stel het aantal rondes in (bv. 3 rondes)	 		<b>0:00</b> <b>3</b>	
7. Keer terug naar de tijdsweergave		RESET TIMER	<b>3:00</b> <b>1</b>	
8. Start het gevecht		START /STOP	<b>2:59</b> <b>1</b>	
9. Onderbreek het gevecht		START /STOP	<b>2:35</b> <b>1</b>	
10. Hervat het gevecht		START /STOP	<b>2:34</b> <b>1</b>	
11. Een bokser wordt tegen de grond geslagen			<b>1:34</b> <b>1</b>	
12. Het gevecht hervat			<b>1:28</b> <b>1</b>	



↓	12.1. Een bokser wordt tegen de grond geslagen			<b>1:20</b> <b>1</b>	
	12.2. 10 seconden verlopen, stop de aftel- en rondetimer			<b>1:10</b> <b>1</b>	
	12.3. Het gevecht is voorbij, luid het alarm			<b>1:10</b> <b>1</b>	

13. Eerste ronde is voorbij			<b>0:00</b> <b>1</b>	
14. Pauze			<b>0:59</b> <b>1</b>	
15. Einde van de pauze			<b>0:00</b> <b>1</b>	
16. Volgende rondeduur en -nummer verschijnen op de display			<b>3:00</b> <b>2</b>	
17. Aantal ingestelde rondes zijn voorbij			<b>0:00</b> <b>3</b>	
18. Begin een nieuw gevecht			<b>3:00</b> <b>1</b>	

- De wedstrijdtimer is te laat gestopt: stel de timer bij met en ; stel de ronde bij met .
- De timer verstrijkt (0:00) terwijl een bokser op de mat ligt: het gevecht loopt door zonder alarm zodat het aftellen niet wordt onderbroken.
- Wijzigen van de ronde-/pauzeduur: druk op en hestel.
- In de laatste ronde wordt de pauzetimer niet meer weergegeven.

## F. ELEKTRONISCHE METRONOOM

Bovenste rij: ritme

Rij onderaan links: aantal pieptonen per minuut

Rij onderaan rechts: lengte van een piepton

Elektronische metronoom			
Omschrijving	Toets	Display	Alarm
Stel de lengte van de piepton in		<b>0</b> <b>120 6</b>	
Stel het aantal pieptonen in		<b>0</b> <b>113 6</b>	
Start de metronoom		<b>1</b> <b>113 6</b>	
Stop de metronoom		<b>5</b> <b>113 6</b>	
Herstel de metronoom		<b>0</b> <b>113 6</b>	

















**G. GEPROGRAMMEERDE TIMER** (intervaltraining)

Deze timer telt af en geeft max. 9 time periodes weer.

Bovenste rij: timer (max. 99:59)

Rij onderaan links: aantal herhalingen (max. 9)

Rij onderaan rechts: programmanummer (max. 9)

<b>Geprogrammeerde timer</b>			
<b>Omschrijving</b>	<b>Toets</b>	<b>Display</b>	<b>Alarm</b>
1. Stel de tijd in voor programma 1 (P1)		<b>5:00</b> <b>1 P1</b>	
2. Sla P1 in het geheugen op enter en geef de tijden voor de volgende programma's in indien nodig.		<b>0:00</b> <b>1 P2</b>	
3. Vervolledig de programmering. Stel het aantal herhalingen in met  van de shot clock. Druk op  en  . De huidige ronde wordt weergegeven en de timer stopt.		<b>5:00</b> <b>1 P1</b>	
4. P1 begint af te tellen en het alarm luidt wanneer de timer 0:00 bereikt. Programma P2 wordt gestart. Een ronde bestaat uit het voltooien van alle programma's.		<b>4:59</b> <b>1 P1</b> <b>0:00</b> <b>1 P2</b> <b>3:00</b> <b>1 P3</b> <b>0:00</b> <b>1 P4</b> <b>5:00</b> <b>1 P5</b> . . . <b>4:59</b> <b>2 P1</b>	     
5. Stop		<b>2:28</b> <b>9 P1</b>	
7. Terug naar het begin van het programma		<b>5:00</b> <b>0 P1</b>	

- Wijzigen van de geprogrammeerde tijden: druk op  en herprogrammeer.





**H. KLOK & ALARM**

Dit scorebord geeft het uur weer in 12h-formaat. Tijdens het instellen van het uur wordt het uur echter in 24h-formaat weergegeven.

Bovenste rij: uren en minuten

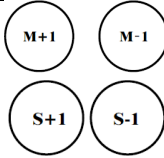
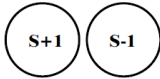
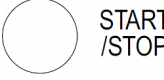

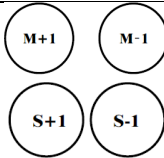
Onderste rij: seconden

<b>Klok &amp; alarm</b>			
<b>Omschrijving</b>	<b>Toets</b>		<b>Display</b>
	Timer	Shot Clock	
1. Stop de klok om het uur in te stellen			<b>0:00</b> <b>00</b>

2. Stel het uur en de minuten in met de toetsen onder de timer. Gebruik de toetsen onder de shot clock om de seconden in te stellen			<b>14:49</b> <b>13</b>
3. Bevestig			<b>2:49</b> <b>13</b>
4. Alarmmodus			<b>12:00</b> <b>AL of</b>
5. Alarm aan/uit			<b>12:00</b> <b>AL on</b>
6. Stel de alarmtijd in			<b>13:41</b> <b>AL on</b>
7. Keer terug naar de tijdweergave			<b>2:51</b> <b>25</b>

- Het scorebord luidt 5 maal wanneer de alarmtijd is bereikt.
- De huidige tijd en alarmtijd worden bij een stroomonderbreking niet in het geheugen opgeslagen.

## I. ANDERE FUNCTIES

- Druk op  om het alarmsignaal te luiden.
- Regel het volume van het alarm met .
- Druk op  (indien de led brandt) om de laatste minuut in seconden weer te geven.

## 5. Technische specificaties

voeding ..... 100-240 V~, 12 VDC - 3 A  
 verbruik..... < 25 W  
 leesbaar tot max..... 50 m  
 nauwkeurigheid ..... < 0.5 s per dag  
 afmetingen..... 620 x 405 x 275 mm  
 gewicht..... 4.75 kg

**Gebruik dit toestel enkel met originele accessoires. Velleman nv is niet aansprakelijk voor schade of kwetsuren bij (verkeerd) gebruik van dit toestel. Voor meer informatie over dit product en de laatste versie van deze handleiding, zie [www.velleman.eu](http://www.velleman.eu). De informatie in deze handleiding kan te allen tijde worden gewijzigd zonder voorafgaande kennisgeving.**

### © AUTEURSRECHT

**Velleman nv heeft het auteursrecht voor deze handleiding. Alle wereldwijde rechten voorbehouden.** Het is niet toegestaan om deze handleiding of gedeelten ervan over te nemen, te kopiëren, te vertalen, te bewerken en op te slaan op een elektronisch medium zonder voorafgaande schriftelijke toestemming van de rechthebbende.

# MODE D'EMPLOI

## 1. Introduction

### Aux résidents de l'Union européenne

#### Informations environnementales importantes concernant ce produit



Ce symbole sur l'appareil ou l'emballage indique que l'élimination d'un appareil en fin de vie peut polluer l'environnement. Ne pas jeter un appareil électrique ou électronique (et des piles éventuelles) parmi les déchets municipaux non sujets au tri sélectif ; une déchetterie traitera l'appareil en question. Renvoyer l'appareil à votre fournisseur ou à un service de recyclage local. Il convient de respecter la réglementation locale relative à la protection de l'environnement.

**En cas de questions, contacter les autorités locales pour élimination.**

Nous vous remercions de votre achat ! Lire attentivement le présent mode d'emploi avant la mise en service de l'appareil. Si l'appareil a été endommagé pendant le transport, ne pas l'installer et consulter votre revendeur.

## 2. Description

1. interrupteur marche/arrêt
2. adaptateur secteur

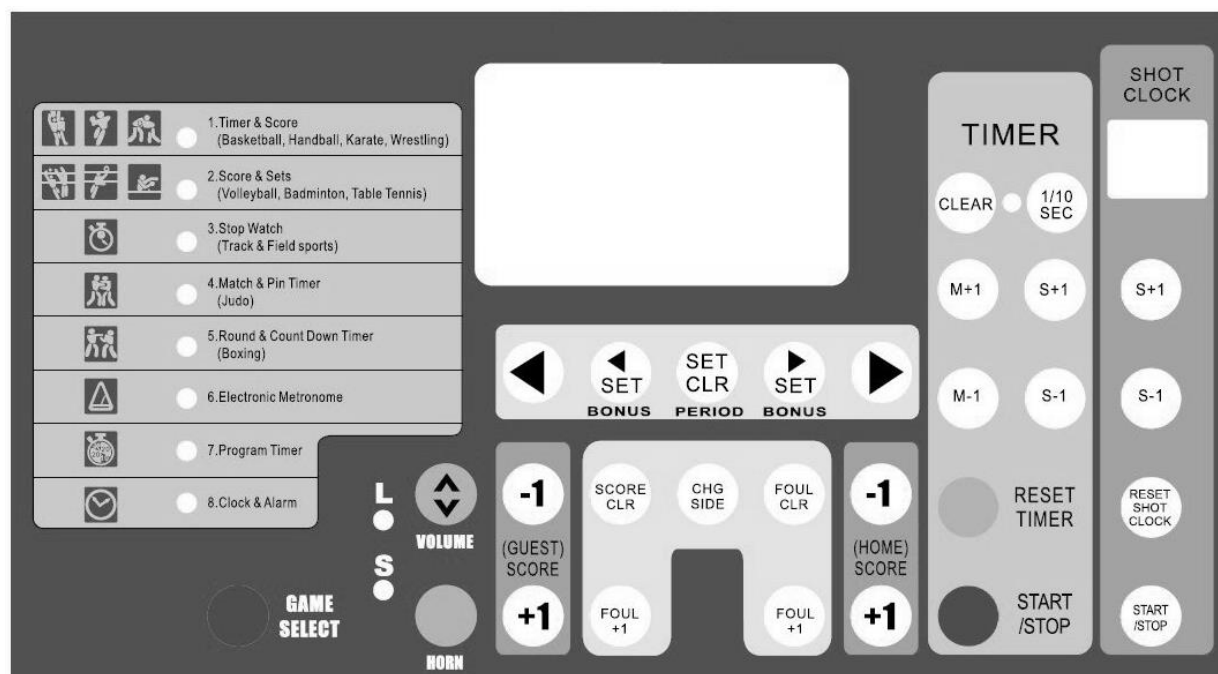
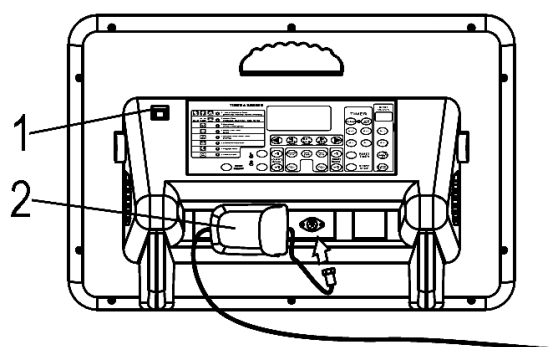

### 3. Installation du tableau

- Alimenter le tableau en connectant l'adaptateur secteur à l'entrée d'alimentation (voir ill. 1). Insérer l'adaptateur secteur dans une prise de courant.
- Allumer le tableau à l'aide de l'interrupteur marche/arrêt et patienter jusqu'à ce que la phase d'initialisation se termine.
- Enfoncer **GAME SELECT**. La DEL du mode de jeu chronomètre et score clignote.
- Enfoncer **CLEAR**. Ensuite, régler le chronomètre avec **M+1/M-1** et **S+1/S-1**, et le chronomètre de possession de balle avec **S+1/S-1** sous le panneau SHOT CLOCK.
- Enfoncer **START/STOP** sous TIMER pour démarrer les deux chronomètres et renfoncer **START/STOP** après quelques secondes.
- Enfoncer **RESET TIMER** et **RESET SHOT CLOCK**. Le tableau affichera le mode utilisé en dernier.
- Enfoncer **GAME SELECT** pour quitter le menu de paramétrage.















### 4. Emploi





#### A. CHRONOMÈTRE & SCORE (le basket-ball, le handball, le karaté, la lutte)



Ce mode affiche le temps restant et le score.





Affichage supérieur : durée du match (max. 99:59)





Affichage inférieur : score (max. 199)





Compte à rebours				
Description	Touche		Affichage	Avertisseur
	Timer	Shot Clock		
1. Sélectionner le mode			<b>0:00</b> <b>0 0</b>	
2. Afficher le contenu mémorisé			<b>20:00</b> <b>0 0</b>	
3. Effacer les dernières données			<b>0:00</b> <b>0 0</b>	
4. Déterminer la durée du match (p.ex. 20 min)	 		<b>20:00</b> <b>0 0</b>	
5. Déterminer la durée de possession du ballon		 	<b>20:00</b> <b>0 0</b>	
6. Mémorisation de la durée de possession du ballon			<b>19:59</b> <b>0 0</b>	
7. Déterminer la période			<b>1234</b> <b>••••</b>	
8. Le ballon heurte l'arceau			<b>19:58</b> <b>0 0</b>	
9. Interruption de la partie			<b>19:50</b> <b>0 0</b>	
10. Reprise de la partie			<b>19:49</b> <b>0 0</b>	
10.1. Les 30 secondes sont écoulées			<b>19:28</b> <b>0 0</b>	
10.2. Réinitialisation des 30 secondes			<b>19:28</b> <b>0 0</b>	







10.3. Reprise de la partie			<b>19:27</b> <b>0 0</b>	
11. Durée de la partie écoulée			<b>0:00</b> <b>0 0</b>	
12. Réinitialisation de la durée de la partie			<b>20:00</b> <b>0 0</b>	

- Arrêt tardif du compte à rebours : ajuster la différence avec  et .
- Enfoncer  pour faire retentir l'avertisseur.

Score		
Description	Touche	Affichage
1. L'équipe <b>visiteuse</b> marque un point		<b>19:20</b> <b>0 1</b>
2. L'équipe <b>recevante</b> marque un point		<b>19:15</b> <b>1 1</b>
3. L'équipe <b>recevante</b> perd un point		<b>19:15</b> <b>0 1</b>
4. Remise des scores à zéro		<b>19:15</b> <b>0 0</b>

Faute		
Description	Touche	Affichage
1. L'équipe <b>visiteuse</b> commet une faute		<b>19:20</b> <b>0 1</b>
2. L'équipe <b>recevante</b> commet une faute		<b>19:15</b> <b>1 1</b>
3. L'équipe <b>recevante</b> commet une seconde faute		<b>19:15</b> <b>2 1</b>
4. Remise à zéro		<b>19:15</b> <b>0 0</b>

- Enfoncer  ou  pour commuter entre les deux équipes. Enfoncer  ou  pour attribuer des points bonus.

Chronomètre				
Description	Touche		Affichage	Avertisseur
	Timer	Shot Clock		
1. Sélectionner le mode			<b>20:00</b> <b>0 0</b>	
2. Effacer les dernières données			<b>0:00</b> <b>0 0</b>	
3. Afficher le mode chrono			<b>0:00</b> <b>0 0</b>	
4. Déterminer la durée du match (p.ex. 20 min)	 		<b>20:00</b> <b>0 0</b>	
5. Afficher le contenu mémorisé			<b>20:00</b> <b>0 0</b>	

6. Retour de l'affichage de la durée vers 0:00			0:00 0 0	
7. Début de la partie			0:01 0 0	
8. Interruption de la partie			0:09 0 0	
9. Réinitialisation de la durée de possession du ballon			0:09 0 0	
10. Reprise de la partie			0:10 0 0	
11. Arrêt du chronomètre			0:19 0 0	
12. Durée de la partie écoulée			20:00 0 0	
13. Réinitialisation de la durée de la partie			0:00 0 0	

- Arrêt tardif du compte à rebours : ajuster la différence avec et .
- Enfoncer et ensuite pour revenir au compte à rebours.

### B. SCORE & MANCHES (le volley-ball, le badminton, le tennis de table)

Ce mode affiche les manches gagnées et le score.

Affichage supérieur : score (max. 99)

Affichage inférieur : manches (max. 199)





Score / manche / service		
Description	Touche	Affichage
1. Sélectionner le mode		0 0 0 0
2. L'équipe recevante/ visiteuse est au service		• 0 0 0 0
3. L'équipe <b>recevante</b> marque un point		1 0 0 0
4. L'équipe <b>visiteuse</b> marque un point		1 1 0 0
5. L'équipe <b>visiteuse</b> gagne la première manche		1 1 0 1
6. Changement de côté		1 1 1 0
7. Réinitialisation des scores		0 0 0 0



- Enfoncer pour retirer un point.
- Enfoncer et attribuer les scores exacts en cas d'erreur.

### C. CHRONOMÈTRE

Affichage supérieur : minutes et secondes (max. 59:59)

Affichage inférieur : heures (max. 199) et 1/100 de seconde (max. 99)

Chronomètre		
Description	Touche	Affichage
1. Sélectionner le mode		<b>0:00</b> <b>00</b>
2. Démarrage du chronomètre		<b>0:00</b> <b>01</b>
3. Arrêt du chronomètre		<b>15:24</b> <b>2 93</b>
4. Réinitialisation du chronomètre		<b>0:00</b> <b>00</b>













- Enfoncer  lorsque le chronomètre tourne pour arrêter le chronomètre sur l'afficheur principal. Toutefois, le chronomètre continuera à tourner en mémoire. UP clignote sur l'afficheur. Enfoncer  to pour continuer.

### D. CHRONOMÈTRE DE COMBAT & DE CLEF (le judo)



Ce mode affiche la durée du combat et le temps écoulé lors d'une immobilisation au sol.





Affichage supérieur : durée du combat (max. 99:59)

Affichage inférieur : temps écoulé lors d'une immobilisation au sol (max. 30)

Chronomètre de combat & de clef			
Description	Touche		Affichage
	Timer	Shot Clock	
1. Sélectionner le mode			<b>5:00</b> <b>30</b>
2. Déterminer la durée du match (p.ex. 5 min)	 		<b>5:00</b> <b>30</b>
3. Mémorisation de la durée max. d'une clef			<b>5:00</b> <b>0</b>
4. Réinitialiser la durée max. d'une clef si nécessaire		 	
5. Début du combat			<b>5:00</b> <b>1</b>
6. Interrompre et réinitialiser le chronomètre d'immobilisation au sol lorsqu'il n'y a pas de clef		 + 	<b>4:53</b> <b>0</b>
7. Immobilisation au sol			<b>4:53</b> <b>1</b>
8. Arrêt du combat lors d'une clef, interruption du chronomètre d'immobilisation au sol			<b>4:35</b> <b>12</b>
9. Reprise du combat et du chronomètre d'immobilisation au sol			<b>4:34</b> <b>13</b>
10. Le judoka se libère de la clef			<b>4:25</b> <b>22</b>



	10.1. Seconde immobilisation au sol			<b>1:31</b> <b>1</b>
	10.2. Les 30 secondes sont écoulées, le combat se termine automatiquement, l'avertisseur retentit			<b>1:00</b> <b>30</b>
	11. Écoulement de la durée du combat, l'avertisseur ne retentit pas lors d'une immobilisation au sol			<b>0:00</b> <b>22</b>
	12. Réinitialiser le chronomètre		RESET TIMER	<b>5:00</b> <b>0</b>

















- Arrêt tardif du chronomètre : ajuster la différence avec  et .
- Le judoka immobilisé au sol a déjà un waza-ari (ippon après 25 secondes) : enfoncer  pour démarrer le compte à rebours d'immobilisation au sol. 25 s'affiche en bas à gauche de l'afficheur. L'avertisseur retentit après l'écoulement de ces 25 secondes. Renfoncer  pour effacer l'affichage.
- La durée du combat s'écoule (le chronomètre affiche 0:00) lors d'une immobilisation au sol : le combat continue sans que l'avertisseur ne retentisse pour que le chronomètre d'immobilisation au sol ne soit pas interrompu. Enfoncer  dès que le judoka se libère de la clef. L'avertisseur retentit et le combat se termine.

### E. CHRONOMÈTRE DE ROUND & DE REPOS (la boxe)

Ce mode affiche la durée des rounds et le round.

Affichage supérieur : durée du round (max. 99:59)

Affichage inférieur : round (max. 99)

Chronomètre de round & de repos				
Description	Touche		Affichage	Avertisseur
	Timer	Shot Clock		
1. Sélectionner le mode			<b>0:00</b> <b>0</b>	
2. Déterminer la durée d'un round (p.ex. 3 min)	 		<b>3:00</b> <b>0</b>	
3. Mémoriser la durée d'un round		RESET TIMER	<b>0:00</b> <b>0</b>	
4. Déterminer la durée de la période de repos (p.ex. 1 min)	 		<b>1:00</b> <b>0</b>	
5. Mémoriser la durée de la période de repos		RESET TIMER	<b>0:00</b> <b>0</b>	
6. Déterminer le nombre de rounds (p.ex. 3 rounds)	 		<b>0:00</b> <b>3</b>	
7. Retour vers l'affichage normal		RESET TIMER	<b>3:00</b> <b>1</b>	
8. Démarrer le combat		START /STOP	<b>2:59</b> <b>1</b>	
9. Interrompre le combat		START /STOP	<b>2:35</b> <b>1</b>	
10. Reprise du combat		START /STOP	<b>2:34</b> <b>1</b>	
11. Un boxeur est au tapis			<b>1:34</b> <b>1</b>	

12. Le combat continue			<b>1:28</b> <b>1</b>	
12.1. Un boxeur est au tapis			<b>1:20</b> <b>1</b>	
12.2. 10 secondes s'écoulent, arrêt du compte à rebours et du chronomètre de round			<b>1:10</b> <b>1</b>	
12.3. Le combat se termine, l'avertisseur retentit			<b>1:10</b> <b>1</b>	

13. Le premier round se termine			<b>0:00</b> <b>1</b>	
14. Chronomètre de la période de repos			<b>0:59</b> <b>1</b>	
15. Fin du repos			<b>0:00</b> <b>1</b>	
16. Affichage du chronomètre du round suivant			<b>3:00</b> <b>2</b>	
17. Achèvement de la totalité du nombre de rounds			<b>0:00</b> <b>3</b>	
18. Commencer un nouveau combat			<b>3:00</b> <b>1</b>	

- Arrêt tardif du chronomètre : ajuster la différence avec et ; enfoncer la touche pour modifier la différence de rounds.
- Le chronomètre affiche 0:00 pendant le compte des 10 secondes de l'arbitre : le combat continue sans que l'avertisseur ne retentisse pour le compte ne soit pas interrompu.
- Modifier le chronomètre du round/de la période de repos : enfoncer .
- Le chronomètre de la période de repos ne sera pas affiché dans le dernier round.

## F. MÉTRONOME ÉLECTRONIQUE

Affichage supérieur : rythme

Affichage inférieur gauche : nombre de bips sonores par minute

Affichage inférieur droit : longueur d'un bip sonore

Métronome électronique			
Description	Touche	Affichage	Avertisseur
Déterminer la longueur d'un bip sonore		<b>0</b> <b>120 6</b>	
Déterminer le nombre de bips sonores		<b>0</b> <b>113 6</b>	
Démarrer le métronome		<b>1</b> <b>113 6</b>	
Arrêter le métronome		<b>5</b> <b>113 6</b>	
Réinitialiser le métronome		<b>0</b> <b>113 6</b>	

















**G. CHRONOMÈTRE PROGRAMMÉ** (entraînement par intervalle)

Le chronomètre peut être programmé de manière à ce qu'il affiche le compte à rebours et max. 9 périodes.

Affichage supérieur : chronomètre (max. 99:59)

Affichage inférieur gauche : nombre de répétitions (max. 9)

Affichage inférieur droit : numéro du programme (max. 9)

<b>Chronomètre programmé</b>			
Description	Touche	Affichage	Avertisseur
1. Déterminer la durée du premier programme (P1)		<b>5:00</b> <b>1 P1</b>	
2. Mémoriser P1 et déterminer la durée des programmes suivants si nécessaire		<b>0:00</b> <b>1 P2</b>	
3. Achèvement de la programmation. Déterminer le nombre de répétitions avec  . Enfoncer  et  . Le programme s'affiche et le chronomètre s'arrête:		<b>5:00</b> <b>1 P1</b>	
4. Le programme P1 démarre et l'avertisseur retentit lorsque le chronomètre affiche 0:00. Le programme P2 démarre et ainsi de suite jusqu'à ce que tous les programmes sont terminés.		<b>4:59</b>	
		<b>1 P1</b>	
		<b>0:00</b>	
		<b>1 P2</b>	
		<b>3:00</b>	
		<b>1 P3</b>	
		<b>0:00</b>	
		<b>1 P4</b>	
		<b>5:00</b>	
		<b>1 P5</b>	
		.	
		.	
		.	
		<b>4:59</b>	
		<b>2 P1</b>	
5. Arrêt		<b>2:28</b> <b>9 P1</b>	
7. Retour vers le début du programme		<b>5:00</b> <b>0 P1</b>	

- Modifier la durée d'un programme : enfoncer  et reprogrammer les durées.



**H. HORLOGE & ALARME**

Ce tableau affiche l'heure au format 12h mais commute vers le format 24h lors de la configuration.

Affichage supérieur : heures et minutes

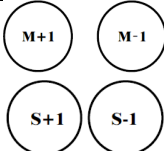

Affichage inférieur : secondes

<b>Horloge &amp; alarme</b>			
Description	Touche		Affichage
	Timer	Shot Clock	
1. Arrêt de l'horloge			<b>0:00</b> <b>00</b>

2. Configuration de l'heure, des minutes et des secondes			<b>14:49</b> <b>13</b>
3. Confirmation			<b>2:49</b> <b>13</b>
4. Mode d'alarme			<b>12:00</b> <b>AL of</b>
5. Activation/désactivation de l'alarme			<b>12:00</b> <b>AL on</b>
6. Configuration de l'heure de l'alarme			<b>13:41</b> <b>AL on</b>
7. Retour vers l'affichage de l'heure			<b>2:51</b> <b>25</b>

- Une alarme amorcée retentit pendant 5 secondes.
- L'heure et l'heure de l'alarme ne seront pas sauvegardées lors d'une coupure de courant.

## I. AUTRES FONCTIONS

- Enfoncer  pour faire retentir l'avertisseur.
- Régler le volume de l'avertisseur avec .
- Enfoncer  (lorsque la LED s'allume) pour afficher la dernière minute en secondes.

## 5. Spécifications techniques

alimentation .....	100-240 V~, 12 VDC - 3 A
consommation .....	< 25 W
lisible jusqu'à max. ....	50 m
précision horloge .....	< 0.5 s par jour
dimensions.....	620 x 405 x 275 mm
poids .....	4.75 kg

**N'employer cet appareil qu'avec des accessoires d'origine. Velleman SA ne peut, dans la mesure conforme au droit applicable être tenue responsable des dommages ou lésions (directs ou indirects) pouvant résulter de l'utilisation de cet appareil. Pour plus d'information concernant cet article et la dernière version de cette notice, visiter notre site web [www.velleman.eu](http://www.velleman.eu). Les spécifications et le contenu de ce mode d'emploi peuvent être modifiés sans notification préalable.**

### © DROITS D'AUTEUR

**Velleman SA est l'ayant droit des droits d'auteur de ce mode d'emploi. Tous droits mondiaux réservés.** Toute reproduction, traduction, copie ou diffusion, intégrale ou partielle, du contenu de ce mode d'emploi par quelque procédé ou sur tout support électronique que ce soit est interdite sans l'accord préalable écrit de l'ayant droit.

# MANUAL DEL USUARIO

## 1. Introducción

### A los ciudadanos de la Unión Europea



#### Importantes informaciones sobre el medio ambiente concerniente a este producto

Este símbolo en este aparato o el embalaje indica que, si tira las muestras inservibles, podrían dañar el medio ambiente. No tire este aparato (ni las pilas, si las hubiera) en la basura doméstica; debe ir a una empresa especializada en reciclaje. Devuelva este aparato a su distribuidor o a la unidad de reciclaje local. Respete las leyes locales en relación con el medio ambiente.

**Si tiene dudas, contacte con las autoridades locales para residuos.**

¡Gracias por elegir Pere! Lea atentamente las instrucciones del manual antes de usar el aparato. Si ha sufrido algún daño en el transporte no lo instale y póngase en contacto con su distribuidor.

## 2. Descripción

1. interruptor ON/OFF
2. adaptador de red

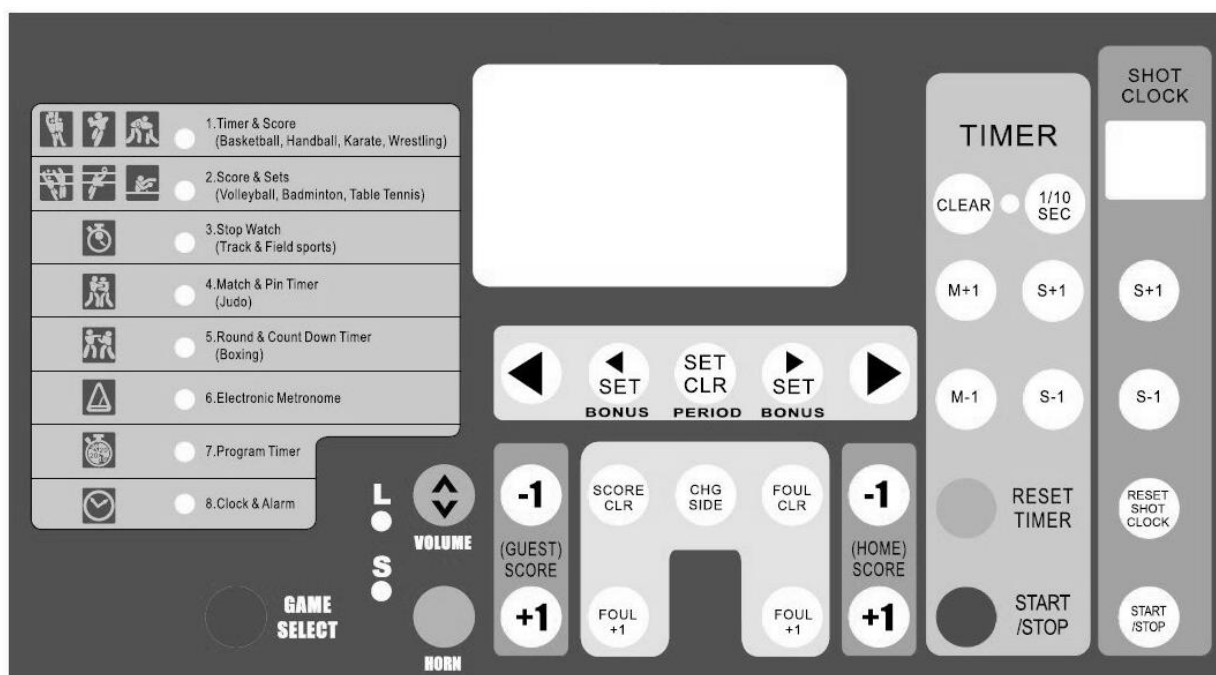
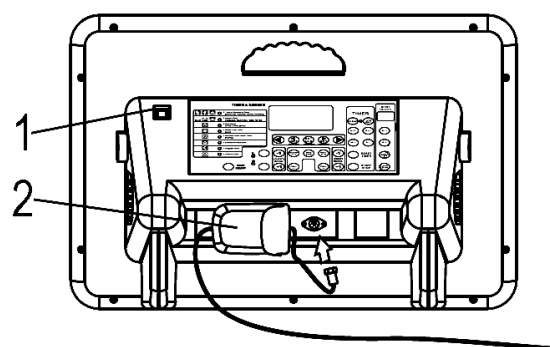

### 3. Instalar el marcador

- Alimente el marcador al conectar el adaptador de red a la entrada de alimentación (véase fig. 1). Introduzca el adaptador de red en un enchufe.
- Active el marcador con el interruptor ON/OFF. Después de algunos segundos el marcador está iniciado.
- Pulse **GAME SELECT**. El LED al lado del cronómetro y la puntuación parpadea.
- Pulse **CLEAR**. Luego, ajuste el cronómetro con **M+1/M-1** y **S+1/S-1**. Ajuste el cronómetro de 'estar en posesión del balón' con **S+1/S-1** del SHOT CLOCK.
- Pulse **START/STOP** del menú TIMER para activar los dos cronómetros y vuelva a pulsar **START/STOP** después de algunos segundos.
- Pulse **RESET TIMER** y **RESET SHOT CLOCK**. El marcador visualizará los últimos datos guardados.
- Pulse **GAME SELECT** para salir del menú de ajuste.















### 4. Uso

#### A. CRONOMETRO & VISUALIZACIÓN DE LOS PUNTOS (el baloncesto, el balonmano, el kárate, la lucha)

Este modo visualiza el tiempo de juego restante y la puntuación.

Visualización superior: duración del partido (máx. 99:59)

Visualización inferior: la puntuación (máx. 199)

Cuenta atrás				
Descripción	Tecla		Visualización	Buzzer
	Timer	Shot Clock		
1. Seleccionar el modo			<b>0:00</b> <b>0 0</b>	
2. Recordar los últimos ajustes guardados			<b>20:00</b> <b>0 0</b>	
3. Borrar los últimos datos			<b>0:00</b> <b>0 0</b>	
4. Determinar la duración del partido (p.ej. 20 min.)	 		<b>20:00</b> <b>0 0</b>	
5. Determinar la duración de la posesión del balón		 	<b>20:00</b> <b>0 0</b>	
6. Memorizar la duración de la posesión del balón			<b>19:59</b> <b>0 0</b>	
7. Determinar el período			<b>1234</b> <b>••••</b>	
8. El balón da con el aro			<b>19:58</b> <b>0 0</b>	
9. Interrumpir el partido			<b>19:50</b> <b>0 0</b>	
10. Continuar con el partido			<b>19:49</b> <b>0 0</b>	
10.1. Han pasado los 30 segundos			<b>19:28</b> <b>0 0</b>	
10.2. Reinicializar los 30 segundos			<b>19:28</b> <b>0 0</b>	

10.3. Continuar con el partido			<b>19:27</b> <b>0 0</b>	
11. Tiempo del partido transcurrido			<b>0:00</b> <b>0 0</b>	
12. Reinicializar la duración del partido			<b>20:00</b> <b>0 0</b>	

- El temporizador se ha parado demasiado tarde: ajuste la diferencia con y .
- Pulse para hacer sonar el marcador.

### La puntuación

Descripción	Tecla	Visualización
1. El equipo <b>visitante</b> marca un punto		<b>19:20</b> <b>0 1</b>
2. El equipo <b>local</b> marca un punto		<b>19:15</b> <b>1 1</b>
3. El equipo <b>local</b> pierde un punto		<b>19:15</b> <b>0 1</b>
4. Reinicialización de los puntos		<b>19:15</b> <b>0 0</b>

### Error

Descripción	Tecla	Visualización
1. El equipo <b>visitante</b> comete un error		<b>19:20</b> <b>0 1</b>
2. El equipo <b>local</b> comete un error		<b>19:15</b> <b>1 1</b>
3 El equipo <b>local</b> comete un segundo error		<b>19:15</b> <b>2 1</b>
4. Reinicialización		<b>19:15</b> <b>0 0</b>

- Pulse o para conmutar entre los dos equipos. Pulse o para atribuir puntos adicionales.

### Cronómetro

Descripción	Tecla		Visualización	Buzzer
	Timer	Shot Clock		
1. Seleccionar el modo			<b>20:00</b> <b>0 0</b>	
2. Borrar los últimos datos			<b>0:00</b> <b>0 0</b>	
3. Visualizar el modo crono			<b>0:00</b> <b>0 0</b>	
4. Determinar la duración del partido (p.ej. 20 min.)			<b>20:00</b> <b>0 0</b>	
5. Visualizar el contenido guardado			<b>20:00</b> <b>0 0</b>	

6. Tiempo del partido vuelve a 0:00			0:00 0 0	
7. Principio del partido			0:01 0 0	
8. Interrumpir el partido			0:09 0 0	
9. Reinicializar la duración de la posesión del balón			0:09 0 0	
10. Seguir el partido			0:10 0 0	
11. Parar el cronómetro			0:19 0 0	
12. Tiempo transcurrido del partido			20:00 0 0	
13. Reinicializar la duración del partido			0:00 0 0	

- El temporizador se ha parado demasiado tarde: ajuste la diferencia con y .
- Pulse y luego para volver a la cuenta atrás.

## B. PUNTUACIÓN & SETS (el balonvolea, el bádminton, el tenis de mesa)

Este modo visualiza los sets ganados y la puntuación.

Visualización superior: puntuación (máx. 99)

Visualización inferior: sets (máx. 199)

Puntuación / set / servicio		
Descripción	Tecla	Visualización
1. Seleccionar el modo		0 0 0 0
2. El equipo local/ visitante tiene el servicio		• 0 0 0 0
3. El equipo <b>local</b> marca un punto		1 0 0 0
4. El equipo <b>visitante</b> marca un punto		1 1 0 0
5. El equipo <b>visitante</b> gana el primer set		1 1 0 1
6. Cambiar el lado		1 1 1 0
7. Reinicializar la puntuación		0 0 0 0





- Pulse para restar un punto.
- Pulse y introduzca los puntos exactos en caso de un error.





### C. CRONÓMETRO

Visualización superior: minutos y segundos (máx. 59:59)

Visualización inferior: horas (máx. 199) y 1/100 de un segundo (máx. 99)

Cronómetro		
Descripción	Tecla	Visualización
1. Seleccionar el modo		<b>0:00</b> <b>00</b>
2. Iniciar el cronómetro		<b>0:00</b> <b>01</b>
3. Parar el cronómetro		<b>15:24</b> <b>2 93</b>
4. Reinicializar el cronómetro		<b>0:00</b> <b>00</b>













- Pulse  mientras el cronómetro está funcionando para parar el cronómetro en la pantalla principal. Sin embargo, el cronómetro continúa funcionando en la memoria. UP parpadea en la pantalla. Pulse  para continuar.



### D. CRONÓMETRO COMBATE Y PIN TIMER (el judo)





Este modo visualiza la duración del combate y el tiempo transcurrido si hay una inmovilización en el suelo.

Visualización superior: duración del combate (máx. 99:59)

Visualización inferior: tiempo transcurrido si hay una inmovilización en el suelo (máx. 30)

Cronómetro combate & PIN Timer			
Descripción	Tecla		Visualización
	Timer	Shot Clock	
1. Seleccionar el modo			<b>5:00</b> <b>30</b>
2. Determinar la duración del partido (p.ej. 5 min.)	 		<b>5:00</b> <b>30</b>
3. Memorizar la duración máx. de una llave			<b>5:00</b> <b>0</b>
4. Reinicializar la duración máx. de una llave si fuera necesario		 	
5. Inicio del combate			<b>5:00</b> <b>1</b>
6. Interrumpir y reinicializar el cronómetro de inmovilización en el suelo si no hay una llave		 + 	<b>4:53</b> <b>0</b>
7. Inmovilización en el suelo			<b>4:53</b> <b>1</b>
8. Parar el combate si hay una llave, interrumpir el cronómetro de inmovilización en el suelo			<b>4:35</b> <b>12</b>
9. Seguir el combate y el cronómetro de inmovilización en el suelo			<b>4:34</b> <b>13</b>
10. El judoca se libera de la llave			<b>4:25</b> <b>22</b>

↓	10.1. Segunda inmovilización en el suelo			<b>1:31</b> <b>1</b>
	10.2. Se han transcurrido los 30 segundos, el combate se termina automáticamente, el zumbador suena			<b>1:00</b> <b>30</b>
	11. Se ha transcurrido la duración del combate, el zumbador no suena si hay una inmovilización en el suelo			<b>0:00</b> <b>22</b>
	12. Reinicializar el cronómetro		RESET TIMER	<b>5:00</b> <b>0</b>

















- El temporizador se ha parado demasiado tarde: ajuste la diferencia con  y .
- El judoka inmovilizado en el suelo ya tiene un waza-ari (ippon después de 25 segundos): pulse  para activar la cuenta atrás de inmovilización en el suelo. 25 se visualiza en la parte inferior izquierda de la pantalla. El zumbador suena después de estos 25 segundos. Vuelva a pulsar  para borrar la pantalla.
- El combate se termina (el cronómetro visualiza 0:00) si hay una inmovilización en el suelo: el combate continúa sin que el zumbador suene para no interrumpir el cronómetro de inmovilización en el suelo. Pulse  en cuanto el judoka se libera de la llave. El zumbador suena y el combate se termina.

### E. CRONÓMETRO ROUND & PAUSA (boxing)

Este modo visualiza el tiempo por vuelta y el número de vueltas.

Visualización superior: tiempo por vuelta (máx. 99:59)

Visualización inferior: número de vuelta (máx. 99)

Cronómetro round & cuenta atrás				
Descripción	Tecla		Visualización	Zumbador
	Timer	Shot Clock		
1. Seleccionar el modo			<b>0:00</b> <b>0</b>	
2. Determinar la duración de una vuelta (p.ej. 3 min.)	 		<b>3:00</b> <b>0</b>	
3. Memorizar la duración de una vuelta			<b>0:00</b> <b>0</b>	
4. Determinar la duración de la pausa (p.ej. 1 min.)	 		<b>1:00</b> <b>0</b>	
5. Memorizar la duración de la pausa			<b>0:00</b> <b>0</b>	
6. Determinar el número de vueltas (p.ej. 3 vueltas)	 		<b>0:00</b> <b>3</b>	
7. Volver a la visualización normal			<b>3:00</b> <b>1</b>	
8. Iniciar el combate			<b>2:59</b> <b>1</b>	
9. Interrumpir el combate			<b>2:35</b> <b>1</b>	
10. Reemprender el combate			<b>2:34</b> <b>1</b>	
11. Un bóxer está en el suelo			<b>1:34</b> <b>1</b>	

12. El combate continúa			<b>1:28</b> <b>1</b>	
12.1. Un bóxer está en el suelo			<b>1:20</b> <b>1</b>	
12.2. Se han pasado 10 segundos, parar la cuenta atrás y el cronómetro de round			<b>1:10</b> <b>1</b>	
12.3. El combate se termina, el zumbador suena			<b>1:10</b> <b>1</b>	

13. El primer round se termina			<b>0:00</b> <b>1</b>	
14. Cronómetro del tiempo de pausa			<b>0:59</b> <b>1</b>	
15. Final de la pausa			<b>0:00</b> <b>1</b>	
16. Visualización del cronómetro del siguiente round			<b>3:00</b> <b>2</b>	
17. Terminar el número de vueltas introducidas			<b>0:00</b> <b>3</b>	
18. Iniciar un nuevo combate			<b>3:00</b> <b>1</b>	

- El temporizador se ha parado demasiado tarde: ajuste la diferencia con y ; pulse la tecla para modificar la diferencia de vueltas.
- El cronómetro visualiza 0:00 durante la cuenta de los 10 segundos del árbitro: el combate continúa sin que el zumbador no suena para no interrumpir la cuenta.
- Modificar el cronómetro de la vuelta/el tiempo de pausa: pulse .
- El cronómetro del tiempo de pausa no se visualizará en la última vuelta.

### F. METRÓNOMO ELECTRÓNICO

Visualización superior: ritmo

Visualización inferior izquierda: número de bips sonoros por minuto

Visualización inferior derecha: longitud de un bip sonoro

Metrónomo electrónico			
Descripción	Tecla	Visualización	Zumbador
Determinar la longitud de un bip sonoro		<b>0</b> <b>120</b> <b>6</b>	
Determinar el número de bips sonoros		<b>0</b> <b>113</b> <b>6</b>	
Activar el metrónomo		<b>1</b> <b>113</b> <b>6</b>	
Desactivar el metrónomo		<b>5</b> <b>113</b> <b>6</b>	
Reinicializar el metrónomo		<b>0</b> <b>113</b> <b>6</b>	























**G. CRONÓMETRO PROGRAMADO** (entrenamiento por intervalo)

Es posible programar el cronómetro de manera que visualiza la cuenta atrás y máx. 9 períodos.

Visualización superior: cronómetro (máx. 99:59)

Visualización inferior izquierda: número de repeticiones (máx. 9)

Visualización inferior derecha: número del programa (máx. 9)

<b>Cronómetro programado</b>			
Descripción	Tecla	Visualización	Zumbador
1. Determinar la duración del primer programa (P1)		<b>5:00</b> <b>1 P1</b>	
2. Memorizar P1 y determinar la duración de los siguientes programas si fuera necesario		<b>0:00</b> <b>1 P2</b>	
3. Terminar la programación. Determinar el número de repeticiones con  . Pulse  y  . El programa se visualiza y el cronómetro se para:		<b>5:00</b> <b>1 P1</b>	
4. El programa P1 se activa y el zumbador suena si el cronómetro visualiza 0:00. El programa P2 se activa hasta que todos los programas se terminen.		<b>4:59</b>	
		<b>1 P1</b>	
		<b>0:00</b>	
		<b>1 P2</b>	
		<b>3:00</b>	
		<b>1 P3</b>	
		<b>0:00</b>	
		<b>1 P4</b>	
		<b>5:00</b>	
		<b>1 P5</b>	
		.	
		.	
		<b>4:59</b>	
		<b>2 P1</b>	
5. Desactivar		<b>2:28</b> <b>9 P1</b>	
7. Volver al principio del programa		<b>5:00</b> <b>0 P1</b>	

- Modificar la duración de un programa: pulse  y vuelva a programar.





**H. RELOJ & ALARMA**

El marcador visualiza la hora en el formato 12h pero conmuta al formato 24h durante el ajuste.

Visualización superior: horas y minutos

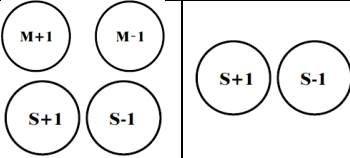
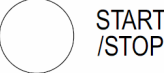

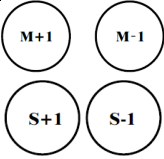
Visualización inferior: segundos

<b>Reloj &amp; alarma</b>			
Descripción	Tecla		Visualización
	Timer	Shot Clock	
1. Desactivar el reloj			<b>0:00</b> <b>00</b>

2. Ajustar la hora, los minutos y los segundos			<b>14:49 13</b>
3. Confirmación			<b>2:49 13</b>
4. Modo de alarma			<b>12:00 AL oF</b>
5. Activación/desactivación de la alarma			<b>12:00 AL on</b>
6. Ajustar la hora de la alarma			<b>13:41 AL on</b>
7. Volver a la visualización de la hora			<b>2:51 25</b>

- Una alarma activada suena durante 5 segundos.
- La hora y la hora de la alarma no se guardarán si hay una interrupción por fallo de alimentación.

## I. OTRAS FUNCIONES

- Pulse  para hacer sonar el zumbador.
- Ajuste el volumen del zumbador con .
- Pulse  (si el LED se ilumina) para visualizar el último minuto en segundos.

## 5. Especificaciones

alimentación.....	100-240 V~, 12 VDC - 3 A
consumo.....	< 25 W
legible hasta máx.....	50 m
precisión.....	< 0.5 s por día
dimensiones.....	620 x 405 x 275 mm
peso.....	4.75 kg

**Utilice este aparato sólo con los accesorios originales. Velleman NV no será responsable de daños ni lesiones causados por un uso (indebido) de este aparato. Para más información sobre este producto y la versión más reciente de este manual del usuario, visite nuestra página [www.hqpower.eu](http://www.hqpower.eu). Se pueden modificar las especificaciones y el contenido de este manual sin previo aviso.**

### © DERECHOS DE AUTOR

**Velleman NV dispone de los derechos de autor para este manual del usuario. Todos los derechos mundiales reservados.** Está estrictamente prohibido reproducir, traducir, copiar, editar y guardar este manual del usuario o partes de ello sin el consentimiento previo por escrito del propietario del copyright.

# BEDIENUNGSANLEITUNG

## 1. Einführung

An alle Einwohner der Europäischen Union

### Wichtige Umweltinformationen über dieses Produkt



Dieses Symbol auf dem Produkt oder der Verpackung zeigt an, dass die Entsorgung dieses Produktes nach seinem Lebenszyklus der Umwelt Schaden zufügen kann. Entsorgen Sie die Einheit (oder verwendeten Batterien) nicht als unsortierter Hausmüll; die Einheit oder verwendeten Batterien müssen von einer spezialisierten Firma zwecks Recycling entsorgt werden. Diese Einheit muss an den Händler oder ein örtliches Recycling-Unternehmen retourniert werden. Respektieren Sie die örtlichen Umweltvorschriften.

**Falls Zweifel bestehen, wenden Sie sich für Entsorgungsrichtlinien an Ihre örtliche Behörde.**

Vielen Dank, dass Sie sich für HQPower™ entschieden haben! Lesen Sie diese Bedienungsanleitung vor Inbetriebnahme sorgfältig durch. Überprüfen Sie, ob Transportschäden vorliegen. Sollte dies der Fall sein, verwenden Sie das Gerät nicht und wenden Sie sich an Ihren Händler.

## 2. Umschreibung

1. ON/OFF-Schalter
2. Netzteil

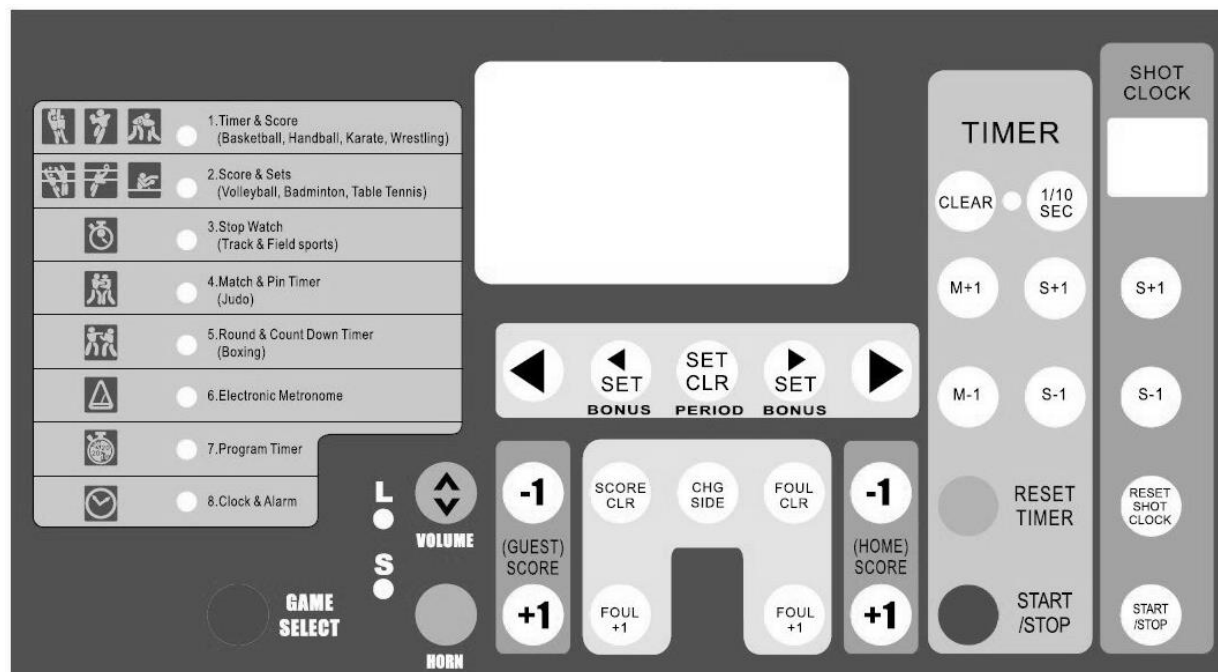
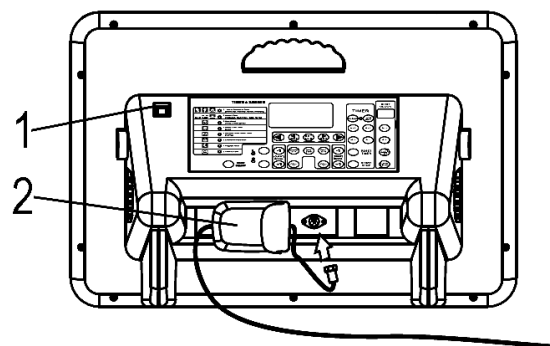

### 3. Die Anzeigetafel installieren

- Versorgen Sie die Anzeigetafel, indem Sie das Netzteil mit dem Stromversorgungseingang verbinden (siehe Abb. 1). Verbinden Sie das Netzteil mit dem Netz.
- Schalten Sie die Anzeigetafel über den EIN/AUS-Schalter ein oder aus. Nach einigen Sekunden ist die Anzeigetafel initialisiert.
- Drücken Sie **GAME SELECT** ein Mal. Die LED neben Timer & Score blinkt.
- Drücken Sie **CLEAR**. Stellen Sie den Timer danach mit **M+1/M-1** und **S+1/S-1** ein, und stellen Sie den Ballbesitztmer mit **S+1/S-1** im Shotclock-Menü ein.
- Drücken Sie **START/STOP** im Timermenü, um den Timer und den Ballbesitztmer zu starten. Drücken Sie **START/STOP** im Timermenü nach einigen Sekunden wieder.
- Drücken Sie **RESET TIMER** und **RESET SHOT CLOCK**. Die Anzeigetafel zeigt die letzt gespeicherte Anzeige an.
- Drücken Sie **GAME SELECT** um das Einstellmenü zu verlassen.

### 4. Anwendung















#### A. TIMER & SPIELSTAND (Basketball, Handball, Karate, Ringen)

Dieser Modus zeigt die verbleibende Restspielzeit und den Spielstand an.

Obere Reihe: Spieldauer (max. 99:59)

Untere Reihe: Spielstand (max. 199)

#### Countdown Timer (Rückwärtszählen)

Umschreibung	Taste		Display	Hupe
	Timer	Shot Clock		
1. Den Spielmodus wählen			<b>0:00</b> <b>0 0</b>	
2. Die letzten Einstellungen abrufen			<b>20:00</b> <b>0 0</b>	
3. Vorige Einstellungen löschen			<b>0:00</b> <b>0 0</b>	
4. Die Zeit einstellen (z.B. 20 Min.)	 		<b>20:00</b> <b>0 0</b>	
5. Den Timer für den Ballbesitz einstellen		 	<b>20:00</b> <b>0 0</b>	
6. Ballbesitztmer ist eingestellt			<b>19:59</b> <b>0 0</b>	
7. Die Periode einstellen			<b>1234</b> <b>••••</b>	
8. Der Ball trifft den Basketballring			<b>19:58</b> <b>0 0</b>	
9. Das Spiel wurde unterbrochen			<b>19:50</b> <b>0 0</b>	
10. Das Spiel & den Ballbesitztmer wieder starten			<b>19:49</b> <b>0 0</b>	
10.1. 30 Sekunden sind vorbei			<b>19:28</b> <b>0 0</b>	
10.2. 30 Sekunden rücksetzen			<b>19:28</b> <b>0 0</b>	

10.3. Das Spiel neu starten			19:27 0 0	
11. Die Spielzeit ist vorbei			0:00 0 0	
12. Ein neues Spiel einstellen			20:00 0 0	

- Der Spieltimer hat zu spät aufgehört: regeln Sie den Unterschied mit und .
- Drücken Sie um die Hupe auszulösen.

Spielstand		
Umschreibung	Taste	Display
1. <b>Gäste</b> erzielen Punkte		19:20 0 1
2. <b>Heim</b> erzielt Punkte		19:15 1 1
3. <b>Heim</b> verliert einen Punkt oder ein falsch addierter Punkt wird abgezogen		19:15 0 1
4. Den Spielstand rücksetzen		19:15 0 0

Spielerfouls		
Umschreibung	Taste	Display
1. <b>Gäste</b> macht ein Spielerfoul		19:20 0 1
2. <b>Heim</b> macht ein Spielerfoul		19:15 1 1
3. <b>Heim</b> macht ein zweites Spielerfoul		19:15 2 1
4. Rücksetzen		19:15 0 0

- Drücken Sie oder um zwischen Heim und Gast zu schalten. Drücken Sie oder für Bonuspunkte.

Count-up Timer (Vorwärtszählen)				
Umschreibung	Taste		Display	Alarm
	Timer	Shot Clock		
1. Den Spielmodus wählen			20:00 0 0	
2. Vorige Einstellungen löschen			0:00 0 0	
3. Die Anzeigetafel im Count-Up-Modus stellen			0:00 0 0	
4. Die Zeit einstellen (z.B. 20 Min.)			20:00 0 0	
5. Die letzten Einstellungen abrufen			20:00 0 0	



6. Die Spielzeit kehrt zu 0:00 zurück			0:00 0 0	
7. Das Spiel und den Ballbesitztmer wieder starten			0:01 0 0	
8. Das Spiel wurde unterbrochen			0:09 0 0	
9. Den Ballbesitztmer rücksetzen			0:09 0 0	
10. Das Spiel neu starten			0:10 0 0	
11. Den Ballbesitztmer stopfen			0:19 0 0	
12. Die Spielzeit ist vorbei			20:00 0 0	
13. Die Spielzeit rücksetzen			0:00 0 0	

- Der Spieltimer hat zu spät aufgehört: regeln Sie den Unterschied mit und .
- Drücken Sie und danach um zum Rückwärtsmodus zurückzukehren

**B. SPIELSTAND & SÄTZE** (Volleyball, Badminton, Tischtennis)

Dieser Spielmodus zeigt die gewonnenen Sätze und den Spielstand an.

Obere Reihe: Spielstand (max. 99)

Untere Reihe: Sätze (max. 199)





Spielstand / Sätze / opslag		
Umschreibung	Taste	Display
1. Den Spielmodus wählen		0 0 0 0
2. Anzeige der Aufschlagseite (Heim / Gast)		• 0 0 0 0
3. <b>Heim</b> erzielt einen Punkt		1 0 0 0
4. <b>Gäste</b> erzielen einen Punkt		1 1 0 0
5. <b>Gäste</b> gewinnen den ersten Satz		1 1 0 1
6. Die Mannschaften wechseln die Seite		1 1 1 0
7. Den Spielstand rücksetzen		0 0 0 0



- Drücken Sie um einen Punkt abzuziehen.
- Drücken Sie und geben Sie die genaue Punkteanzahl ein wenn Sie ein Spielerfoul gemacht haben.

**C. CHRONOMETER**

Obere Reihe: Minuten und Sekunden (max. 59:59)

Untere Reihe: Stunden (max. 199) und 1/100tel Sekunde (max. 99)

<b>Stoppuhr</b>		
<b>Umschreibung</b>	<b>Taste</b>	<b>Display</b>
1. Den Spielmodus wählen		<b>0:00</b> <b>00</b>
2. Die Stoppuhr starten		<b>0:00</b> <b>01</b>
3. Die Stoppuhr stoppen		<b>15:24</b> <b>2 93</b>
4. Die Stoppuhr rücksetzen		<b>0:00</b> <b>00</b>













- Drücken Sie  während die Stoppuhr läuft, um die Zeit im Display zu stoppen. Die Stoppuhr funktioniert intern aber weiter. UP blinkt im Display. Drücken Sie  um die Stoppuhr weiter im Display laufen zu lassen.

**D. WETTKAMPF- & HALTEGRIFFTIMER (Judo)**

Dieser Modus zeigt die Dauer des Wettkampfes und die vergangene Zeit des Haltegriffes.

Obere Reihe: Dauer des Wettkampfes (max. 99:59)

Untere Reihe: Zeitdauer des Haltegriffes (max. 30)

<b>Wettkampf- &amp; Haltegrifftimer</b>			
<b>Umschreibung</b>	<b>Taste</b>		<b>Display</b>
	Timer	Shot Clock	
1. Den Spielmodus wählen			<b>5:00</b> <b>30</b>
2. Die Zeit einstellen (z.B. 5 Min.)	 		<b>5:00</b> <b>30</b>
3. Die Zeitdauer des Haltegriffes speichern			<b>5:00</b> <b>0</b>
4. wenn nötig, die Zeitdauer des Haltegriffes rücksetzen		 	
5. Den Kampf starten			<b>5:00</b> <b>1</b>
6. Wenn es keinen Haltegriff gibt, pausieren und setzen Sie die Zeitdauer des Haltegriffes zurück		 + 	<b>4:53</b> <b>0</b>
7. Haltegriff			<b>4:53</b> <b>1</b>
8. Den Kampf während eines Haltegriffes stoppen, den Haltegrifftimer pausieren			<b>4:35</b> <b>12</b>
9. Den Kampf und den Haltegrifftimer wieder starten			<b>4:34</b> <b>13</b>
10. Der Judoka hat sich vom Haltegriff befreit			<b>4:25</b> <b>22</b>







↓	10.1. Nächster Haltegriff			<b>1:31</b> <b>1</b>
	10.2. 30 Sekunden sind vorbei, der Kampf wird automatisch stillgelegt. Der Alarm ertönt			<b>1:00</b> <b>30</b>
	11. Die die Dauer des Wettkampfes ist vorbei, der Alarm ertönt nicht wenn ein Judoka den anderen Judoka im Haltegriff hält			<b>0:00</b> <b>22</b>
	12. Die Dauer des Wettkampfes rücksetzen		RESET TIMER	<b>5:00</b> <b>0</b>





- Der Spieltimer hat zu spät aufgehört: regeln Sie den Unterschied mit und .
- Ein Judoka im Haltegriff hat schon ein Waza-ari (wird Ippon nach 25 Sekunden): Drücken Sie während des Haltegriffes. 25 erscheint unten links im Display und der Alarm ertönt nach 25 Sekunden. Drücken Sie erneut, um die 25 Sekunden vom Display zu löschen.
- Der Kampf endet mit einem Haltegriff (Timer zeigt während eines Haltegriffes 0:00 an): Der Kampf geht ohne Alarm weiter sodass der Haltegriff-timer nicht unterbrochen wird. Wenn der Haltegriff beendet wird, drücken Sie . Der Alarm ertönt und den Kampf wird beendet.





**E. COUNTDOWN TIMER FÜR RUNDEN & PAUSEN (Boxen)**

Dieser Spielmodus zeigt die Rundezeiten und die Rundenummer an.  
 Obere Reihe: Rundezeit (max. 99:59)  
 Untere Reihe: Rundenummer (max. 99)

Countdown Timer für Runden & Pausen				
Umschreibung	Taste		Display	Alarm
	Timer	Shot Clock		
1. Den Spielmodus wählen			<b>0:00</b> <b>0</b>	
2. Die Rundezeit einstellen (z.B. 3 Min.)			<b>3:00</b> <b>0</b>	
3. Die Zeit speichern			<b>0:00</b> <b>0</b>	
4. Die Dauer der Pause einstellen (z.B. 1 Min.)			<b>1:00</b> <b>0</b>	
5. Die Zeit speichern			<b>0:00</b> <b>0</b>	
6. Die Rundenanzahl einstellen (z.B. 3 Runden)			<b>0:00</b> <b>3</b>	
7. Zur Zeitanzeige zurückkehren			<b>3:00</b> <b>1</b>	
8. Den Kampf starten			<b>2:59</b> <b>1</b>	
9. Den Kampf unterbrechen			<b>2:35</b> <b>1</b>	
10. Den Kampf wieder starten			<b>2:34</b> <b>1</b>	
11. Ein Boxer wird niedergeschlagen			<b>1:34</b> <b>1</b>	
12. Den Kampf wieder starten			<b>1:28</b> <b>1</b>	









	12.1. Ein Boxer wird niedergeschlagen			<b>1:20</b> 1	
	12.2. 10 Sekunden sind vorbei, stoppen Sie den Countdown- und Rundentimer			<b>1:10</b> 1	
	12.3. Der Kampf ist vorbei, der Alarm ertönt			<b>1:10</b> 1	

13. Erste Runde ist vorbei			<b>0:00</b> 1	
14. Pause			<b>0:59</b> 1	
15. Ende der Pause			<b>0:00</b> 1	
16. Nächste Rundedauer und -Nummer erscheinen im Display			<b>3:00</b> 2	
17. Anzahl der eingestellten Runden sind vorbei			<b>0:00</b> 3	
18. Einen neuen Kampf starten			<b>3:00</b> 1	

- Der Wettkampftimer hat zu spät aufgehört: regeln Sie den Timer mit  und ; regeln Sie die Runde mit .
- Der Timer endet (0:00) während eines Boxers niedergeschlagen ist: der Kampf geht ohne Alarm weiter sodass die Rückzählung nicht unterbrochen wird.
- Runde-/Pausedauer ändern: drücken Sie  und setzen Sie zurück.
- In der letzten Runde wird der Pausetimer nicht mehr angezeigt.

















**F. ELEKTRONISCHES METRONOM**

Obere Reihe: Rhythmus  
 Reihe unten links: Anzahl der akustischen Signale pro Minute  
 Reihe unten rechts: Länge eines akustischen Signals

Elektronisches Metronom			
Umschreibung	Taste	Display	Alarm
Stellen Sie die Länge des akustischen Signals ein	 	<b>0</b> <b>120 6</b>	
Stellen Sie die Anzahl der akustischen Signale ein	 	<b>0</b> <b>113 6</b>	
Das Metronom starten		<b>1</b> <b>113 6</b>	
Das Metronom stoppen		<b>5</b> <b>113 6</b>	
Das Metronom rücksetzen		<b>0</b> <b>113 6</b>	

**G. PROGRAMMIERTER TIMER** (Intervalltraining)

Dieser Timer zählt zurück und zeigt max. 9 Perioden an.  
 Obere Reihe: Timer (max. 99:59)  
 Reihe unten links: Anzahl Wiederholungen (max. 9)  
 Reihe unten rechts: Programmnummer (max. 9)





Programmierter Timer			
Umschreibung	Taste	Display	Alarm
1. Die Zeit für Programm 1 einstellen (P1)		<b>5:00</b> 1 P1	
2. P1 speichern und die Zeiten für folgende Programme eingeben wenn nötig.		<b>0:00</b> 1 P2	
3. Die Programmierung vervollständigen. Die Anzahl Wiederholungen mit  vom Shot Clock einstellen. Drücken Sie  und  . Die aktuelle Runde wird angezeigt und der Timer stoppt.		<b>5:00</b> 1 P1	
4. P1 fängt mit der Rückwärtszählung an und der Alarm ertönt wenn der Timer 0:00 erreicht. Programm P2 wird gestartet. Eine Runde besteht aus dem Vollenden aller Programme.		<b>4:59</b> 1 P1	
		<b>0:00</b> 1 P2	
		<b>3:00</b> 1 P3	
		<b>0:00</b> 1 P4	
		<b>5:00</b> 1 P5	
		.	
		.	
		.	
		<b>4:59</b> 2 P1	
5. Stopp		<b>2:28</b> 9 P1	
7. Zum Anfang des Programms zurückkehren		<b>5:00</b> 0 P1	

- Die programmierten Zeiten ändern: drücken Sie  und programmieren Sie wieder.

**H. UHR & ALARM**

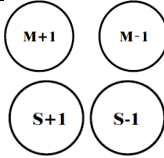
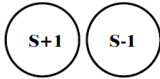
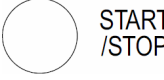

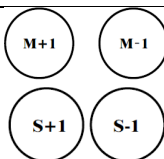
Diese Anzeigetafel zeigt die Uhr im 12-Stunden-Format an. Während der Einstellung der Uhr wird sie aber im 24-Stunden-Format angezeigt.  
 Obere Reihe: Stunden und Minuten  
 Untere Reihe: Sekunden

Uhr & Alarm			
Umschreibung	Taste		Display
	Timer	Shot Clock	
1. Die Uhr stoppen um diese einzustellen			<b>0:00</b> 00

2. Stellen Sie die Uhr und die Minuten mit den Tasten auf der unten am Timer ein. Verwenden Sie die Tasten unten am Shot Clock um die Sekunden einzustellen			<b>14:49</b> <b>13</b>
3. Bestätigen			<b>2:49</b> <b>13</b>
4. Alarmmodus			<b>12:00</b> <b>AL of</b>
5. Alarm Ein/Aus			<b>12:00</b> <b>AL on</b>
6. Stellen Sie die Alarmzeit ein			<b>13:41</b> <b>AL on</b>
7. Kehren Sie zur Zeitanzeige zurück			<b>2:51</b> <b>25</b>

- Die Anzeigetafel ertönt 5 Mal wenn die Alarmzeit erreicht ist.
- Bei Stromausfall werden die aktuelle Zeit und die Alarmzeit nicht gespeichert.

## I. ANDERE FUNKTIONEN

- Drücken Sie  um das Alarmsignal zu aktivieren.
- Regeln Sie die Lautstärke des Alarms mit .
- Drücken Sie  (wenn die LED brennt) um die letzte Minute in Sekunden anzuzeigen.

## 5. Technical Daten

Stromversorgung .....	100-240 V~, 12 VDC - 3 A
Stromverbrauch.....	< 25 W
lesbar bis max. ....	50 m
Genauigkeit.....	< 0.5 s pro Tag
Abmessungen.....	620 x 405 x 275 mm
Gewicht .....	4.75 kg

**Verwenden Sie dieses Gerät nur mit originellen Zubehörteilen. Velleman NV übernimmt keine Haftung für Schaden oder Verletzungen bei (falscher) Anwendung dieses Gerätes. Für mehr Informationen zu diesem Produkt und die neueste Version dieser Bedienungsanleitung, siehe [www.velleman.eu](http://www.velleman.eu). Alle Änderungen ohne vorherige Ankündigung vorbehalten.**

### © URHEBERRECHT

**Velleman NV besitzt das Urheberrecht für diese Bedienungsanleitung. Alle weltweiten Rechte vorbehalten.** Ohne vorherige schriftliche Genehmigung des Urhebers ist es nicht gestattet, diese Bedienungsanleitung ganz oder in Teilen zu reproduzieren, zu kopieren, zu übersetzen, zu bearbeiten oder zu speichern.

# INSTRUKCJA OBSŁUGI

## 1. Wstęp

Przeznaczona dla mieszkańców Unii Europejskiej.

**Ważne informacje dotyczące środowiska.**



Niniejszy symbol umieszczony na urządzeniu bądź opakowaniu wskazuje, że utylizacja produktu może być szkodliwa dla środowiska. Nie należy wyrzucać urządzenia (lub baterii) do zbiorczego pojemnika na odpady komunalne, należy je przekazać specjalistycznej firmie zajmującej się recyklingiem. Niniejsze urządzenie należy zwrócić dystrybutorowi lub lokalnej firmie świadczącej usługi recyklingu. Przestrzegać lokalnych zasad dotyczących środowiska

**W razie wątpliwości należy skontaktować się z lokalnym organem odpowiedzialnym za utylizację odpadów.**

Dziękujemy za zakup produktu Perel! Prosimy o dokładne zapoznanie się z instrukcją obsługi przed użyciem urządzenia. Nie montować ani nie używać urządzenia, jeśli zostało uszkodzone podczas transportu - należy skontaktować się ze sprzedawcą.

## 2. Opis

1. przełącznik on/off
2. PSU

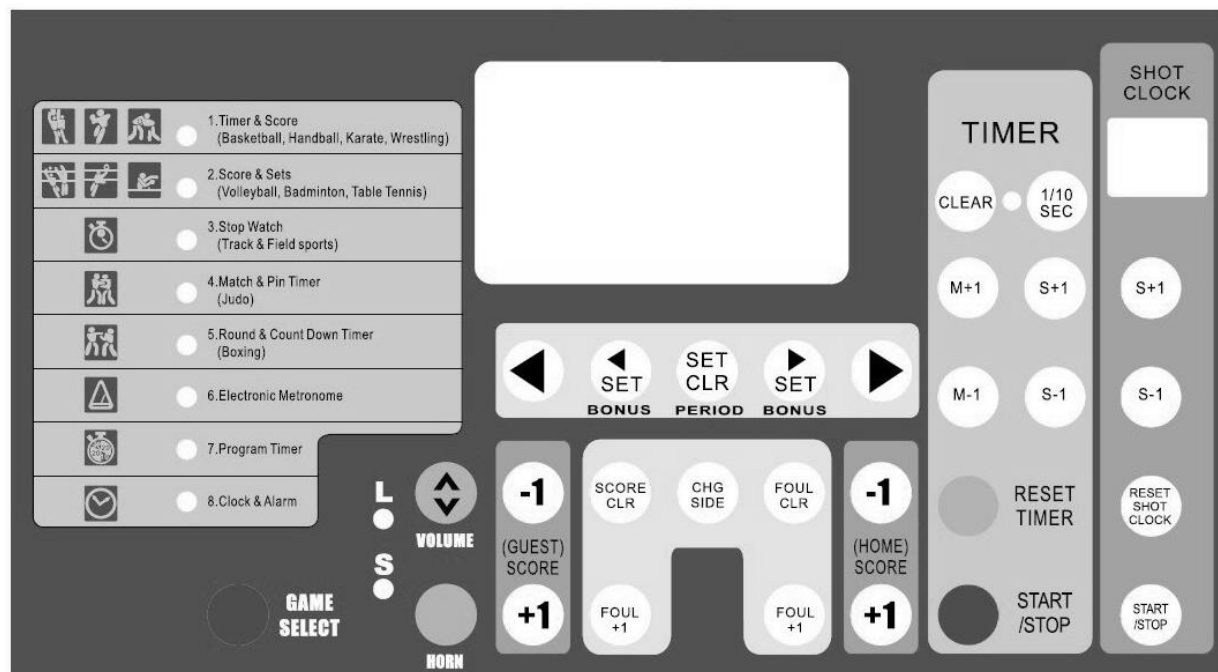
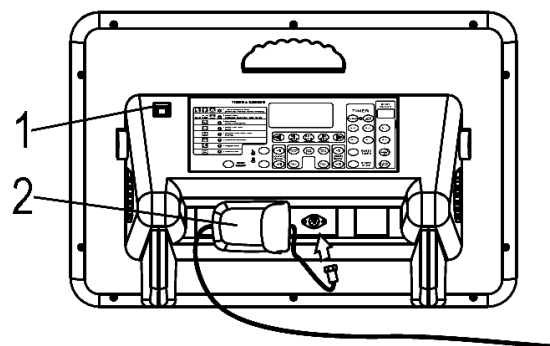

### 3. Konfiguracja tablicy wyników

- Doprowadzić zasilanie do tablicy przez podłączenie zasilacza do wejścia zasilania (patrz rys. 1). Podłączyć zasilacz do sieci.
- Włączyć tablicę wyników przełącznikiem ON/OFF. Inicjalizacja tablicy zajmie chwilę.
- Jednokrotnie nacisnąć **przycisk GAME SELECT**. Dioda LED trybu "Timer & Score" zacznie migać.
- Nacisnąć **CLEAR**. Następnie ustawić czasomierz przyciskami **M+1/M-1** i **S+1/S-1** oraz zegar 24-sekundowy przyciskami **S+1/S-1** pod panelem zegara 24-sekundowego.
- Nacisnąć przycisk **START/STOP** czasomierza, aby uruchomić czasomierz i zegar 24-sekundowy, a następnie odczekać kilka sekund. Ponownie nacisnąć przycisk **START/STOP** czasomierza.
- Nacisnąć **RESET TIMER** i **RESET SHOT CLOCK**. Na wyświetlaczu pokazane zostaną ostatnio zapamiętane dane.
- Nacisnąć **GAME SELECT**, aby wyjść z trybu konfiguracji.

### 4. Obsługa















#### A. CZAS i WYNIK (koszykówka, piłka ręczna, karate, zapasy)

W tym trybie wyświetlany jest pozostały czas meczu i jego wynik.





Górny wyświetlacz: czas meczu (maks. 99:59)



Dolny wyświetlacz: wynik (maks. 199)





#### Czasomierz meczu z funkcją odliczania wstecznego





Zastosowanie	Przycisk		Wyświetlacz	Brzęczyk
	Czasomierz	Zegar 24-sekundowy		
1. Wybór gry			<b>0:00</b> <b>0 0</b>	
2. Wywołanie ostatniej ustawionej w pamięci wartości			<b>20:00</b> <b>0 0</b>	
3. Usunięcie poprzednich ustawień			<b>0:00</b> <b>0 0</b>	
4. Ustawienie czasu meczu (np. 20 min)	 		<b>20:00</b> <b>0 0</b>	
5. Ustawienie zegara 24-sekundowego		 	<b>20:00</b> <b>0 0</b>	
6. Czas zegara 24-sekundowego zostanie zapamiętany			<b>19:59</b> <b>0 0</b>	
7. Ustawianie czasu jednej jednostki (np. kwarty)			<b>1234</b> <b>••••</b>	
8. Rzut trafił w obręcz			<b>19:58</b> <b>0 0</b>	
9. Gra przerwana			<b>19:50</b> <b>0 0</b>	
10. Wznowienie meczu i uruchomienie zegara 24-sekundowego			<b>19:49</b> <b>0 0</b>	
10,1. Upływ 30 sekund			<b>19:28</b> <b>0 0</b>	
10,2. Ponowne ustawienie 30 sekund			<b>19:28</b> <b>0 0</b>	













	10,3. Wznowienie meczu			<b>19:27</b> <b>0 0</b>	
	11. Czas meczu upłynął			<b>0:00</b> <b>0 0</b>	
	12. Zerowanie czasu gry			<b>20:00</b> <b>0 0</b>	

- Czasomierz zatrzymany zbyt późno: skorygować różnicę przyciskami  i 
- Nacisnąć , aby uruchomić brzęczyk.

Wynik		
Zastosowanie	Przycisk	Wyświetlacz
1. Drużyna <b>gości</b> zdobywa punkt		<b>19:20</b> <b>0 1</b>
2. Drużyna <b>gospodarzy</b> zdobywa punkt		<b>19:15</b> <b>1 1</b>
3. Drużyna <b>gospodarzy</b> traci punkt lub błędne zaliczenie punktu		<b>19:15</b> <b>0 1</b>
4. Zerowanie wyników		<b>19:15</b> <b>0 0</b>

Faul		
Zastosowanie	Przycisk	Wyświetlacz
1. Drużyna <b>gości</b> popełnia faul		<b>19:20</b> <b>0 1</b>
2. Drużyna <b>gospodarzy</b> popełnia faul		<b>19:15</b> <b>1 1</b>
3. Drużyna <b>gospodarzy</b> popełnia drugi faul		<b>19:15</b> <b>2 1</b>
4. Resetowanie urządzenia.		<b>19:15</b> <b>0 0</b>

- Nacisnąć  lub , aby przełączać pomiędzy drużyną gości, a drużyną gospodarzy. Nacisnąć  lub , aby przyznać punkty dodatkowe.

Czasomierz meczu z funkcją liczenia wpływającego czasu				
Zastosowanie	Przycisk		Wyświetlacz	Brzęczyk
	Czasomierz	Zegar 24-sekundowy		
1. Wybór gry			<b>20:00</b> <b>0 0</b>	
2. Usunięcie poprzednich ustawień			<b>0:00</b> <b>0 0</b>	
3. Ustawić ekran na tryb pomiaru czasu			<b>0:00</b> <b>0 0</b>	
4. Ustawienie czasu meczu (np. 20 min)	 		<b>20:00</b> <b>0 0</b>	
5. Wywołanie ostatniej ustawionej w pamięci wartości zegara 24-sekundowego			<b>20:00</b> <b>0 0</b>	

6. Czas meczu powraca do 0:00			0:00 0 0	
7. Jednoczesne rozpoczęcie meczu i uruchomienie zegara 24-sekundowego			0:01 0 0	
8. Gra przerwana			0:09 0 0	
9. Zerowanie zegara 24-sekundowego			0:09 0 0	
10. Wznowienie meczu			0:10 0 0	
11. Zatrzymanie zegara 24-sekundowego			0:19 0 0	
12. Czas meczu upłynął			20:00 0 0	
13. Zerowanie czasu gry			0:00 0 0	

- Czasomierz zatrzymany zbyt późno: skorygować różnicę przyciskami i .
- Nacisnąć , a następnie , aby powrócić do wstecznego odliczania czasu.

#### B. SCORE & SETS (siatkówka, badminton, tenis stołowy)

W tym trybie wyświetlana jest liczba wygranych setów i wynik.

Górny wyświetlacz: wynik (maks. 99)

Dolny wyświetlacz: sety (maks. 199)





Wynik / Sety / Zagrywka		
Zastosowanie	Przycisk	Wyświetlacz
1. Wybór gry		0 0 0 0
2. Zagrywka drużyny gospodarzy / gości		• 0 0 0 0
3. Drużyna <b>gospodarzy</b> zdobywa punkt		1 0 0 0
4. Drużyna <b>gości</b> zdobywa punkt		1 1 0 0
5. Drużyna <b>gości</b> wygrywa set		1 1 0 1
6. Zmiana połowy boiska		1 1 1 0
7. Zerowanie wyników		0 0 0 0



- Nacisnąć , aby odjąć punkt.
- Nacisnąć i wprowadzić dokładną liczbę setów w przypadku popełnienia błędu.

**C STOPER**

Górny wyświetlacz: minuty i sekundy (maks. 59:59)

Dolny wyświetlacz: godziny (maks. 199) i setne części sekundy (maks. 99)

Stoper		
Zastosowanie	Przycisk	Wyświetlacz
1. Wybór trybu		<b>0:00</b> <b>00</b>
2. Uruchomienie stopera		<b>0:00</b> <b>01</b>
3. Wyłączenie stopera		<b>15:24</b> <b>2 93</b>
4. Zerowanie stopera		<b>0:00</b> <b>00</b>













- Nacisnąć  podczas pracy stopera, aby zatrzymać czas na wyświetlaczu. Bieg stopera nie zostanie wówczas zatrzymany. Na ekranie będzie migać napis UP. Nacisnąć , aby kontynuować.



**D. CZAS MECZU I TRZYMANIA** (judo)





W tym trybie wyświetlany jest czas meczu i trzymania.

Górny wyświetlacz: czas meczu (maks. 99:59)

Dolny wyświetlacz: czas trzymania (maks. 30)

Czasomierz meczu i trzymania			
Zastosowanie	Przycisk		Wyświetlacz
	Czasomierz	Zegar 24-sekundowy	
1. Wybór trybu			<b>5:00</b> <b>30</b>
2. Ustawianie czasu meczu (np. 5 min)	 		<b>5:00</b> <b>30</b>
3. Zapis czasu trzymania w pamięci			<b>5:00</b> <b>0</b>
4. Zerowanie czasu trzymania w razie konieczności		 	
5. Początek meczu			<b>5:00</b> <b>1</b>
6. Jeżeli trzymanie nie rozpoczęło się, zatrzymać pomiar czasu trzymania i wyzerować go.		 + 	<b>4:53</b> <b>0</b>
7. Początek trzymania			<b>4:53</b> <b>1</b>
8. Zatrzymanie meczu podczas trzymania, wstrzymanie pomiaru czasu trzymania			<b>4:35</b> <b>12</b>
9. Wznowienie meczu, kontynuowanie pomiaru czasu trzymania			<b>4:34</b> <b>13</b>
10. Uwolnienie z trzymania			<b>4:25</b> <b>22</b>

↓	10,1. Rozpoczęcie kolejnego trzymania			<b>1:31</b> <b>1</b>
	10,2. Minęło 30 sekund, czas meczu jest automatycznie zatrzymywany, emitowany jest sygnał dźwiękowy			<b>1:00</b> <b>30</b>
	11. Upłynął czas meczu, sygnał dźwiękowy nie będzie emitowany w trakcie trzymania			<b>0:00</b> <b>22</b>
	12. Zerowanie czasu meczu		RESET TIMER	<b>5:00</b> <b>0</b>

















- Czasomierz zatrzymany zbyt późno: skorygować różnicę przyciskami  i 
- Przeciwnik trzymanego judoki otrzymał już waza-ari (zamienia się w ippon po 25 sekundach): nacisnąć  podczas odliczania trzymania. Na dolnym wyświetlaczu z lewej strony pojawi się 25, a po upływie tych 25 sekund wyemitowany zostanie sygnał dźwiękowy. Aby anulować odliczanie 25 sekund nacisnąć ponownie .
- Czas meczu osiągnie 0:00 podczas trzymania: mecz będzie kontynuowany bez emisji sygnału dźwiękowego, a odliczanie trzymania nie zostanie przerwane. Po uwolnieniu się z trzymania  wyemitowany zostanie sygnał dźwiękowy i mecz się zakończy.

### E. CZASOMIERZ ODLICZNIEM WSTECZNYM CZASU RUND I PRZERW (boks)







W tym trybie wyświetlany jest czas rundy i liczba rund.





Górny wyświetlacz: czas rundy (maks. 99:59)





Dolny wyświetlacz: liczba rund (maks. 99)

Czasomierz z odliczaniem wstecznym czasu rund i przerw				
Zastosowanie	Przycisk		Wyświetlacz	Brzęczyk
	Czasomierz	Zegar 24-skundowy		
1. Wybór gry			<b>0:00</b> <b>0</b>	
2. Ustawianie czasu rundy (np. 3 min)	 		<b>3:00</b> <b>0</b>	
3. Wprowadzenie czasu rundy do pamięci			<b>0:00</b> <b>0</b>	
4. Ustawianie czasu przerwy (np. 1 min)	 		<b>1:00</b> <b>0</b>	
5. Wprowadzenie czasu przerwy do pamięci			<b>0:00</b> <b>0</b>	
6. Ustawienie liczby rund (np. 3 rundy)	 		<b>0:00</b> <b>3</b>	
7. Powrót do wyświetlania czasu rundy			<b>3:00</b> <b>1</b>	
8. Początek meczu			<b>2:59</b> <b>1</b>	
9. Przerwanie meczu			<b>2:35</b> <b>1</b>	
10. Wznowienie meczu			<b>2:34</b> <b>1</b>	
11. Nokdaun			<b>1:34</b> <b>1</b>	

12. Mecz jest kontynuowany			<b>1:28</b> <b>1</b>	
----------------------------	--	--	-------------------------	--

12,1. Nokdaun			<b>1:20</b> <b>1</b>	
12,2. Upłynęło 10 sekund, zatrzymanie odliczania i czasomierza rundy			<b>1:10</b> <b>1</b>	
12,3. Koniec meczu, emisja sygnału dźwiękowego			<b>1:10</b> <b>1</b>	

13. Koniec pierwszej rundy			<b>0:00</b> <b>1</b>	
14. Czas przerwy			<b>0:59</b> <b>1</b>	
15. Koniec czasu przerwy			<b>0:00</b> <b>1</b>	
16. Wyświetlany jest czas i numer kolejnej rundy			<b>3:00</b> <b>2</b>	
17. Zakończono określoną liczbę rund			<b>0:00</b> <b>3</b>	
18. Rozpoczęcie nowego meczu		RESET TIMER	<b>3:00</b> <b>1</b>	









- Czasomierz zatrzymany zbyt późno: skorygować różnicę przyciskami  i ; aby skorygować różnicę w czasie rund, użyć zegara 24-sekundowego 
- Czas rundy osiąga 0:00 podczas odliczania: mecz będzie kontynuowany bez emisji sygnału dźwiękowego, a odliczanie nie zostanie przerwane.
- Modyfikacja czasu rundy/przerwy: nacisnąć  i wyzerować.
- W ostatniej rundzie czas przerwy nie będzie wyświetlany.

## F METRONOM ELEKTRONICZNY

Górny wyświetlacz: rytm

Lewy dolny wyświetlacz: liczba dźwięków na minutę

Dolny prawy wyświetlacz: długość dźwięku

Metronom elektroniczny			
Zastosowanie	Przycisk	Wyświetlacz	Brzęczyk
Ustawianie długości dźwięku	 	<b>0</b> <b>120 6</b>	
Ustawianie liczby dźwięków	 	<b>0</b> <b>113 6</b>	
Uruchomienie metronomu		<b>1</b> <b>113 6</b>	
Zatrzymanie metronomu		<b>5</b> <b>113 6</b>	
Zerowanie metronomu		<b>0</b> <b>113 6</b>	

















**G. PROGRAMOWANIE CZASOMIERZA** (trening interwałowy)

Czasomierz może być zaprogramowany do kolejnego odliczania i wyświetlania maks. 9 różnych okresów.

Górny wyświetlacz: czas (maks. 99:59)

Lewy dolny wyświetlacz: liczba powtórzeń (maks. 9)

Dolny prawy wyświetlacz: numer programu (maks. 9)

<b>Programowanie czasomierza</b>			
<b>Zastosowanie</b>	<b>Przycisk</b>	<b>Wyświetlacz</b>	<b>Brzęczyk</b>
1. Ustawić żądany czas dla programu 1 (P1)		<b>5:00</b> <b>1 P1</b>	
2. Wprowadzić P1 do pamięci, następnie wprowadzić czasy dla ewentualnych kolejnych programów		<b>0:00</b> <b>1 P2</b>	
3. Uzupełnić ustawienia programu. Ustawić wymaganą liczbę powtórzeń za pomocą zegara 24-sekundowego  . Nacisnąć  i  . Wyświetli się bieżąca runda, a czasomierz zatrzyma się.		<b>5:00</b> <b>1 P1</b>	
4. Rozpocznie się odliczanie P1, po osiągnięciu 0:00 zostanie wyemitowany sygnał dźwiękowy. Następnie, rozpocznie się P2. Za jedną rundę uważane jest ukończenie wszystkich programów.		<b>4:59</b> <b>1 P1</b>	
		<b>0:00</b> <b>1 P2</b>	
		<b>3:00</b> <b>1 P3</b>	
		<b>0:00</b> <b>1 P4</b>	
		<b>5:00</b> <b>1 P5</b>	
		<b>4:59</b> <b>2 P1</b>	
5. Zatrzymanie		<b>2:28</b> <b>9 P1</b>	
7. Powrót do początku programu		<b>5:00</b> <b>0 P1</b>	

- Zmiana ustawionych czasów: Nacisnąć  i wyzerować czasomierze.







**H. ZEGAR i ALARM**

Tablica wyników wyświetla czas w formacie 12h, ale podczas edycji wyświetlanie odbywa się w formacie 24h.

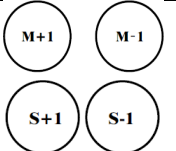
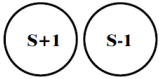
Górny wyświetlacz: godziny i minuty

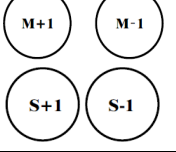

Dolny prawy wyświetlacz: sekundy

<b>Zegar i alarm</b>			
<b>Zastosowanie</b>	<b>Przycisk</b>		<b>Wyświetlacz</b>
	Czasomierz	Zegar 24-sekundowy	
1. Zatrzymać zegar, aby ustawić czas			<b>0:00</b> <b>00</b>

2. Ustawić czas, do ustawienia godzin i minut użyć przycisków czasomierza, do ustawienia sekund użyć przycisków zegara 24-sekundowego			<b>14:49</b> <b>13</b>
3. Zatwierdzić czas			<b>2:49</b> <b>13</b>
4. Tryb alarmu			<b>12:00</b> <b>AL of</b>
5. Alarm włączony/wyłączony			<b>12:00</b> <b>AL on</b>
6. Ustawić godzinę alarmu			<b>13:41</b> <b>AL on</b>
7. Powrócić do wyświetlania czasu			<b>2:51</b> <b>25</b>

- Po osiągnięciu czasu alarmu tablica wyników wyemituje 5-sekundowy sygnał dźwiękowy.
- W przypadku przerwy w zasilaniu, bieżąca godzina i godzina alarmu nie zostaną zapamiętane.

## I. INNE INSTRUKCJE

- W dowolnym momencie można nacisnąć , aby uruchomić brzęczyk.
- Jego głośność można ustawić za pomocą .
- Nacisnąć  (gdy zapali się dioda LED), aby wyświetlić ostatnią minutę w postaci sekund.

## 5. Specyfikacja techniczna

zasilanie .....	100-240 V~, 12 VDC - 3 A
pobór mocy .....	< 25 W
maks. odległość widzenia .....	50 m
dokładność czasu .....	< 0.5 s per day
wymiary .....	620 x 405 x 275 mm
waga .....	4.75 kg

**Należy używać wyłącznie oryginalnych akcesoriów. Firma Velleman nv nie ponosi odpowiedzialności za uszkodzenia lub urazy wynikające z (niewłaściwego) korzystania z niniejszego urządzenia. Aby uzyskać więcej informacji dotyczących produktu oraz najnowszą wersję niniejszej instrukcji, należy odwiedzić naszą stronę internetową [www.velleman.eu](http://www.velleman.eu). Informacje zawarte w niniejszej instrukcji obsługi mogą ulec zmianie bez wcześniejszego powiadomienia.**

### © INFORMACJA O PRAWACH AUTORSKICH

**Właścicielem praw autorskich do niniejszej instrukcji jest firma Velleman nv. Wszelkie prawa są zastrzeżone na całym świecie.** Żadna część niniejszej instrukcji nie może być kopiowana, powielana, tłumaczona ani przenoszona na jakikolwiek nośnik elektroniczny (lub w inny sposób) bez wcześniejszej pisemnej zgody właściciela praw autorskich.

# MANUAL DO UTILIZADOR

## 1. Introdução

### Aos cidadãos da União Europeia

#### Importantes informações sobre o meio ambiente no que respeita a este produto



Este símbolo no aparelho ou na embalagem indica que, enquanto desperdícios, poderão causar danos no meio ambiente. Não coloque a unidade (ou as pilhas) no depósito de lixo municipal; deve dirigir-se a uma empresa especializada em reciclagem. Devolva o aparelho ao seu distribuidor ou ao posto de reciclagem local. Respeite a legislação local relativa ao meio ambiente.

**Em caso de dúvidas, contacte com as autoridades locais para os resíduos.**

Agradecemos o facto de ter escolhido a Perel! Leia atentamente as instruções do manual antes de usar o aparelho. Caso o aparelho tenha sofrido algum dano durante o transporte não o instale e entre em contacto com o seu distribuidor.

## 2. descrição

1. microfone
2. unidade de Alimentação

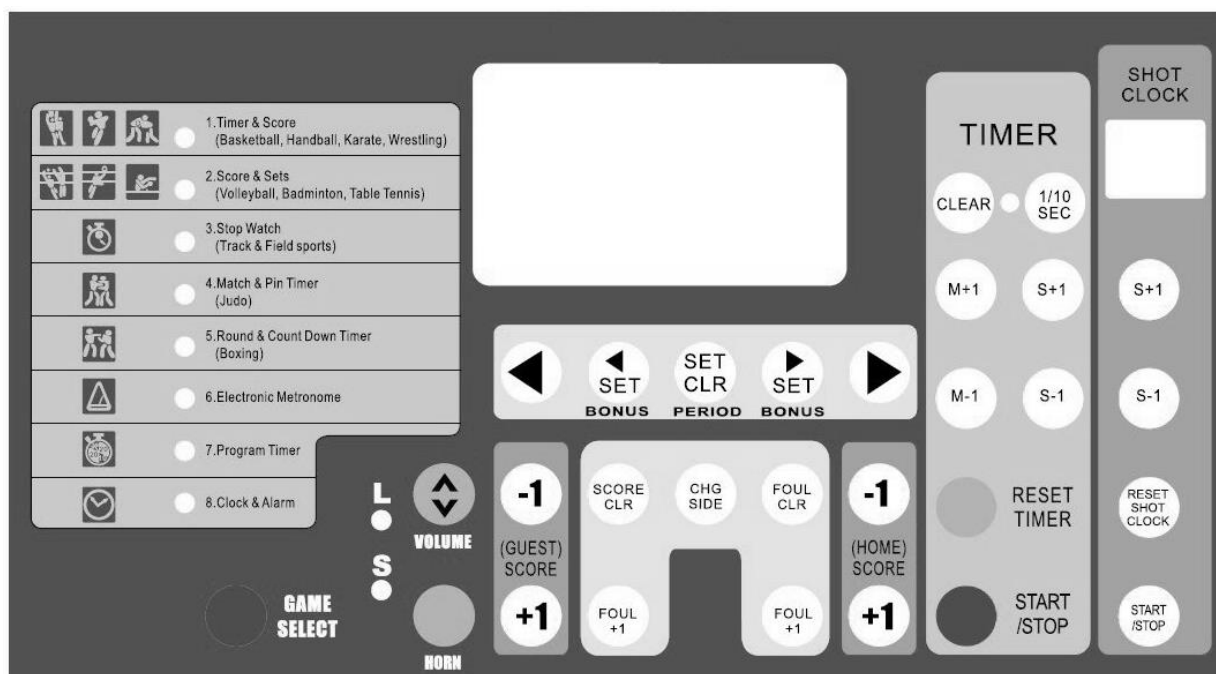
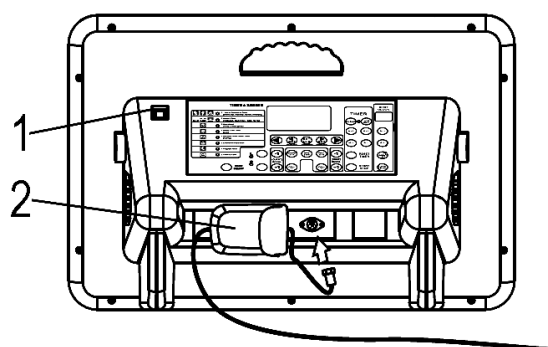



### 3. Instalar o Marcador Desportivo

- Ligue o painel à corrente conectando a unidade de alimentação na respetiva entrada. 1). Ligue o recetor à tomada de corrente elétrica.
- Ligue o marcador desportivo usando o interruptor ON/OFF. Demora alguns segundos até o painel inicializar.
- Pressione **GAME SELECT** uma vez. O LED junto ao cronómetro e marcador fica intermitente.
- Pressione **CLEAR**. Em seguida, escolha o temporizador desejado usando **M+1/M-1** e **S+1/S-1**, e ajuste o cronómetro **S+1/S-1** no respetivo painel.
- Pressione o botão **START/STOP** do temporizador para iniciar o temporizador e o cronómetro, e deixe contar durante alguns segundos. Pressione o botão **START/STOP** do temporizador novamente.
- Pressione **RESET TIMER** e **RESET SHOT CLOCK**. O visor apresentará os últimos dados gravador.
- Pressione **GAME SELECT** para sair do modo de configuração.















### 4. Utilização





#### A. CRONÓMETRO & MARCADOR DE PONTUAÇÃO (basquetebol, andebol, karate, luta livre)



Neste é apresentado o tempo restante de jogo e a pontuação.





Na parte superior: tempo de jogo (máx. 99:59)





Na parte inferior: pontuação (máx. 199)





Temporizador de Contagem Decrescente				
Utilização	Tecla		Visualização	sirene
	Temporizador	Cronómetro		
1. Selecionar modo			<b>0:00</b> <b>0 0</b>	
2. Apresentar dados memorizados			<b>20:00</b> <b>0 0</b>	
3. Apagar as últimas configurações			<b>0:00</b> <b>0 0</b>	
4. Definir tempo de jogo (por ex. 20 minutos)	 		<b>20:00</b> <b>0 0</b>	
5. Configurar cronómetro		 	<b>20:00</b> <b>0 0</b>	
6. O tempo do cronómetro é memorizado			<b>19:59</b> <b>0 0</b>	
7. Definir período			<b>1234</b> <b>••••</b>	
8. A bola bate no aro			<b>19:58</b> <b>0 0</b>	
9. Jogo interrompido			<b>19:50</b> <b>0 0</b>	
10. Reiniciar jogo & reiniciar cronómetro			<b>19:49</b> <b>0 0</b>	
10,1. Os 30 segundos expiram			<b>19:28</b> <b>0 0</b>	
10,2. Reiniciar os 30 segundos			<b>19:28</b> <b>0 0</b>	







10,3. Reiniciar jogo			<b>19:27</b> <b>0 0</b>	
11. Expira o tempo de jogo			<b>0:00</b> <b>0 0</b>	
12. Reiniciar o tempo de jogo			<b>20:00</b> <b>0 0</b>	

- O temporizador do jogo parou demasiado tarde: utilização  coloridos  ajustar a diferença
- Pressionar  para soar a campainha.





Pontuação		
Utilização	Tecla	Visualização
1. <b>A equipa</b> visitante marca		<b>19:20</b> <b>0 1</b>
2. <b>A equipa</b> da casa marca		<b>19:15</b> <b>1 1</b>
3. <b>A equipa da casa</b> perde pontos ou são acrescentados pontos por engano		<b>19:15</b> <b>0 1</b>
4. Limpar pontuação		<b>19:15</b> <b>0 0</b>

Falta		
Utilização	Tecla	Visualização
1. <b>A equipa</b> visitante comete uma falta		<b>19:20</b> <b>0 1</b>
2. <b>A equipa</b> da casa comete uma falta		<b>19:15</b> <b>1 1</b>
3. <b>A equipa</b> da casa comete uma segunda falta		<b>19:15</b> <b>2 1</b>
4. Reinicializar		<b>19:15</b> <b>0 0</b>

- Pressionar  ou  para alternar entre a equipa da casa e a equipa visitante Pressionar  ou  para atribuir pontos extra

Temporizador de Contagem Crescente				
Utilização	Tecla		Visualização	sirene
	Temporizador	Cronómetro		
1. Selecionar modo			<b>20:00</b> <b>0 0</b>	
2. Eliminar configurações anteriores			<b>0:00</b> <b>0 0</b>	
3. Configurar exibição para o modo crono			<b>0:00</b> <b>0 0</b>	
4. Definir tempo de jogo (por ex. 20 minutos)	 		<b>20:00</b> <b>0 0</b>	
5. Recuperar memória do cronómetro			<b>20:00</b> <b>0 0</b>	

6. O tempo de jogo volta a 0:00			<b>0:00</b> <b>0 0</b>	
7. Iniciar jogo & cronómetro simultaneamente			<b>0:01</b> <b>0 0</b>	
8. Jogo interrompido			<b>0:09</b> <b>0 0</b>	
9. Reiniciar o cronómetro			<b>0:09</b> <b>0 0</b>	
10. Reiniciar jogo			<b>0:10</b> <b>0 0</b>	
11. Parar cronómetro			<b>0:19</b> <b>0 0</b>	
12. Termina o tempo de jogo			<b>20:00</b> <b>0 0</b>	
13. Reiniciar tempo de jogo			<b>0:00</b> <b>0 0</b>	







- O temporizador parou demasiado tarde: utilização  coloridos  para ajustar a diferença
- Pressionar  e depois  para regressar ao temporizador de contagem decrescente



## B. PONTUAÇÃO & PARTIDAS (voleibol, badminton, ténis de mesa)

Neste modo são apresentadas as partidas ganhas e a pontuação.

Na parte de cima: pontuação (máx. 99)

Na parte inferior: partidas (máx. 199)





Pontuação / Partidas / Serviço		
Utilização	Tecla	Visualização
1. Selecionar modo		<b>0 0</b> <b>0 0</b>
2. Equipe da casa/visitante ganha o serviço	 	<b>• 0 0</b> <b>0 0</b>
3. <b>Equipa</b> da casa pontua		<b>1 0</b> <b>0 0</b>
4. <b>Equipa</b> visitante pontua		<b>1 1</b> <b>0 0</b>
5. <b>Equipa</b> visitante ganha a partida		<b>1 1</b> <b>0 1</b>
6. Mudar de campo		<b>1 1</b> <b>1 0</b>
7. Limpar pontuações		<b>0 0</b> <b>0 0</b>



- Pressionar  retirar um ponto.
- Pressionar  e adicionar as partidas corretas em caso de erro.

### C. cronómetro

Na parte superior: minutos e segundos (máx. 59:59)

Na parte inferior: horas (máx. 199) e 1/100 de segundo (máx. 99)

cronómetro		
Utilização	Tecla	Visualização
1. Selecionar - modo		<b>0:00</b> <b>00</b>
2. Iniciar cronómetro		<b>0:00</b> <b>01</b>
3. Parar cronómetro		<b>15:24</b> <b>2 93</b>
4. Reinicializar cronómetro		<b>0:00</b> <b>00</b>













- Pressionar  enquanto o cronómetro está a funcionar para parar o cronómetro no ecrã principal. O cronómetro continua a funcionar internamente. "UP" pisca no ecrã. Pressionar  para continuar.



### D. TEMPORIZADOR DE COMBATE & TEMPO DE IMOBILIZAÇÃO (judo)





Este modo apresenta o tempo de combate e o tempo decorrido durante uma imobilização no solo.

Na parte superior: tempo de combate (máx. 99:59)

Na parte inferior: tempo de imobilização (máx. 30)

Temporizador de Combate & Tempo de Imobilização			
Utilização	Tecla		Visualização
	Temporizador	Cronómetro	
1. Selecionar - modo			<b>5:00</b> <b>30</b>
2. Definir tempo de combate (por ex. 5 min)	 		<b>5:00</b> <b>30</b>
3. Memorizar o tempo de imobilização			<b>5:00</b> <b>0</b>
4. Limpar o tempo de imobilização se necessário		 	
5. Iniciar combate			<b>5:00</b> <b>1</b>
6. Se a imobilização não for iniciada, suspender o tempo (pausa) e reiniciar		 + 	<b>4:53</b> <b>0</b>
7. Início da imobilização			<b>4:53</b> <b>1</b>
8. Parar o combate durante a imobilização, suspender a contagem do tempo			<b>4:35</b> <b>12</b>
9. Reiniciar o combate, retomar a contagem do tempo			<b>4:34</b> <b>13</b>
10. O judoca imobilizado liberta-se			<b>4:25</b> <b>22</b>

↓	10,1. Nova imobilização			<b>1:31</b> <b>1</b>
	10,2. após 30 segundos, o combate termina automaticamente e ouve-se a campainha			<b>1:00</b> <b>30</b>
	11. O tempo de jogo expirou, no entanto, a campainha não toca se houver imobilização no solo			<b>0:00</b> <b>22</b>
	12. Reiniciar o tempo de combate		RESET TIMER	<b>5:00</b> <b>0</b>

- O temporizador parou demasiado tarde: utilização  para ajustar a diferença.
- O judoca imobilizado já possui waza-ari (torna-se ippon após 25 segundos): Pressionar  durante a contagem decrescente para imobilização no solo. aparece "25" no canto inferior esquerdo e a campainha toca após os 25 segundos terem terminado. Pressionar  novamente para cancelar a visualização dos 25 segundos.
- O tempo de combate chega a 0.00 durante uma imobilização: o combate continua sem a campainha tocar de modo a que a contagem da imobilização não seja interrompida. Assim que a imobilização terminar, pressione . A campainha toca e o combate termina.

















### E. TEMPORIZADOR DE ROUND & PAUSA (boxe)

Neste modo é apresentado o tempo e o número do round.

Na parte superior: tempo do round (máx. 99:59)

Na parte inferior: número do round (máx. 99)

#### Temporizador de Contagem Decrescente para Round & Pausa

Utilização	Tecla		Visualização	sirene
	Temporizador	Cronómetro		
1. Selecionar modo			<b>0:00</b> <b>0</b>	
2. Definir o tempo do round (por ex. 3 minutos)	 		<b>3:00</b> <b>0</b>	
3. Memorizar tempo do round		RESET TIMER	<b>0:00</b> <b>0</b>	
4. Definir tempo de pausa (por ex. 1 min)	 		<b>1:00</b> <b>0</b>	
5. Memorizar o tempo de pausa		RESET TIMER	<b>0:00</b> <b>0</b>	
6. Definir o número de rounds (por ex. 3 rounds)	 		<b>0:00</b> <b>3</b>	
7. Voltar à exibição do tempo de round		RESET TIMER	<b>3:00</b> <b>1</b>	
8. Iniciar combate		START /STOP	<b>2:59</b> <b>1</b>	
9. Interromper combate		START /STOP	<b>2:35</b> <b>1</b>	
10. Reiniciar combate		START /STOP	<b>2:34</b> <b>1</b>	
11. Knockdown			<b>1:34</b> <b>1</b>	

12. Combate prossegue			<b>1:28</b> <b>1</b>	
-----------------------	--	--	-------------------------	--

12,1. Knockdown			<b>1:20</b> <b>1</b>	
12,2. após expirarem os 10 segundos, parar a contagem decrescente e o temporizador do round			<b>1:10</b> <b>1</b>	
12,3. Termina o combate, toca a campainha			<b>1:10</b> <b>1</b>	

13. Primeiro round completo			<b>0:00</b> <b>1</b>	
14. Pausa			<b>0:59</b> <b>1</b>	
15. A pausa termina			<b>0:00</b> <b>1</b>	
16. São exibidos o tempo e o número do próximo round			<b>3:00</b> <b>2</b>	
17. O número total de rounds foi completado			<b>0:00</b> <b>3</b>	
18. Começa um novo combate			<b>3:00</b> <b>1</b>	

- O temporizador parou demasiado tarde: utilização coloridos para ajustar a diferença; usar cronómetro para ajudar a diferença do round.
- O tempo do round chega aos 0:00 durante a contagem decrescente: o combate prossegue sem a campainha tocar de modo a que a contagem decrescente não seja interrompida.
- Alterar os tempos de round/pausa: Pressionar e eliminar.
- No último round, o tempo de pausa não será exibido.

## F. METRÓNOMO ELETRÓNICO

Na parte superior: ritmo

Na parte inferior: número de batidas por minuto

Na parte inferior: comprimento de uma batida

Metronomo Eletrónico			
Utilização	Tecla	Visualização	sirene
Definir comprimento da batida		<b>0</b> <b>120</b> <b>6</b>	
Definir número de batidas		<b>0</b> <b>113</b> <b>6</b>	
Iniciar o metrónomo		<b>1</b> <b>113</b> <b>6</b>	
Parar o metrónomo		<b>5</b> <b>113</b> <b>6</b>	
Reiniciar o metrónomo		<b>0</b> <b>113</b> <b>6</b>	

















**G. TEMPORIZADOR PROGRAMADO** (treino com intervalos)

O temporizador pode ser programado para a contagem decrescente consecutiva e exibir no máx. 9 períodos de tempo

Parte superior: temporizador (máx. 99:59)

Parte inferior: número de repetições (máx. 9)

Canto inferior direito: número do programa (máx. 9)

<b>Temporizador do Programa</b>			
<b>Utilização</b>	<b>Tecla</b>	<b>Visualização</b>	<b>sirene</b>
1. Defina o tempo para o programa 1 (P1)		<b>5:00</b> <b>1 P1</b>	
2. Introduza P1 na memória e digite os tempos para os programas seguintes, se desejar		<b>0:00</b> <b>1 P2</b>	
3. Concluir a programação Definir o número de repetições pretendido usando o cronómetro  . Pressionar  coloridos  . A série atual é apresentada e o cronómetro para.		<b>5:00</b> <b>1 P1</b>	
4. O programa P1 inicia a contagem decrescente e ouve-se o sinal sonoro a atingir 0:00. O programa P2 será iniciado posteriormente. A conclusão de todos os programas é considerada uma série.		<b>4:59</b> <b>1 P1</b>	
		<b>0:00</b> <b>1 P2</b>	
		<b>3:00</b> <b>1 P3</b>	
		<b>0:00</b> <b>1 P4</b>	
		<b>5:00</b> <b>1 P5</b>	
		<b>4:59</b> <b>2 P1</b>	
5. Stop		<b>2:28</b> <b>9 P1</b>	
7. Voltar o início do programa		<b>5:00</b> <b>0 P1</b>	

- Alterar os tempos definidos: Pressionar  e reiniciar o temporizador

**H. RELÓGIO & ALARME**

O marcador exibe as horas no formato 12h mas exibe as horas no formato 24h durante a configuração.

Na parte superior: horas e minutos

Na parte inferior: segundos

<b>Relógio &amp; Alarme</b>			
<b>Utilização</b>	<b>Tecla</b>		<b>Visualização</b>
	Temporizador	Cronómetro	
1. Para o relógio para acertar a hora			<b>0:00</b> <b>00</b>

2. Acerte a hora, use os botões do temporizador para acertar as horas e os minutos, use os botões do cronómetro para acertar os segundos			<b>14:49</b> <b>13</b>
3. Hora atual			<b>2:49</b> <b>13</b>
4. Modo Alarme			<b>12:00</b> <b>AL of</b>
5. Ligar/Desligar Alarme			<b>12:00</b> <b>AL on</b>
6. Defina a hora do alarme			<b>13:41</b> <b>AL on</b>
7. Voltar à visualização da hora			<b>2:51</b> <b>25</b>

- O marcador desportivo tocará durante 5 segundos assim que atingir a hora definida para o alarme.
- A hora atual e a hora do alarme não serão memorizadas em caso de falha de energia.

## I. OUTRAS FUNÇÕES

- Pressionar ativar o sinal sonoro a qualquer altura.
- Regular o volume do sinal sonoro usando .
- Pressionar (com o LED aceso) para exibir o minuto final em segundos

## 5. Especificações

alimentação .....	100-240 V~, 12 VDC - 3 A
consumo .....	< 25 W
distância máxima para visualização .....	50 m
precisão do tempo.....	< 0.5 s por dia
dimensões.....	620 x 405 x 275 mm
peso .....	4.75 kg

**Utilize este aparelho apenas com acessórios originais. A Velleman NV não será responsável por quaisquer danos ou lesões causados pelo uso (indevido) do aparelho. Para mais informação sobre este produto e para aceder à versão mais recente deste manual do utilizador, visite a nossa página [www.velleman.eu](http://www.velleman.eu). Podem alterar-se as especificações e o conteúdo deste manual sem aviso prévio.**

### © DIREITOS DE AUTOR

**A Velleman NV detém os direitos de autor deste manual do utilizador. Todos os direitos mundiais reservados.** Nenhuma parte deste manual pode ser copiada, reproduzida, traduzida ou resumida por qualquer eletrónica, ou de outra forma, sem prévio consentimento por parte da detentora dos direitos de autor.



**EN****Velleman® Service and Quality Warranty**

Since its foundation in 1972, Velleman® acquired extensive experience in the electronics world and currently distributes its products in over 85 countries.

All our products fulfil strict quality requirements and legal stipulations in the EU. In order to ensure the quality, our products regularly go through an extra quality check, both by an internal quality department and by specialized external organisations. If, all precautionary measures notwithstanding, problems should occur, please make appeal to our warranty (see guarantee conditions).

**General Warranty Conditions Concerning Consumer Products (for EU):**

- All consumer products are subject to a 24-month warranty on production flaws and defective material as from the original date of purchase.
- Velleman® can decide to replace an article with an equivalent article, or to refund the retail value totally or partially when the complaint is valid and a free repair or replacement of the article is impossible, or if the expenses are out of proportion.

You will be delivered a replacing article or a refund at the value of 100% of the purchase price in case of a flaw occurred in the first year after the date of purchase and delivery, or a replacing article at 50% of the purchase price or a refund at the value of 50% of the retail value in case of a flaw occurred in the second year after the date of purchase and delivery.

**• Not covered by warranty:**

- all direct or indirect damage caused after delivery to the article (e.g. by oxidation, shocks, falls, dust, dirt, humidity...), and by the article, as well as its contents (e.g. data loss), compensation for loss of profits;
- consumable goods, parts or accessories that are subject to an aging process during normal use, such as batteries (rechargeable, non-rechargeable, built-in or replaceable), lamps, rubber parts, drive belts... (unlimited list);
- flaws resulting from fire, water damage, lightning, accident, natural disaster, etc....;
- flaws caused deliberately, negligently or resulting from improper handling, negligent maintenance, abusive use or use contrary to the manufacturer's instructions;
- damage caused by a commercial, professional or collective use of the article (the warranty validity will be reduced to six (6) months when the article is used professionally);
- damage resulting from an inappropriate packing and shipping of the article;
- all damage caused by modification, repair or alteration performed by a third party without written permission by Velleman®.
- Articles to be repaired must be delivered to your Velleman® dealer, solidly packed (preferably in the original packaging), and be completed with the original receipt of purchase and a clear flaw description.
- Hint: In order to save on cost and time, please reread the manual and check if the flaw is caused by obvious causes prior to presenting the article for repair. Note that returning a non-defective article can also involve handling costs.
- Repairs occurring after warranty expiration are subject to shipping costs.
- The above conditions are without prejudice to all commercial warranties.

**The above enumeration is subject to modification according to the article (see article's manual).**

**NL****Velleman® service- en kwaliteitsgarantie**

Velleman® heeft sinds zijn oprichting in 1972 een ruime ervaring opgebouwd in de elektronica wereld en verdeelt op dit moment producten in meer dan 85 landen. Al onze producten beantwoorden aan strikte kwaliteitseisen en aan de wettelijke bepalingen geldig in de EU. Om de kwaliteit te waarborgen, ondergaan onze producten op regelmatige tijdstippen een extra kwaliteitscontrole, zowel door onze eigen kwaliteitsafdeling als door externe gespecialiseerde organisaties. Mocht er ondanks deze voorzorgen toch een probleem optreden, dan kunt u steeds een beroep doen op onze waarborg (zie waarborgvoorwaarden).

**Algemene waarborgvoorwaarden consumentengoederen (voor Europese Unie):**

- Op alle consumentengoederen geldt een garantieperiode van 24 maanden op productie- en materiaalfouten en dit vanaf de oorspronkelijke aankoopdatum.
- Indien de klacht gegrond is en een gratis reparatie of vervanging van een artikel onmogelijk is of indien de kosten hiervoor buiten verhouding zijn, kan Velleman® beslissen het desbetreffende artikel te vervangen door een gelijkwaardig artikel of de aankoopsom van het artikel gedeeltelijk of volledig terug te betalen. In dat geval krijgt u een vervangend product of terugbetaling ter waarde van 100% van de aankoopsom bij ontdekking van een gebrek tot één jaar na aankoop en levering, of een vervangend product tegen 50% van de kostprijs of terugbetaling van 50 % bij ontdekking na één jaar tot 2 jaar.

**• Valt niet onder waarborg:**

- alle rechtstreekse of onrechtstreekse schade na de levering veroorzaakt aan het toestel (bv. door oxidatie, schokken, val, stof, vuil, vocht...), en door het toestel, alsook zijn inhoud (bv. verlies van data), vergoeding voor eventuele winstderving.
- verbruiksgoederen, onderdelen of hulpstukken die onderhevig zijn aan veroudering door normaal gebruik zoals bv. batterijen (zowel oplaadbare als niet-oplaadbare, gebouwd of vervangbaar), lampen, rubberen onderdelen, aandrijfriemen... (onbepaalde lijst).
- defecten ten gevolge van brand, waterschade, bliksem, ongevallen, natuurrampen, enz.
- defecten veroorzaakt door opzet, nalatigheid of door een onoordeelkundige behandeling, slecht onderhoud of abnormaal

gebruik of gebruik van het toestel strijdig met de voorschriften van de fabrikant.

- schade ten gevolge van een commercieel, professioneel of collectief gebruik van het apparaat (bij professioneel gebruik wordt de garantieperiode herleid tot 6 maanden).
  - schade veroorzaakt door onvoldoende bescherming bij transport van het apparaat.
  - alle schade door wijzigingen, reparaties of modificaties uitgevoerd door derden zonder toestemming van Velleman®.
  - Toestellen dienen ter reparatie aangeboden te worden bij uw Velleman®-verdelers. Het toestel dient verzegeld te zijn van het oorspronkelijke aankoopbewijs. Zorg voor een degelijke verpakking (bij voorkeur de originele verpakking) en voeg een duidelijke foutomschrijving bij.
  - Tip: alvorens het toestel voor reparatie aan te bieden, kijk nog eens na of er geen voor de hand liggende reden is waarom het toestel niet naar behoren werkt (zie handleiding). Op deze wijze kunt u kosten en tijd besparen. Denk eraan dat er ook voor niet-defecte toestellen een kost voor controle aangerekend kan worden.
  - Bij reparaties buiten de waarborgperiode zullen transportkosten aangerekend worden.
  - Elke commerciële garantie laat deze rechten onverminderd.
- Bovenstaande opsomming kan eventueel aangepast worden naargelang de aard van het product (zie handleiding van het betreffende product).**

**FR****Garantie de service et de qualité Velleman®**

Depuis 1972, Velleman® a gagné une vaste expérience dans le secteur de l'électronique et est actuellement distributeur dans plus de 85 pays.

Tous nos produits répondent à des exigences de qualité rigoureuses et à des dispositions légales en vigueur dans l'UE. Afin de garantir la qualité, nous soumettons régulièrement nos produits à des contrôles de qualité supplémentaires, tant par notre propre service qualité que par un service qualité externe. Dans le cas improbable d'un défaut malgré toutes les précautions, il est possible d'invoquer notre garantie (voir les conditions de garantie).

**Conditions générales concernant la garantie sur les produits grand public (pour l'UE) :**

- tout produit grand public est garanti 24 mois contre tout vice de production ou de matériaux à dater du jour d'acquisition effective ;
- si la plainte est justifiée et que la réparation ou le remplacement d'un article est jugé impossible, ou lorsque les coûts s'avèrent disproportionnés, Velleman® s'autorise à remplacer ledit article par un article équivalent ou à rembourser la totalité ou une partie du prix d'achat. Le cas échéant, il vous sera consenti un article de remplacement ou le remboursement complet du prix d'achat lors d'un défaut dans un délai de 1 an après l'achat et la livraison, ou un article de remplacement moyennant 50% du prix d'achat ou le remboursement de 50% du prix d'achat lors d'un défaut après 1 à 2 ans.
- sont par conséquent exclus :
  - tout dommage direct ou indirect survenu à l'article après livraison (p.ex. dommage lié à l'oxydation, choc, chute, poussière, sable, impureté...) et provoqué par l'appareil, ainsi que son contenu (p.ex. perte de données) et une indemnisation éventuelle pour perte de revenus ;
  - toute pièce ou accessoire nécessitant un remplacement causé par un usage normal comme p.ex. piles (rechargeables comme non rechargeables, intégrées ou remplaçables), ampoules, pièces en caoutchouc, courroies... (liste illimitée) ;
  - tout dommage qui résulte d'un incendie, de la foudre, d'un accident, d'une catastrophe naturelle, etc. ;
  - tout dommage provoqué par une négligence, volontaire ou non, une utilisation ou un entretien incorrect, ou une utilisation de l'appareil contraire aux prescriptions du fabricant ;
  - tout dommage à cause d'une utilisation commerciale, professionnelle ou collective de l'appareil (la période de garantie sera réduite à 6 mois lors d'une utilisation professionnelle) ;
  - tout dommage à l'appareil qui résulte d'une utilisation incorrecte ou différente que celle pour laquelle il a été initialement prévu comme décrit dans la notice ;
  - tout dommage engendré par un retour de l'appareil emballé dans un conditionnement non ou insuffisamment protégé.
- toute réparation ou modification effectuée par une tierce personne sans l'autorisation explicite de SA Velleman® ; - frais de transport de et vers Velleman® si l'appareil n'est plus couvert sous la garantie.
- toute réparation sera fournie par l'endroit de l'achat. L'appareil doit nécessairement être accompagné du bon d'achat d'origine et être dûment conditionné (de préférence dans l'emballage d'origine avec mention du défaut) ;
- tuyau : il est conseillé de consulter la notice et de contrôler câbles, piles, etc. avant de retourner l'appareil. Un appareil retourné jugé défectueux qui s'avère en bon état de marche pourra faire l'objet d'une note de frais à charge du consommateur ;
- une réparation effectuée en-dehors de la période de garantie fera l'objet de frais de transport ;
- toute garantie commerciale ne porte pas atteinte aux conditions susmentionnées.

**La liste susmentionnée peut être sujette à une complémentarité selon le type de l'article et être mentionnée dans la notice d'emploi.**

**ES****Garantía de servicio y calidad Velleman®**

Desde su fundación en 1972 Velleman® ha adquirido una amplia experiencia como distribuidor en el sector de la electrónica en más de 85 países. Todos nuestros productos responden a normas de calidad rigurosas y disposiciones legales vigentes en la UE. Para garantizar la calidad, sometemos nuestros productos regularmente a controles de calidad adicionales, tanto a través de nuestro propio servicio de calidad como de un servicio de calidad externo. En el caso

improbable de que surgieran problemas a pesar de todas las precauciones, es posible recurrir a nuestra garantía (véase las condiciones de garantía).

#### **Condiciones generales referentes a la garantía sobre productos de venta al público (para la Unión Europea):**

- Todos los productos de venta al público tienen un período de garantía de 24 meses contra errores de producción o errores en materiales desde la adquisición original;
- Si la queja está fundada y si la reparación o sustitución de un artículo no es posible, o si los gastos son desproporcionados, Velleman® autoriza reemplazar el artículo por un artículo equivalente o reembolsar la totalidad o una parte del precio de compra. En este caso, usted recibirá un artículo de recambio o el reembolso completo del precio de compra si encuentra algún fallo hasta un año después de la compra y entrega, o un artículo de recambio al 50% del precio de compra o el reembolso del 50% del precio de compra si encuentra un fallo después de 1 año y hasta los 2 años después de la compra y entrega.

#### **Por consiguiente, están excluidos entre otras cosas:**

- todos los daños causados directa o indirectamente al aparato (p.ej. por oxidación, choques, caída,...) y a su contenido (p.ej. pérdida de datos) después de la entrega y causados por el aparato, y cualquier indemnización por posible pérdida de ganancias;
- partes o accesorios, que estén expuestos al desgaste causado por un uso normal, como por ejemplo baterías (tanto recargables como no recargables, incorporadas o reemplazables), bombillas, partes de goma, etc. (lista ilimitada);
- defectos causados por un incendio, daños causados por el agua, rayos, accidentes, catástrofes naturales, etc.;
- defectos causados a conciencia, descuido o por malos tratos, un mantenimiento inapropiado o un uso anormal del aparato contrario a las instrucciones del fabricante;
- daños causados por un uso comercial, profesional o colectivo del aparato (el período de garantía se reducirá a 6 meses con uso profesional);
- daños causados por un uso incorrecto o un uso ajeno al que está previsto el producto inicialmente como está descrito en el manual del usuario;
- daños causados por una protección insuficiente al transportar el aparato.
- daños causados por reparaciones o modificaciones efectuadas por una tercera persona sin la autorización explícita de Velleman®;
- se calcula gastos de transporte de y a Velleman® si el aparato ya no está cubierto por la garantía.
- Cualquier artículo que tenga que ser reparado tendrá que ser devuelto a su distribuidor Velleman®. Devuelva el aparato con la factura de compra original y transportélo en un embalaje sólido (preferentemente el embalaje original). Incluya también una buena descripción del fallo;
- Consejo: Lea el manual del usuario y controle los cables, las pilas, etc. antes de devolver el aparato. Si no se encuentra un defecto en el artículo los gastos podrían correr a cargo del cliente;
- Los gastos de transporte correrán a cargo del cliente para una reparación efectuada fuera del período de garantía.
- Cualquier gesto comercial no disminuye estos derechos.

**La lista previamente mencionada puede ser adaptada según el tipo de artículo (véase el manual del usuario del artículo en cuestión).**

### **DE**

#### **Velleman® Service- und Qualitätsgarantie**

Seit der Gründung in 1972 hat Velleman® sehr viel Erfahrung als Verteiler in der Elektronikwelt in über 85 Ländern aufgebaut. Alle Produkte entsprechen den strengen Qualitätsforderungen und gesetzlichen Anforderungen in der EU. Um die Qualität zu gewährleisten werden unsere Produkte regelmäßig einer zusätzlichen Qualitätskontrolle unterworfen, sowohl von unserer eigenen Qualitätsabteilung als auch von externen spezialisierten Organisationen. Sollten, trotz aller Vorsichtsmaßnahmen, Probleme auftreten, nehmen Sie bitte die Garantie in Anspruch (siehe Garantiebedingungen).

#### **Allgemeine Garantiebedingungen in Bezug auf Konsumgüter (für die Europäische Union):**

- Alle Produkte haben für Material- oder Herstellungsfehler eine Garantieperiode von 24 Monaten ab Verkaufsdatum.
- Wenn die Klage berechtigt ist und falls eine kostenlose Reparatur oder ein Austausch des Gerätes unmöglich ist, oder wenn die Kosten dafür unverhältnismäßig sind, kann Velleman® sich darüber entscheiden, dieses Produkt durch ein gleiches Produkt zu ersetzen oder die Kaufsumme ganz oder teilweise zurückzuzahlen. In diesem Fall erhalten Sie ein Ersatzprodukt oder eine Rückzahlung im Werte von 100% der Kaufsumme im Falle eines Defektes bis zu 1 Jahr nach Kauf oder Lieferung, oder Sie bekommen ein Ersatzprodukt im Werte von 50% der Kaufsumme oder eine Rückzahlung im Werte von 50 % im Falle eines Defektes im zweiten Jahr.
- **Von der Garantie ausgeschlossen sind:**
  - alle direkten oder indirekten Schäden, die nach Lieferung am Gerät und durch das Gerät verursacht werden (z.B. Oxidation, Stöße, Fall, Staub, Schmutz, Feuchtigkeit, ...), sowie auch der Inhalt (z.B. Datenverlust), Entschädigung für eventuellen Gewinnausfall.
  - Verbrauchsgüter, Teile oder Zubehörteile, die durch normalen Gebrauch dem Verschleiß ausgesetzt sind, wie z.B. Batterien (nicht nur aufladbare, sondern auch nicht aufladbare, eingebaute oder ersetzbare), Lampen, Gummiteile, Treibriemen, usw. (unbeschränkte Liste).
  - Schäden verursacht durch Brandschaden, Wasserschaden, Blitz, Unfälle, Naturkatastrophen, usw.
  - Schäden verursacht durch absichtliche, nachlässige oder unsachgemäße Anwendung, schlechte Wartung, zweckentfremdete Anwendung oder Nichtbeachtung von Benutzerhinweisen in der Bedienungsanleitung.

- Schäden infolge einer kommerziellen, professionellen oder kollektiven Anwendung des Gerätes (bei gewerblicher Anwendung wird die Garantieperiode auf 6 Monate zurückgeführt).

- Schäden verursacht durch eine unsachgemäße Verpackung und unsachgemäßen Transport des Gerätes.
- alle Schäden verursacht durch unautorisierte Änderungen, Reparaturen oder Modifikationen, die von einem Dritten ohne Erlaubnis von Velleman® vorgenommen werden.
- Im Fall einer Reparatur, wenden Sie sich an Ihren Velleman®-Verteiler. Legen Sie das Produkt ordnungsgemäß verpackt (vorzugsweise die Originalverpackung) und mit dem Original-Kaufbeleg vor. Fügen Sie eine deutliche Fehlerbeschreibung hinzu.
- Hinweis: Um Kosten und Zeit zu sparen, lesen Sie die Bedienungsanleitung nochmals und überprüfen Sie, ob es keinen auf der Hand liegenden Grund gibt, ehe Sie das Gerät zur Reparatur zurückschicken. Stellt sich bei der Überprüfung des Gerätes heraus, dass kein Geräteschaden vorliegt, könnte dem Kunden eine Untersuchungspauschale berechnet.
- Für Reparaturen nach Ablauf der Garantiefrist werden Transportkosten berechnet.
- Jede kommerzielle Garantie lässt diese Rechte unberührt.

**Die oben stehende Aufzählung kann eventuell angepasst werden gemäß der Art des Produktes (siehe Bedienungsanleitung des Gerätes).**

### **PT**

#### **Garantia de serviço e de qualidade Velleman®**

Desde a sua fundação em 1972 Velleman® tem adquirido uma ampla experiência no sector da eletrónica com uma distribuição em mais de 85 países.

Todos os nossos produtos respondem a exigências rigorosas e a disposições legais em vigor na UE. Para garantir a qualidade, submetemos regularmente os nossos produtos a controlos de qualidade suplementares, com o nosso próprio serviço qualidade como um serviço de qualidade externo. No caso improvável de um defeito mesmo com as nossas precauções, é possível invocar a nossa garantia. (ver as condições de garantia).

#### **Condições gerais com respeito a garantia sobre os produtos grande público (para a UE):**

- qualquer produto grande público é garantido 24 mês contra qualquer vício de produção ou materiais a partir da data de aquisição efectiva;
- no caso da reclamação ser justificada e que a reparação ou substituição de um artigo é impossível, ou quando os custos são desproporcionados, Velleman® autoriza-se a substituir o dito artigo por um artigo equivalente ou a devolver a totalidade ou parte do preço de compra. Em outro caso, será consentido um artigo de substituição ou devolução completa do preço de compra no caso de um defeito no prazo de 1 ano depois da data de compra e entrega, ou um artigo de substituição pagando o valor de 50% do preço de compra ou devolução de 50% do preço de compra para defeitos depois de 1 a 2 anos.

#### **• estão por consequência excluídos:**

- todos os danos directos ou indirectos depois da entrega do artigo (p.ex. danos ligados a oxidação, choques, quedas, poeiras, areias, impurezas...) e provocado pelo aparelho, como o seu conteúdo (p.ex. perda de dados) e uma indemnização eventual por perda de receitas;
- consumíveis, peças ou acessórios sujeitos a desgaste causado por um uso normal, como p.ex. pilhas (recarregáveis, não recarregáveis, incorporadas ou substituíveis), lâmpadas, peças em borracha correias... (lista ilimitada);
- todos os danos que resultem de um incêndio, raios, de um acidente, de uma catastrophe natural, etc.;
- danos provocados por negligência, voluntária ou não, uma utilização ou manutenção incorrecta, ou uma utilização do aparelho contrária as prescrições do fabricante;
- todos os danos por causa de uma utilização comercial, profissional ou colectiva do aparelho ( o período de garantia será reduzido a 6 meses para uma utilização profissional);
- todos os danos no aparelho resultando de uma utilização incorrecta ou diferente daquela inicialmente prevista e descrita no manual de utilização;
- todos os danos depois de uma devolução não embalada ou mal protegida ao nível do acondicionamento.
- todas as reparações ou modificações efectuadas por terceiros sem a autorização de SA Velleman®;
- despesas de transporte de e para Velleman® se o aparelho não estiver coberto pela garantia.
- qualquer reparação será fornecida pelo local de compra. O aparelho será obrigatoriamente acompanhado do talão ou factura de origem e bem acondicionado (de preferência dentro da embalagem de origem com indicação do defeito ou avaria);
- dica: aconselha-mos a consulta do manual e controlar cabos, pilhas, etc. antes de devolver o aparelho. Um aparelho devolvido que estiver em bom estado será cobrado despesas a cargo do consumidor;
- uma reparação efectuada fora da garantia, será cobrado despesas de transporte;
- qualquer garantia comercial não prevalece as condições aqui mencionadas.

**A lista pode ser sujeita a um complemento conforme o tipo de artigo e estar mencionada no manual de utilização.**

### **PL**

#### **Velleman® usługi i gwarancja jakości**

Od czasu założenia w 1972, Velleman® zdobył bogate doświadczenie w dziedzinie światowej elektroniki. Obecnie firma dystrybuuje swoje produkty w ponad 85 krajach.

Wszystkie nasze produkty spełniają surowe wymagania jakościowe oraz wypełniają normy i dyrektywy obowiązujące w krajach UE. W celu zapewnienia najwyższej jakości naszych produktów, przechodzą one regularne oraz dodatkowo wrywkowe badania kontroli jakości, zarówno naszego wewnętrznego działu jakości jak również

wyspecjalizowanych firm zewnętrznych. Pomimo dołożenia wszelkich starań czasem mogą pojawić się problemy techniczne, prosimy odwołać się do gwarancji (patrz warunki gwarancji).

**Ogólne Warunki dotyczące gwarancji:**

- Wszystkie produkty konsumenckie podlegają 24-miesięcznej gwarancji na wady produkcyjne i materiałowe od daty zakupu.
- W przypadku, gdy usterka jest niemożliwa do usunięcia lub koszt usunięcia jest nadmiernie wysoki Velleman ® może zdecydować o wymianie artykułu na nowy, wolny od wad lub zwrócić zapłaconą kwotę. Zwrot gotówki może jednak nastąpić z uwzględnieniem poniższych warunków:
  - zwrot 100% ceny zakupu w przypadku, gdy wada wystąpiła w ciągu pierwszego roku od daty zakupu i dostawy
  - wymiana wadliwego artykułu na nowy, wolny od wad z odpłatnością 50% ceny detalicznej lub zwrot 50% kwoty ceny nabycia w przypadku gdy wada wystąpiła w drugim roku od daty zakupu i dostawy.
- **Produkt nie podlega naprawie gwarancyjnej:**
  - gdy wszystkie bezpośrednie lub pośrednie szkody spowodowane są działaniem czynników środowiskowych lub losowych (np. przez utlenianie, wstrząsy, upadki, kurz, brud, ...), wilgotności;
  - gwarant nie ponosi odpowiedzialności za szkody wynikających z utraty danych;
  - produkty konsumenckie, części zamienne lub akcesoria podatne na process starzenia, wynikającego z normalnego użytkowania, np: baterie (ładowalne, nieładowalne, wbudowane lub wymienne), żarówki, paski napędowe, gumowe elementy napędowe... (nieograniczona lista);
  - usterka wynika z działania pożaru, zalania wszelkimi cieczami, uderzenia pioruna, upadku lub klęski żywiołowej, itp.;
  - usterka wynika z zaniedbań eksploatacyjnych tj. umyślnie bądź nieumyślnie zaniechanie czyszczenia, konserwacji, wymiany materiałów eksploatacyjnych, niedbalstwa lub z niewłaściwego obchodzenia się lub niezgodnego użytkowania z instrukcją producenta;
  - szkody wynikające z nadmiernego użytkowania gdy nie jest do tego celu przeznaczony tj. działalność komercyjna, zawodowa lub wspólne użytkowanie przez wiele osób - okres obowiązywania gwarancji zostanie obniżony do 6 (sześć) miesięcy;
  - Szkody wynikające ze źle zabezpieczonej wysyłki produktu;
  - Wszelkie szkody spowodowane przez nieautoryzowaną naprawę, modyfikację, przeróbkę produktu przez osoby trzecie jak również bez pisemnej zgody firmy Velleman ®.
- Uszkodzony produkt musi zostać dostarczony do sprzedawcy ® Velleman, solidnie zapakowany (najlepiej w oryginalnym opakowaniu), wraz z wyposażeniem z jakim produkt został sprzedany. W przypadku wysyłki towaru w opakowaniu innym niż oryginalnym ryzyko usterki produktu oraz tego skutki przechodzą na właściciela produktu. Wraz z niesprawnym produktem należy dołączyć jasny i szczegółowy opis jego usterki, wady;
- Wskazówka: Aby zaoszczędzić na kosztach i czasie, proszę szczegółowo zapoznać się z instrukcją obsługi; czy przyczyną wady są okoliczności techniczne czy też wynikają wyłącznie z nieznanomości obsługi produktu. W przypadku wysyłki sprawnego produktu do serwisu nabywca może zostać obciążony kosztami obsługi oraz transportu.
- W przypadku napraw pogwarancyjnych lub odpłatnych klient ponosi dodatkowo koszt wysyłki produktu do i z serwisu. wymienione wyżej warunki są bez uszczerbku dla wszystkich komercyjnych gwarancji.

**Powyższe postanowienia mogą podlegać modyfikacji w zależności od wyrobu (patrz art obsługi).**

---