

HAA2890

DUAL RELAY DIGITAL ACCESS CONTROL READER KEYPAD - WEATHERPROOF



USER MANUAL

4



TABLE OF CONTENTS

INTRODUCTION	4
FEATURES	4
SPECIFICATIONS	5
INSTALLATION	6
Precautions	6
Package Contents	6
CONNECTION HARNESS	7
The On-Board LED Indicators	8
The Pacifier Tones & The LED Signals	8
FEATURE PROGRAMMING & OPERATION INSTRUCTIONS	9
Set System in Programming Mode with The Master Code	9
Direct Access to Programming Mode with The "DAP" Code – 8 0 8 0	9
Refresh The System with The "Refreshing Code" --- 9 9 9 9	10
The Default Values of The Keypad	10
KEYPAD PROGRAMMING MAKE SIMPLE – For General Users	11
FEATURE PROGRAMMING -- KEY IN AND STORE THE DESIRED VALUES	13
Programming Criteria for Codes	13
Record A Master Code	14
Record A Super User PIN	14
Operation And Functions of The Super User PIN	15
Record The Common User PINs for Output 1	15
Record-Delete PINs or Cards for Output 1	16
Examples – Programming And Operation	17
Visitor Codes (For Output 1 Only)	19
Configuration of The Output Modes for Output 1	20
Personal Safety And System Lock-Out	20
User PIN Entry Mode	21
Pacifier Tones On-Off Selection	21
Output Operation Announcer	22
Status LED Flashing On-Off during Standby	22
Intelligent Egress Button – An Unique Feature of A Contemporary Keypad	23
Where And Why "Going Out" Needs Attention	23
Egress Delay and Warning	24
Configurations of The Egress Warning And Alarm	24
Close The Programming Mode	25
The Operation Modes	26
Wiegand Output at Keypad Operation Mode	26
THE APO DATA I/O PORT -- FOR SETTING UP A SPLIT-DECODED KEYPAD	27
The Optional DA-2800 Controller --- Introduction	27
PROGRAMMING SUMMARY CHART	28
APPLICATION EXAMPLE	30
Basic Wirings of A Stand Alone Door Lock	30
APPLICATION HINTS FOR THE AUXILIARY TERMINALS	31

To all residents of the European Union
Important environmental information about this product



This symbol on the device or the package indicates that disposal of the device after its lifecycle could harm the environment.
Do not dispose of the unit (or batteries) as unsorted municipal waste; it should be taken to a specialised company for recycling.

This device should be returned to your distributor or to a local recycling service.

Respect the local environmental rules.

If in doubt, contact your local waste disposal authorities.

INTRODUCTION

The HAA2890 is a weatherproof, self-contained, mullion mount compact keypad. It combines the functions of digital keypad and proximity EM card reader in one unit.

The HAA2890 has been designed to work independently as a stand alone keypad or works together with an optional "APO controller" to form a high security split-decoded keypad system.

The keypad comes with plenty of functions for owner's selection via programming. Owners can take them freely to tailor the desired features for their system.

HAA2890 is an ideal keypad mainly for Door Strike or Alarm Arm-disarm control. It is also a programmable industrial timer (with the timing of 1 second to over 24 hours) for Automatic Operator systems.

The unit is designed for surface mounting on wall or door frame. The two relay outputs are coming with N.C. and N.O. Contacts for Door strike and N.O. Contact for Door Bell.

FEATURES

- A Member of The Tri-Tech Series Keypads Compatible with The APO Access Controller, DA-2800 or DA-2801
- Durable Epoxy Coated Back-lit Key Board with Door Bell Button
- Mullion Surface Mount Plastic Housing
- Operated with PINs & EM Cards
- Self-contained, Stand-Alone Operation
- Built-in Data I/O Port Expandable for Split-decoded Operation
- Relay Output Contacts for Door Strike and Door Bell

THE OPTIONAL CONTROLLERS FOR SPLIT-DECODED OPERATION

DA-2800 -- Full Feature Decoder + RF Remote Control

DA-2801 -- Full Feature Decoder

SPECIFICATIONS

- **Operating Voltage:**
12V DC Nominal; 11-15V DC
- **Operating Current:**
60mA (quiescent) to 95mA (two relays active)
- **Operation Temperature:**
-20°C to +70°C
- **Environmental Humidity:**
5-95% relative humidity non-condensing
- **Working Environment & Ingress Protection:**
Indoor or Outdoor, IP-55 Weatherproof
- **Number of Users:**
1,000 (PINs and/or Cards)
- **Proximity Card:**
Standard EM Card or Keyfob, 125Khz
- **Number of Visitor Codes:**
50, programmable for one time or with the time limit
- **Timings for Code Entry and Card Reading:**
10 seconds waiting for next digit entry
30 seconds waiting for code entry after card reading
- **The Timer:**
1-99,999 Seconds (Over 24 Hours possible) Programmable Timer for O/P 1
- **Egress Button:**
Programmable for Instant, Delay with Warning and/or Alarm
Momentary or Holding Contact for the Exit Delay
- **Output Contact Ratings:**
Output Relay 1 – N.C. & N.O. dry contacts, 2A/24VDC Max.
Door Bell Relay – N.O. dry contact, 1A/24VDC Max.
Tamper Switch – N.C. dry contact, 50mA/24VDC Max. , Magnet Operated Reed Switch
- **Dimensions:**
168.5(H) X 46.5(W) X 24(D)mm
- **Weight:**
160g net
- **Housing:**
ABS Plastic Box

Specifications are subject to change for modification without notice

INSTALLATION

HAA2890



PRECAUTIONS

1) Prevent Interference:

The EM Card reader is working at the frequency of 125Khz. Installation precautions are necessary.

- i) Make sure the location for installation has no strong low frequency electro-magnetic wave signals. Especially in the range of 100-200Khz
- ii) If there is more than one keypads with the same operation frequency installed closely in the same location, make sure that they are at least 60cm (2ft) apart from each other to prevention interference.

2) Prevent Accidental Short Circuit:

In the previous experience, most of the damages caused in the installation are accidental touching of the components on circuit board with the wires carrying power. Please be patient to study the manual to become familiar with the specifications of the system before starting the installations.

- i) Do not apply power to the system while it is in installation.
- ii) Check carefully all the wirings are correct before applying power to the system for testing.

PACKAGE CONTENTS

- One HAA2890 Keypad
- Two EM cards or keyfobs
- One pack of Mounting Screws
- One Programming & Installation Manual
- One Connection Harness

CONNECTION HARNESS

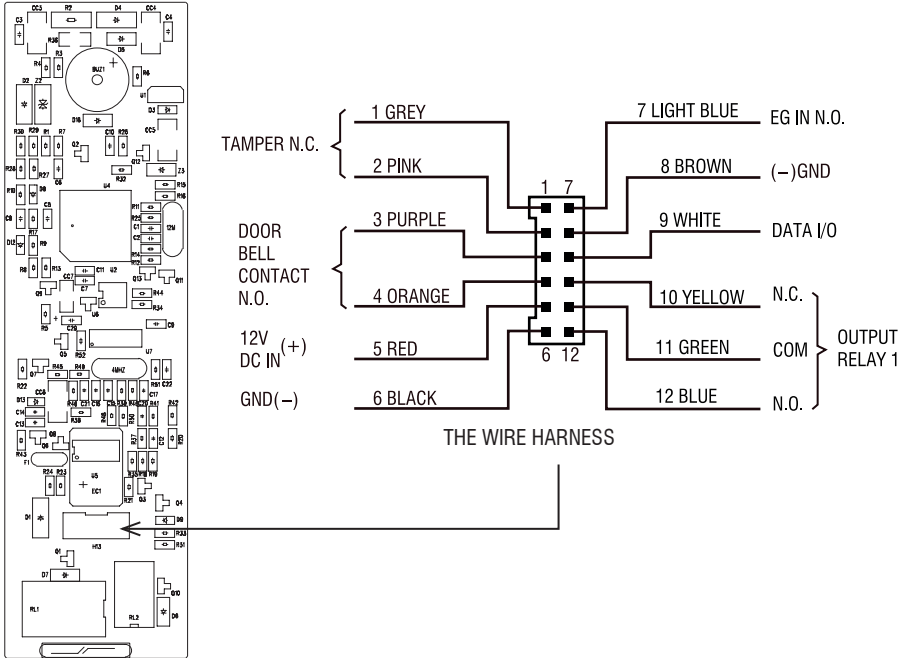

- **1 - 2 : TAMPER N.C. (Tamper Switch Normally Closed Contact)**

A normally closed dry contact while the front cover is secured on the main box. It is open while the cover is separated from the box. Connect this N.C. terminal to the 24 hour protection zone of an alarm system if necessary.

- **3 - 4 : DOOR BELL (Output Relay Contact for Door Bell)**

It is a Normally Open (N.O.) relay dry contact with maximum rating of 24VDC/1Amp. It is prepared as a triggering contact of a low voltage door chime. The contact point keeps close as long as the bell button on the keypad is pressed.

- **5 - 6 : 12V DC (Power Input Terminal)**

Connect to 12V DC power supply. The (-) supply and the (-) GND are the common grounding points of the system.

- **7 : EG IN (Egress Input)**

A Normally Open (N.O.) input terminal referring to (-) ground. With the help of connecting a normally opened button to activate Output 1 for door opening in the same manner of using the Group 1 User PINs or Cards. Egress button is usually put inside the house near the door. More than one egress buttons can be connected in parallel to this terminal. Leave this terminal open if not used. See Programming Location 90 for more information about the Egress Button with other features.

- **8 : GND (-) (Common Ground)**

A common grounding point of the keypad

- **9 : DATA I/O (Data Input/Output Port for Split-Decoded Operation)**

A data bus for signal communication with the optional Access Controller in Split-decoded operation. See "THE APO I/O PORT" Section for the details.

● **10 - 11 - 12 : OUTPUT 1 (Output Relay 1)**

2 Amp relay dry contact controlled by the Group 1 user PINs or Cards for Output 1, recommended for door strike. Terminal 10 is Normally Closed (N.C.), terminal 12 is Normally Open (N.O.) and terminal 11 is the common point of the two contacts. Use N.C. output for Fail-safe locking device; and N.O. output for Fail-secure locking device. The relay is programmable for Start/Stop (toggle) mode or Momentary timing mode. See programming Location 51 for the details.

THE ON-BOARD LED INDICATORS

- **MAINS (AMBER)** ----- It flashes on Standby. It shows the system status in synchronization with the beep tones. The standby flashing can be set to OFF in programming. See Location 73 for the details.
- **DOOR (GREEN)** ----- It lights up for Output 1 activation.
- **INHIBIT (RED)** ----- It lights up while the output is inhibited.

THE PACIFIER TONES & THE LED SIGNALS

The buzzer and the amber LED indicator give following tones and signals respectively for system status:

STATUS	TONES *	LED SIGNALS
1) On Programming Mode	-----	ON
2) Successful Key Entry	1 Beep	1 Flash
3) Successful Code / Card Entry	2 Beeps	2 Flashes
4) Unsuccessful Code / Card Entry	5 Beeps	5 Flashes
5) Power Up Delay	Continuous Beeps	Continuous Flashes
6) Output Relay Activation **	1 Second Long Beep	
7) On Standby ***	-----	1 Flash in 1 Second Interval
8) System Refreshing	-----	Fast Flashes for 2.5 Minutes
9) Card or PIN Already Stored in System	1 Long Beep	-----

NOTE:

- * All Pacifier Tones can be ON or OFF through the programming option at Location 71
- ** The Output Relay Activation beep can be selected through the programming option at Location 72
- *** The Standby flashing can be ON or OFF through the programming option at Location 73

FEATURE PROGRAMMING & OPERATION INSTRUCTIONS

SET SYSTEM INTO PROGRAMMING MODE WITH THE MASTER CODE

IMPORTANT NOTE:

- 1) **DO NOT TURN OFF POWER** while the keypad is in Programming Mode. Otherwise, it may cause data lost/error to the programmed features in the memory.
- 2) The keypad beeps after power up. Wait 1 minute until the end of the power up delay, then key in the Master Code for setting the system into programming mode.
- 3) For the owner's convenience in programming at the first time, the factory has put a Master Code **0 0 0 0** into the keypad (**It is NOT a default code**). To compromise security, in all cases, the owner should program a new Personal Master Code to invalidate the factory set Master Code after the keypad is owned.



MASTER CODE

- The Master Code can be a factory set master code or the private master code that was set by the owner.
- Validate the master code with * * . 2-beep confirms a valid master code. The Mains LED (Amber) is constantly ON after the system is set in the programming mode.

DIRECT ACCESS TO PROGRAMMING MODE WITH THE “DAP” CODE – 8 0 8 0

Set System Into Programming Mode With DAP Code In Case Of The Master Code Is Forgotten ! !

The owner requires to apply the following procedures precisely to set the system into programming mode with the DAP code **8 0 8 0**.

- 1) Switch OFF all the power for 1 minute to ensure that the system is fully discharged.
- 2) Switch ON power again. The system is in Power-up Mode for 1 minute and the buzzer gives beeps during the whole period. This is the only time limit for setting the system to Direct Access to Programming (DAP).
- 3) Press the Egress Button (EG IN) once first to enable the DAP function.
- 4) Key in the DAP Code **8 0 8 0** and validate it with * * , **the existing Master Code in the memory is erased** and the power up beep stops. The keypad turns itself into programming mode like using the Master Code and it is ready to accept the new programming data.
- 5) If the Egress Button is not pressed and the DAP code is not keyed in within the power up period, the system will set itself to normal operation mode. To set it back to power-up mode, repeat procedures 1-4.

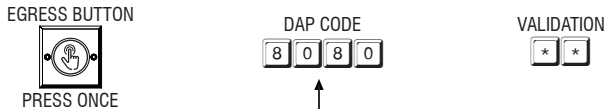

DAP CODE

- The DAP code is fixed on **8 0 8 0** and it is valid only in the Power-up Period after the Egress Button is pressed.
- Validate the DAP code with the * * .
- 2-beep confirms the system is in the Programming Mode; and the Mains LED is constantly ON.
- See “RECORD A MASTER CODE” at “Location 01” for the details of programming a new master code.

NOTE:

If the keypad is linking up with the DA-2800 or DA-2801 controller in the Split-decoded operation, it is necessary to put the controller's “Link-up Jumper” to “ON” position to get the new Master Code for it. As the Master Code is also the link-up code of the two units. **Do Not Forget** to put the Link-up jumper back to OFF position after the programming.

REFRESH THE SYSTEM WITH THE “REFRESHING CODE” --- 9 9 9 9

The system can be refreshed to clear all the old data stored and back to its ex-factory default values.

IMPORTANT NOTE:

Make sure that you really want to clear **ALL the OLD** data before entering of the Refreshing Code. The keypad will be back with its default values like a new unit. Re-program of the desired values are necessary.



REFRESHING CODE

- The Code **9 9 9 9** is for refreshing of the system. Once it is keyed in and validated with #, all the values programmed previously will be cleared **EXCEPT the Master Code**.
- The refreshing takes around 2.5 minutes. During the keypad is being refreshed the Status LED (Amber) flashes fast until the end.

THE DEFAULT VALUES OF THE KEYPAD

PROGRAMMING

LOCATION	PARAMETERS	DEFAULT FUNCTIONS & VALUES
0 1	Master Code	0 0 0 0 Factory Set, Not a default value *
0 2	Super User PINs	Nil ----- User Program Required
0 3	Common User PIN 1	Nil ----- User Program Required
1 0	User PINs & Cards for O/P 1	Nil ----- User Program Required
4 0	Visitor Codes	Nil ----- User Program Required
5 1	O/P Mode of The O/P 1	Time = 5 Sec, Momentary
6 0	Personal Safety & Lock-out	Code = 1, 10 False Code/Card Lock-out 60 Sec
7 0	User Code Entry Mode	Code = 2, Manual Entry Mode
7 1	Pacifier Tones ON-OFF Selection	Code = 1, Pacifier Tone ON
7 2	O/P Operation Announcer	Code = 1 Sec, Notification Beep ON
7 3	Status LED Standby Flashing ON-OFF	Code = 1, Flashing Enabled
9 0	Egress Delay & Warning	Code 1 = 0, Instant, No Delay
		Code 2 = 1, Momentary Contact without Warning
9 4	Operation Modes	Code = 0, Stand Alone Keypad

NOTE:

The DAP Code **8 0 8 0** and the Refreshing Code **9 9 9 9** are fixed in the operating system program. It can not be changed in any ways or be influenced by the system in default setting.

KEYPAD PROGRAMMING MAKE SIMPLE – For General Users

The HAA2890 has many functions for user's selection. For those general users taking the keypad for door strike only, most of the features can be kept in their Default values. Only the User PINs / Cards and a private Master Code are necessary to program for the system.

The keypad accepts **1) Card only**, **2) PIN only**, **3) Card + PIN** or **4) Card + Common User Code** to operate its outputs.

PROGRAMMING

NOTE: Wait 1 minute until the end of the power up delay.

1) Set System into Programming Mode with The Factory Set Master Code **0000**

---- 2 beeps, system is in Programming Mode

Note: If the Master Code is forgotten, use the DAP Code to set the system into programming mode. See DAP CODE 8080 on the previous page for the details.

2) Change The Factory Set Master Code to Owner's Private Master Code for Security Reason

---- 2 beeps, 3 2 8 9 is a Master Code for example here only

3289 is the new Master Code and the 0000 is erased

3) Record an "EM Card" to Operate The Output 1 for Door Open

(a) (b) (c) (d) (e)

- (a) 10 = Programming Location for Output 1
- (b) 1 = Programming option for EM Card only
- (c) 001 = One of the 1,000 User IDs for the User PIN/Card from 000-999
- (d) Read Card = Put the Card close to the card reader
- (e) # = Confirm the card is read, 2 beeps

4) Set an "User PIN" to Operate The Output 1 for Door Open

(a) (b) (c) (d) (e)

- (a) 10 = Programming Location for Output 1
- (b) 2 = Programming option for User PIN only
- (c) 002 = One of the 1,000 User IDs for the User PIN/Card from 000-999
- (d) 8321 = The User PIN that is programmed for door open. 8321 is an User PIN for example here only
- (e) # = Confirm the User PIN, 2 beeps

5) Record an "EM Card + User PIN" to Operate The Output 1 for Door Open

(a) (b) (c) (d) (e) (f)

- (a) 10 = Programming Location for Output 1
- (b) 3 = Programming option for EM Card + User PIN. (The User PIN can be repeated use or proprietary)
- (c) 003 = One of the 1,000 User IDs for the User PIN/Card from 000-999
- (d) Read Card = Put the Card close to the card reader
- (e) 6123 = The User PIN to be used with the EM Card. 6123 is an User PIN for example here only.
- (f) # = Confirm the Card+PIN is stored, 2 beeps

6) Record an “EM Card + Common User Code” to Operate The Output 1 for Door Open

- (a) 10 = Programming Location for Output 1
- (b) 4 = Programming option for EM Card + Common User Code
- (c) 004 = One of the 1,000 User IDs for the User PIN/Card from 000-999
- (d) Read Card = Put the Card close to the card reader
- (e) # = Confirm the card is read, 2 beeps, the Common User Code goes to this User ID automatically
- (f) A Common User Code (for example: 8 6 2 5) **MUST** be set at the Programming **Location 03** first for this operation mode. The code can be used for all the EM Cards in this operation mode.

REMARK:

If more User PINs and Cards are required for Output 1, repeat the procedures (3) , (4) , (5) or (6) above with other User IDs, such as 005, 006, 007 --- 999 etc. Total 1,000 users are allowed. See Programming Location 10 for the details.

7) Close The Programming Mode

---- 2 beeps

The programming mode is closed. The keypad is back to normal operation mode

OPERATION

8) Open The Door with The EM CARD

---- 2 beeps, the door is open

9) Open The Door with The User PIN

---- 2 beeps, the door is open

10) Open The Door with The EM CARD + User PIN

---- 2 beeps, the door is open

11) Open The Door with The EM CARD + Common User Code

---- 2 beeps, the door is open

REMARK:

In the next Section, “KEY IN AND STORE THE DESIRED VALUES” describes all the features and functions of the system in detail. Users can follow them to tailor the desired values for their access control systems. Suggest the general users also spend some time on them to get acquaint with this powerful system for future expansion.

FEATURE PROGRAMMING -- KEY IN AND STORE THE DESIRED VALUES

The feature values can be set and stored into the system one by one with the desired **Programming Locations**. Programming can be made continuously and it is not necessary to be in sequence order. Just go to the desired programming location and key in the value for the desired feature.

IMPORTANT NOTE --- Programming Criteria for Codes:

a) The Prime Codes:

All the Private User PINs, Master Code, Duress Codes, Super User PIN, Common User Code and the Visitor User Codes belong to Prime Codes in the system. They have the priority to be read and they **MUST be unique** and can not be repeated in the programming. A Prime code also can **NOT** be duplicated for a Secondary code to work with the EM Card or vice versa.

b) The Prime Cards:

All the EM Cards used in this system are Prime Cards. The cards **MUST be unique** and can not be repeated use. The Card always has the priority to be read when working with an User PIN in "EM Card + Secondary PIN" or EM Card + Common User PIN".

c) Warning for A Repeated Use of Prime Code or Card:

One long beep is given if a Code/PIN is keyed in or a Card is read. It means that a Prime Code or a Prime Card is repeated. The Code/PIN or Card was already in one of the PIN or Card Locations or IDs. The programming is invalid. Change a new Code/PIN or Card and program it again.

d) Secondary User PINs:

The Secondary User PINs are prepared to enhance security. It is put after a Card in "**EM Card + Secondary User PIN**" programming. They can be a repeated code within the Secondary PINs but it is **NOT** allowed a duplicate of the Prime Codes. The system will reject a duplicated Prime Code for Secondary User PIN or vice versa.

e) Getting Advantages from The Secondary User PINs:

The repeated Secondary PINs can be used as a Group Common User Code or called Department User Code for a group of EM Cards, which simplifies the programming of using large number of different User PINs. EM Card with Department Code prevents a lost card used by people of other department. Also, it will be easier to trace out the department of the lost card belongs to. Of course, the owner can use a proprietary Secondary User PIN for each EM Card in the "**EM Card + Secondary User PIN**" programming to further increase the security if it is the main concern.

f) Security Level Comparison of The Secondary User PIN/Code following Card Reading:

- i) EM Card + Common User Code --- All EM Cards use the same User Code. Security level is better than just Card only. A lost Card picked up by any people can be used if he knows the Common User Code.
- ii) EM Card + Department User Code --- The EM Cards are divided into groups with a Department User Code. A lost Card can be used only by the people in the same group who know the Department Code.
- iii) EM Card + Secondary User PIN --- Each EM Card has its own proprietary User PIN. A lost Card can not be used by other people.

g) Make A List Recording of The User Names VS User Codes:

Suggest the owner to make a list recording of the User Names corresponding to the Codes/PINs/Cards that are going to store in the Locations and the IDs before the programming. It will be a useful tool for the owner to easily program them smoothly and also to trace them from this multi-users system in the future.

Example: (Please see the following page)

Example:

User	Name	Location	Function Code	User ID	PIN/Code	Card #	Remark
1							
2							
3							
4							
5							
6							
7							
8							
9							
10							
11							
12							
13							
14							
15							
16							
--							
1,000							

RECORD A MASTER CODE

(Location 01)

LOCATION

0 1

MASTER CODE

4 to 8 Digits

VALIDATION

#

MASTER CODE

- Master Code is the authorization code for setting the system to programming mode. It is **NOT** an User Code operating of the output relays.
- The Master Code can be 4 to 8 digits. Press # key to confirm code entry
- When a new master code is keyed in and confirmed, the old master code is replaced automatically.
- The master code is also the **Link-up Code** between the keypad and the optional controller of the system in Split-decoded operation.
- **Example:** Set a Master Code with the number of "2 2 3 3" ---- 0 1 2 2 3 3 #

RECORD A SUPER USER PIN

(Location 02)

The Super User PIN has TWO functions. It is prepared for the owner to use it to operate the keypad under inhibit condition and make operation of inhibit enable / disable to the system output.

LOCATION

0 2

SUPER USER PIN

4 to 8 Digits

VALIDATION

#

SUPER USER PIN

- The Super User PIN can be 4 to 8 digits.
- Two beeps will be heard after pressing the # key to confirm code entry.
- When a new Super User PIN is keyed in and confirmed, the old one is replaced.
- **Example:** Set a Super User PIN with the number of "2 5 8 0" ---- 0 2 2 5 8 0 #
- To deleted a Super User PIN from memory: Key in just the Location number and #. ---- 0 2 #

OPERATION AND FUNCTIONS OF THE SUPER USER PIN

1) Operate Output 1 (Output Relay 1)

The operation of the Super User PIN is just like a normal User PIN. Simply key-in the PIN with a specific output number for the Output. The Super User PIN can also be used to reset an operating output timer instantly.

SUPER USER PIN **#** **1** ----- Output 1 Activates or Resets

2) Inhibit The User PINs For Output 1

The Super User PIN can also be used to inhibit the normal User PINs/Cards for the Output 1 (usually they are for door strike). It enhances the security level of the access control system, such as to stop a keypad after office hour or while the house is nobody inside. Once the Output 1 is inhibited, the User PINs/Cards for it become invalid and those people even know the User PINs are refused during the system is inhibited. The inhibit function is toggled in Start / Stop mode with the following code entry.

SUPER USER PIN **#** **9** ----- The Whole Group of User PINs & Cards for Output 1 are Disabled or Enabled in Toggle

NOTE:

- The inhibit function setting with the Super User PIN applies to the whole group of User PINs and Cards for Output 1.
- For safety reason, the inhibit function initiated with the Super User PIN does not govern the Egress Button. The door still can be opened with it from inside.
- The function of the Super User PIN is not affected in the Inhibited Mode or Lock-out Mode. It is always a normal user code for Output 1.

RECORD THE COMMON USER PINS FOR OUTPUT 1

(Location 03)

The Common User PIN is prepared for operating of the Output 1 as an enhance code. The Common User PINs **MUST** work in the form of "Card + Common PIN" to operate the outputs to increase the security of the access control system. See Location 10 for more information.

NOTE : Common User PIN alone can **NOT** be used to operate Output 1 directly.

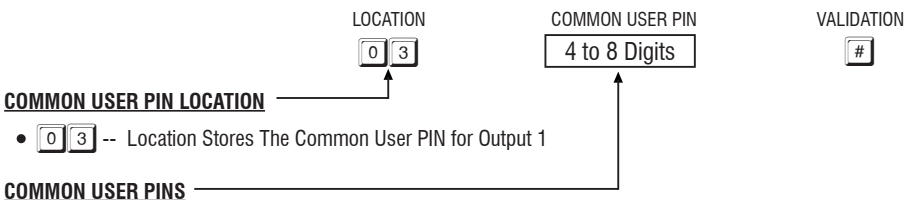

COMMON USER PIN LOCATION

- **03** -- Location Stores The Common User PIN for Output 1

COMMON USER PINS

- The Common User PIN can be 4 to 8 digits. Press # key to confirm the code entry.
- When a new Common User PIN is keyed in and confirmed, the old one is replaced.

- **Example**: Set a Common User PIN with the number of "1 3 5 7" for Output 1 ---- **03** **1357** **#**
- To deleted a Common User PIN from memory: Key in just the Location number and #. ---- **03** **#**

RECORD-DELETE PINS OR CARDS FOR OUTPUT 1

(Location 10)

Total of 1,000 **User PINs and/or Cards** are available for controlling of the output relay 1.

The Private User PINs and Cards **MUST** be unique. Repeated PINs will be rejected. Secondary User PINs in the “EM Card + Secondary User PIN” can be repeated. See the **Important Note --- Programming Criteria for Codes** in page 13 for more information.

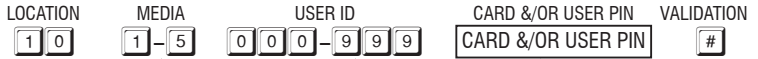

USER GROUP LOCATION

1 0 – Group 1 --For User PINs/Cards Controlling Output 1
1,000 Users are allowed in group 1 for O/P 1

SELECTION OF OPERATION MEDIA

- Number 1, 2, 3 or 4 represents the Media to be used to operate the keypad.
- Number 5 is the authorization code for deleting of an PIN and/or Card from its User ID.

1 = EM Card only;

2 = Private User PIN only;

3 = EM Card + Secondary User PIN

4 = EM Card + Common User PIN

5 = Delete an User PIN &/or Card from the selected User ID number

0 9 9 9 = Clear all the PINs & Cards from the selected Location. It takes few seconds to a minute to complete depending on the Location selected and the data stored. Please see the programming example below for the details.

USER ID NUMBER

- A 3-digit ID is an identified number for each User PIN and/or Card.
- Repeated ID number will be rejected by the system

ID Number 0 0 0 – 9 9 9 for 1,000 User PINs/Cards to operate Output 1

CARD &/OR USER PINS

- The User PINs can be 4-8 digits. Key in the User PIN on each ID Number box, then confirm it with # key
- Just simply put the EM card close to the reader window to read it on each ID Number box, then, confirm it with # key if it is a **Card ONLY**, or **Card + Common User PIN** entry. The Common User PIN is **NOT** required to key-in here. It will go into its location automatically after the Card is read.
- Read the Card first, then key in the Secondary User PIN on each ID Number box, then confirm it with # key if it is **Card + Secondary User PIN**. The Secondary User PINs can be duplicated or a proprietary User PIN but can not be a duplicate of a Prime Code. Owner can use the same secondary User PIN for a group of Cards as a group Common User Code (or called Department Code) for a specific relay output.
- Cards (Operation Media # 1, 3, & 4) and Private User PINs (Operation Media 2) **MUST** be unique. A repeated EM card or Private User PIN will be rejected and one long beep will be generated by the system to notify the owner.

EXAMPLES – PROGRAMMING AND OPERATION

1) Example 1 -- EM Card Only :

i) Programming :

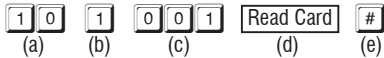

- (a) The card is programmed for operating of the Output 1
- (b) The operation is EM Card only
- (c) Take ID number 001 in Group 1 to store the card, which is one of the IDs in 000-999
- (d) Put the card close to the reader to read it, one beep confirms the reading
- (e) Press # to store the “Card” into memory, two-beep confirms a valid entry

ii) Operation : (while the system is back to operation mode)

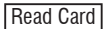

(a)

- (a) Put the EM card close to the reader. Two-beep confirms the card is read and the Output 1 activates

2) Example 2 -- Private User PIN Only :

i) Programming :

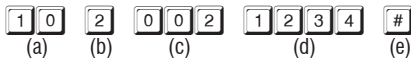

- (a) The Private User PIN is programmed for operating of the Output 1
- (b) The operation is Private User PIN only
- (c) Take ID number 002 in Group 1 to store the Private User PIN, which is one of the IDs in 000-999
- (d) Put Private User PIN “1 2 3 4” into the storage location
- (e) Press # to confirm and store the “Private User PIN” into memory, two-beep confirms a valid entry

ii) Operation : (while the system is back to operation mode)

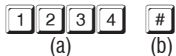

(a)

(b)

- (a) Key in the Private User PIN “1 2 3 4”
- (b) Confirm it with the # key. Output 1 activates

3) Example 3 -- EM Card + Secondary User PIN :

i) Programming :

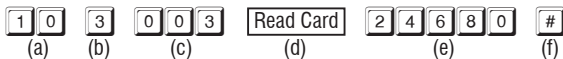

- (a) The card is programmed for operating of the Output 1
- (b) The operation is EM Card + Secondary User PIN
- (c) Take the ID number 003 in Group 1 to store the Card & PIN, which is one of the IDs in 000-999
- (d) Put the card close to the reader. One beep confirms the reading
- (e) Put Secondary User PIN “2 4 6 8 0” into the storage location
- (f) Press # to store the “Card + Secondary User PIN” into memory, two-beep confirms a valid entry

ii) Operation : (while the system is back to operation mode)



(a)

(b)

(c)

- (a) Put the EM card close to the reader. Two-beep confirms the reading and 30 seconds waiting time is given for the entry of the User PIN, the Amber LED keeps flashing
- (b) Key in the Secondary User PIN “2 4 6 8 0”
- (c) Confirm it with the # key. Output 1 activates

4) Example 4 -- EM Card + Common User PIN :

i) Programming :

(a) (b) (c) (d) (e)

- The card is programmed for operating of the Output 1
- The operation is "EM Card + Common User PIN"
- Take ID number 004 in Group 1 to store the card, which is one of the IDs in 000-999
- Put the card close to the reader. One beep confirms the reading. (No need to key in a Common User PIN but there **MUST** be a Common User PIN already recorded in Location 03;
- Press # to store the "Card" into memory. Two-beep confirms a valid entry

ii) Operation : (while the system is back to operation mode)

(a) (b) (c)

- Put the EM card close to the reader. One-beep confirms the reading and 30 seconds waiting time is given for the entry of the Common User PIN, the Amber LED keeps flashing
- Key in the Common User PIN "1 3 5 7" (the number programmed in "Location 0 3" for Output 1 in the previous Example)
- Confirm it with the # key. Output 1 activates

5) Example 5 -- Delete an User PIN & / or EM Card :

i) Delete An User PIN or A Lost EM Card

(a) (b) (c) (d)

- Key in the User Group that the User ID belongs to. "10" for the Group 1. This keypad has user Group 1 only
- Key in "5" that is the Command Code for making a deletion here
- Key in the User ID that stored the User PIN, the lost EM card or the EM Card+ User PIN
- Press the # key. Two-beep confirms a valid entry and the PIN and/or Card in that User ID is cleared

ii) Delete an EM Card

(a) (b) (c) (d)

- Key in the User Group that the EM Card belongs to. "1 0" for the Group 1. This keypad has user Group 1 only
- Key in "5" that is the Command Code for making a deletion here
- Put the EM card close to the reader. One-beep confirms the reading. Read the Card only also makes a valid deletion to the Card working with the Common User PIN or the Secondary User PIN
- Press the # key. Two-beep confirms a valid entry. The EM Card in that User ID is cleared. Key in the User ID is not required.

6) Example 6 – Clear The Whole Group of Users :

Whole group of users including the PINs and Cards can be cleared with the following command.

(a) (b) (c)

- The User Group 1 – "10" is selected to be cleared. This keypad has user Group 1 only
- Key in the Group Deletion Command, **0 9 9 9**
- Confirm the deletion with #. All the User PINs and Cards in the Group 1 are cleared. It takes few seconds to a minute to complete depending on the data stored.

VISITOR CODES (FOR OUTPUT 1 ONLY)

(Location 40)

The Visitor Codes are the temporary user codes for operating of the **Output 1** (mainly for door strike in access control). They can be programmed as “**One Time Codes**” or “**Codes with Time Limit**”. The Visitor Codes will be cleared automatically after use if they are one time codes, or, when the allowed time expires.



VISITOR ID

50 Visitor IDs for storing the codes. They are represented by a Two-digit ID Number of [0][1] to [5][0].

[0][9][9][9] = **Clear all the Visitor Codes from Location 40.** Please see the Programming example below for the details.

VALID PERIOD

The codes in this box **MUST** be two digits and they represent the time of the operation.

[0][0] --- **One Time Code**

One Time Code has no time limit but it can only be used for ONCE. It is cleared by the system automatically after use.

[0][1]-[9][9] --- **Time Limit in Hour(s)**

The Visitor Code can be set with the valid time limit of 1 Hour to 99 Hours with a two-digit number of 01 to 99. The visitor code is cleared by the system when the time limit reaches.

VISITOR CODES

- When a new Visitor Code is put in the same Code box, the old code is replaced.
- The Visitor Codes can be 4-8 digits for the Manual Mode code entry.
- The Visitor Codes **MUST** be in the same digit length with the Master Code for Auto Mode code entry.

NOTE: All Visitor Codes will be cleared after power down to prevent extension/confusion of their valid time limit.

EXAMPLES:

Example 1: Set a “One Time Visitor Code” with the number of “1 2 6 8” for the Output 1

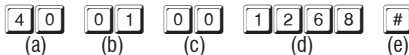

(a) Visitor Code Programming, (b) The Visitor ID, (c) An One Time Code, (d) The Visitor Code, (e) Entry Confirmation

Example 2: Set a “Visitor Code” with the number of “1 3 7 8” that is valid for three hours for the Output 1

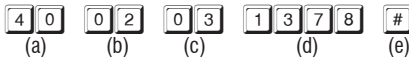

(a) Visitor Code Programming, (b) The Visitor ID, (c) Valid for 3 Hours, (d) The Visitor Code, (e) Entry Confirmation

Example 3: Delete a “Visitor Code” from Visitor ID [0][2] in the memory

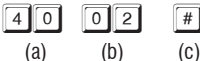

(a) Visitor Code Programming, (b) The Visitor ID, (c) Delete Confirmation

Example 4: Clear all “Visitor Codes” from Location [4][0]

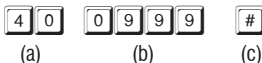

(a) Visitor Code Location, (b) The Deletion Command Code, (c) Confirmation, all Visitor Codes are cleared

CONFIGURATION OF THE OUTPUT MODES OF OUTPUT 1

(Location 51)

The relay output of this keypad is programmable for Start/Stop or Timing modes. Apart from the door access control, alarm arm-disarm control, it is also an **universal timer for automatic operator in industry** with its 99,999 seconds (over 24 hours) programmable timer.

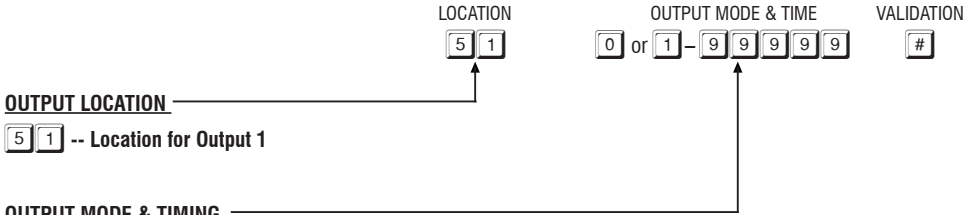

5 1 -- Location for Output 1

0 – Start /Stop Mode (Toggle)

The number 0 sets the output to the **Start / Stop mode**. The output **Starts** when an User PIN and/or Card is entered/read; the output **Stops** when an User PIN and/or Card is entered/read again.

1-99999 Seconds Momentary --- (Default -- Momentary 5 Seconds)

The output can be set in **Momentary Mode** with the time of 1 second to 99,999 seconds. The output will reset automatically when the time expires OR it can be **RESET manually at anytime with the Super User Code** before the end of the time.

Example : Reset Output 1 -- SUPER USER CODE # 1 ----- Output 1 resets

PERSONAL SAFETY AND SYSTEM LOCK-OUT

(Location 60)



The Options are represented by their Mode Numbers in programming. They are described below:

1 --- After 10 successive false Card/User Code trials, the keypad locks during 60 seconds. -- (Default)

5 - 1 0 --- Selection of after 5 to 10 successive Card/User Code trials, the keypad locks during 15 minutes. The keypad can be reset to release the lock-out with the "Super User Code" in the following way.

Example : Release the lock-out -- SUPER USER CODE # 9

0 0 --- Disappearance of all the above lock-out securities.

USER PIN ENTRY MODE – Auto or Manual

(Location 70)

LOCATION ENTRY MODES VALIDATION
[7][0] [1] or [2] [#]

USER PIN ENTRY MODES

Two modes 1 and 2 are available for User PIN entry options. The **EM Card is always in Auto Entry Mode** and is not affected by the selection here.

[1] --- Auto Entry Mode

Auto Entry Mode requires no pressing of the [#] key following the User PIN for code checking.

In the Auto Entry Mode, the **User PINs MUST be set in the same digit length of the Master Code** (For example, if the Master Code is 5 digits, then all User PINs must be in 5 digits as well. All other User PINs not in 5 digits become invalid). When the number of digits reaches, the system will check the User PIN automatically. Good for high traffic access control.

[2] --- Manual Entry Mode – (Default)

Manual Entry Mode always requires the [#] key following of the User PIN for code checking. The User PINs can be **4-8 digits arbitrary** and they are **NOT** required to be in the same digit length of the Master Code. Manual Entry increases the level of security in the code trial by the unauthorized people.

PACIFIER TONES ON-OFF SELECTION

(Location 71)

LOCATION FUNCTION MODES VALIDATION
[7][1] [1] or [0] [#]

PACIFIER TONES ON-OFF MODES

The Pacifier Tone is the Beep Tones from the keypad, which include the tones of Successful Key entry (1 beep), the Output Operation Announcer (2 beeps or 1 long beep) and the Unsuccessful User Code/Card entry (5 beeps).

NOTE :

The beeps for the Warning and the Power-up Delay do not belong to pacifier tones and can not be set to OFF.

[1] --- Pacifier Tone ON – (Default)

All the Pacifier Tones available from the keypad are enabled. They are the response tones indicating the operation status of the keypad after the Card/User Code is entered.

[0] --- Pacifier Tone OFF

All the Pacifier Tones are OFF. Good for place needs for a silent environment.

OUTPUT OPERATION ANNOUNCER

(Location 72)

LOCATION FUNCTION MODES VALIDATION
[7][2] [1] or [0] [#]

OUTPUT OPERATION ANNOUNCER

The announcer gives notification beep to the users and the visitors on the operation status of the outputs. There are two notification modes available for the selection. The notification is also OFF while the Pacifier Tone OFF mode in the Location 71 is selected.

[1] --- 1 Second Long Notification -- (Default)

1 second notification beep is given when the output relay is activated with a valid Card/Code or Egress Button. It is prepared to notify the person outside the door when the lock is released and the door can be opened. It is good for the door lock device gives no sound when it activates, such as a magnetic lock.

[0] --- 2 Short Beeps Notification

2 short beeps notification is given when the output is activated with a valid Card/Code.

STATUS LED FLASHING ON-OFF DURING STANDBY

(Location 73)

LOCATION FUNCTION MODES VALIDATION
[7][3] [1] or [0] [#]

STANDBY FLASHING ON-OFF

Some people find the flashing light of the status LED (the amber LED) is annoying during the keypad is on standby, especially at the night time. The standby flashing can be ON-OFF with the setting here.

[1] --- Standby Flashing ON -- (Default)

The Status LED gives Standby Flashing all the time during the keypad is on standby. It also gives all the light indications showing the operation status of the system.

[0] --- Standby Flashing OFF

The Standby Flashing is disabled but it does not affect the system status indications. All the light indications from it are unchanged.

INTELLIGENT EGRESS BUTTON – AN UNIQUE FEATURE OF A CONTEMPORARY KEYPAD

Most of the keypads for access control are just for controlling of “Going In” from outside. It is not enough for today’s access control systems. In fact, controlling of “Going Out” is also very important in many public passage areas. They are not allowed to use locks or digital keypads for stopping of “Going Out” due to safety reasons. Such as hospitals, kindergartens, elderly homes, convenient stores, emergency exits etc.. The wardens, teachers, shopkeepers and the guards are always required to keep an eye on people to prevent unattended leaving, shoplifting, and illegal use of the emergency exits.

The Intelligent Egress Button can be programmed to do something to get the attention of the person on duty before the door is opened. The button offers programmable egress delay, delay with warning, holding button required for the delay, momentary button contact with warning for the delay.

Location 90 is the place for setting the desired functions for the Egress Button.

The functions programmed to the Egress Button do not affect the normal operation of the system with its keypad. For the safety consideration, the operation of the keypad with PIN, Code or Card is always in the first priority to give instant action to the output relay 1 for door strike.

It is **NOT** required to program the Egress Button with the special function in normal use. Just leave it on its default values.

WHERE AND WHY “GOING OUT” NEEDS ATTENTION

Examples for some areas may need an Intelligent Egress Button:

Hospital:

Some of the patients are not allowed to leave the ward without doctor’s permission. An egress button with exit delay and warning beeps will help the nurse or warden to get the attention to the door when the egress button is pressed. Further setting of the egress button with holding contact for the delay even gives higher level of security to a controlled door.

Kindergarten:

Young children are always active. Some of them may be willing to go out to explore their ways of playing. For safety reason, teachers have to watch all of them in the attended area. Leaving school alone without the companion of parents or teacher is dangerous to the young children. An egress button with delay and warning beeps will be helpful to prevent the children trying to go out without getting the attention of the teacher.

Elderly Home:

Elderly needs constant attention and care. Some old people have poor memory. They may forget the way to come back if they leave home alone. An egress button with delay and warning beep will easily get the attention of the warden before the door is open.

Convenient Store:

Most of the convenient stores have just only one or two shopkeepers on duty. They are usually the cashier. Shoplifting may easily happen while the shopkeeper is busily serving customers at the cashier desk. A holding contact egress button with delay and warning beeps may help to stop most of the shoplifting. As the thief knows that he is gotten attention by the shopkeeper before the door is open.

High Traffic Passage:

A short buffer time may be necessary for opening a door outward after pressing the egress button for those exits open to a high traffic passage. An egress button with short delay and warning beeps helps the user to pay attention to the people passing by to prevent hitting them when the door is pushed outward.

Emergency Exit:

Emergency Exit is not open to the public for daily use. It is for emergency case only. It is usually closed and watched by the security guards. The egress button of this keypad can be programmed to offer exit delay with warning beeps when the door is forced to open or the door is open after the exit delay expired. It is an useful tool to get the attention of the person on duty.



CONFIGURATIONS OF THE EGRESS WARNING AND ALARM

Key in the number to enable 1, 2, 4 or 5 configurations described below:

- [1] --- Momentary Contact Mode without Warning -- (Default)**
 - Press the Button once. No warning or alarm is given during Egress Delay.
 - Good for silent area. The people have to wait for the door open until the delay time reaches.
- [2] --- Momentary Contact Mode with Warning Beep**
 - Press the Button once. The system gives Warning Beeps during the Egress Delay.
 - Good for the place required attention. The keypad beeps during the people are waiting for the door open.
- [4] --- Holding Contact Mode without Warning**
 - Press and hold the Button. No warning or alarm is given during the Egress Delay.
 - Good for the silent area. The people require to press & hold the button until the delay time reaches for the door open.
- [5] --- Holding Contact Mode with Warning Beep**
 - Press and hold the Button. The system gives Warning Beeps during Egress Delay.
 - Good for the place required attention. The keypad beeps while the button is kept pressed during the people are waiting for the door open.

EGRESS DELAY TIMER

- [0] --- No Delay – (Default)**
Output 1 activates instantly (the door is released instantly) when the Egress Button is pressed.
- [1] - [9][9] --- Egress Delay Timing**
Put any number of 1 to 99 into the box to enable the Egress Delay. The number is the time in second, which starts to count when the Egress Button is pressed. Output 1 activates (the door is released) when the delay time reaches.

NOTE:

- 1) Momentary Contact** -- The Egress Delay starts to count when the egress button is momentarily pressed. Output 1 activates automatically (door is released) when the delay time reaches.
- 2) Holding Contact** -- The user **MUST** hold the egress button in contact for the whole period of the Egress Delay time until Output 1 activates. If the egress button is released before the end of the Egress Delay, the timer will stop to count and reset.
- 3)** The Egress Delay does not affect the operation of the User PINs/Cards for Output 1. The User PINs/Cards always give INSTANT action.

EXAMPLES:

Example 1: Set Egress Button in Momentary contact 5 seconds with delay & warning beep

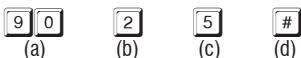

- (a) Egress function programming, (b) Momentary contact with warning, (c) Delay time of 5 seconds to release door, (d) Entry confirmation

Example 2: Set Egress Button in Holding contact of 10 seconds with warning beep

9 0

(a)

5

(b)

1 0

(c)

#

(d)

(a) Egress function programming, (b) Holding contact mode with warning, (c) Holding time of 10 seconds to release door, (d) Entry confirmation

Example 3: Set Egress Button in Momentary contact without delay (This is the default setting)

9 0

(a)

1

(b)

0

(c)

#

(d)

(a) Egress function programming, (b) Momentary contact without delay, (c) Release door instantly, (d) Entry confirmation

CLOSE THE PROGRAMMING MODE

(* *)

Always close programming mode with * * to set system back to normal Operation after programming.

VALIDATION

* *

----- System is back to normal operation mode

THE OPERATION MODES

(Location 94)

Four operation modes are available for the selection. The codes are **0**, **1**, **2** and **3**.



WIEGAND OUTPUT AT KEYPAD OPERATION MODE

0 --- Stand Alone Keypad Mode -- (Default)

The system provides full functions to operate its outputs.

1 --- Card & Code Reader Mode (Not Available in this model)

2 --- Master Keypad of Split-Decoded Mode

The Master keypad will transfer all the programmed feature data (except the user PINs, Codes and Cards data) to the Access Controller (decoder) right after it exits the programming mode. A Split-decoded keypad system needs at least one Master keypad and one Access Controller to work.

3 --- Slave Keypad of Split-Decoded Mode

No feature data is transferred to the Access Controller (decoder) from the Slave keypad. It takes the same feature data from the Master keypad to operate. The Slave keypad(s) is for a Split-Decoded system that needs more than one keypads for operation convenience.

NOTE:

- a) Do not set more than one keypads in Master mode in a Split-Decoded system. Otherwise, the data will be confused.
- b) Each keypad in Split-Decoded mode can be programmed independently with its own user PINs, Codes and Cards. The PINs, Codes and Cards can be repeatedly used in other keypads in the same system.

THE APO DATA I/O PORT -- FOR SETTING UP A SPLIT-DECODED KEYPAD

The information here is for setting up the keypad unit with an optional "Digital Keypad Access Controller DA-2800" to make up a high security Split-decoded Keypad system only. It is **NOT** required for the keypad in **Stand Alone** operation.

Split-decoded Keypad System

Most of the general purpose keypads on the market are self-contained systems for stand alone operation. It controls the appliance(s) directly with its output relay contact(s); such as the electric lock in an access control system. The electric lock is connected to the keypad that is installed outside the house. The thief can open the door without a code or card but just open the keypad box and make contact to the output relay terminal. It is a safety drawback in security.

The high security systems are usually operating in the Split-decoded mode that combines an outside unit for card reading and code entry; and a control panel or a decoder unit installing in a secure closet inside the house. The outside unit and the inside unit communicate in digital data with each other. All the commands are in digital codes, the thief can do nothing to the inside unit even the outside unit is opened in sabotage. This design philosophy confirms high security to the area protected, but not just relying on the protection of the keypad with the outer box and two screws.

The keypad unit comes with a data I/O (data input and output) port for the connection with the APO's Access Controller DA-2800 for Split-decoded operation to up-grade its security level. Once the keypad unit is connected with the controller, all the commands from it will be faithfully decoded by the decoder. The input & output control functions available from the keypad are now all transferred to the controller. The keypad's role is just a card reader and/or a keyboard for code entry. The link up of the two units is very simple. It is just one wire (The White Wire) for the I/O ports and a common grounding wire (The Black Wire) for the two units. The I/O port provides the data in the proprietary APO format. It **ONLY** works with the DA-2800.

The Optional DA-2800 Controller --- Introduction

The DA-2800 controller unit is compatible with the keypad unit. Maximum 3 keypads can be connected in parallel to it. It decodes the data faithfully from the keypads even each of them have different settings of their own. The only criterion for multi-keypad link-up is all the keypads are set with the same Master Code and is read by the controller while it is in the link-up mode.

Apart from the decoding function to follow the features from the keypad(s), the DA-2800 is also an independent 4-channel RF remote controller to operate its 3 output relays and the built-in door chime. The DA-2800 is an ideal device working independently in the RF remote control areas, such as door lock strike in access control, garage door opening control, alarm arm-disarming control and automatic operator control etc.

The keypad unit is up graded to a Tri-Tech system after in connection with the DA-2800 controller. The system accepts EM Cards, User PINs and the RF Remote Keys in access control.

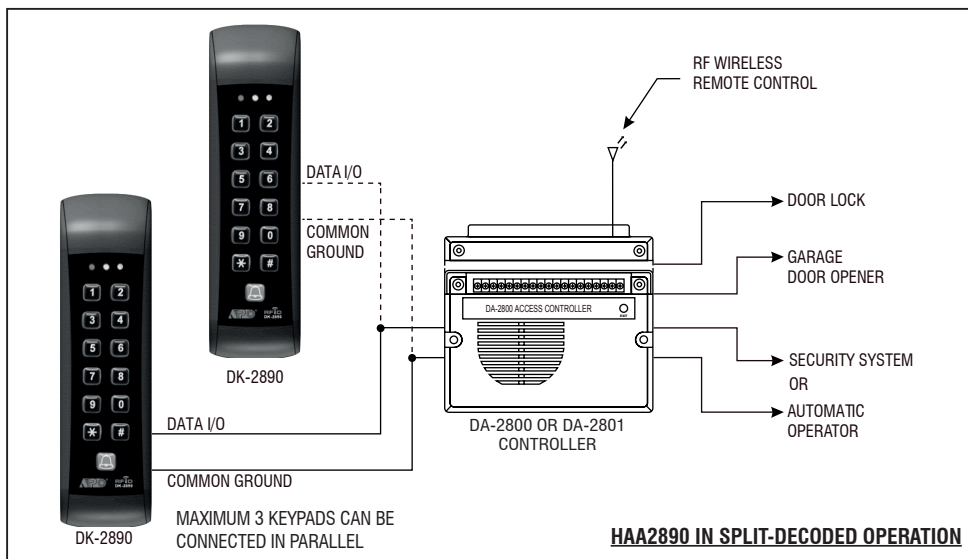

The User Manual of the DA-2800 provides the operation details of the system on decoding controller mode and independent operation mode. Please contact your local agent if purchase of the DA-2800 Controller is required.
REMARK: DA-2801 is the simplified version of the DA-2800 without wireless remote control function.

PROGRAMMING SUMMARY CHART

LOCATION	FUNCTION	ENTRY LIMITS & CODE OPTIONS	CODE ENTRY	FACTORY DEFAULT
0 1	Master Code	4-8 Digits	<input type="text" value="0"/> <input type="text" value="1"/> <input type="text" value="MASTER CODE"/> <input type="text" value="#"/>	NIL
0 2	Super User PIN	4-8 Digits	<input type="text" value="0"/> <input type="text" value="2"/> <input type="text" value="SUPER USER PIN"/> <input type="text" value="#"/>	NIL
0 3	Common User PIN for O/P 1	4-8 Digits	<input type="text" value="0"/> <input type="text" value="3"/> <input type="text" value="COMMON USER PIN 1"/> <input type="text" value="#"/>	NIL
1 0	User PINs / Cards for O/P 1	CODE 1 – MEDIA: 1---EM Card 2---Private User PIN 3---EM Card+Sec User PIN 4---EM Card+Com User PIN 5---Deletion of User PIN CODE 2 – USER ID: 000-999---Group 1 CODE 3 – USER PINs / Cards: 4-8 Digits / Cards	<input type="text" value="1"/> <input type="text" value="0"/> <input type="text" value="CODE1"/> <input type="text" value="CODE2"/> <input type="text" value="CODE3"/> <input type="text" value="#"/>	NIL
4 0	Visitor Codes	CODE 1 – VISITOR ID: 01-50 CODE 2 – VALID PERIOD: 00---One Time 01-99 Hours CODE 3 – VISITOR CODE: 4-8 Digits	<input type="text" value="4"/> <input type="text" value="0"/> <input type="text" value="CODE1"/> <input type="text" value="CODE2"/> <input type="text" value="CODE3"/> <input type="text" value="#"/>	NIL
5 1	O/P Mode for O/P 1	OUTPUT MODE & TIME: 0--- Start / Stop 1---99999 Seconds, Momentary	<input type="text" value="5"/> <input type="text" value="1"/> <input type="text" value="O/P MODE & TIME"/> <input type="text" value="#"/>	5 Seconds
6 0	Personal Safety & Lock-out	LOCK-OUT CODE: 1---10 Trial, Lock-out 60 Sec. 5-10---5-10 Trial, Lock-Out 15 Minutes 00---No Lock-out	<input type="text" value="6"/> <input type="text" value="0"/> <input type="text" value="LOCK-OUT CODE"/> <input type="text" value="#"/>	Code = 1, 10 Trials, Lock-out 60 Seconds
7 0	PIN Entry Mode	ENTRY MODE: 1---Auto Mode 2---Manual Mode	<input type="text" value="7"/> <input type="text" value="0"/> <input type="text" value="ENTRY MODE"/> <input type="text" value="#"/>	Mode = 2, Manual Mode
7 1	Pacifier Tone ON-OFF	FUNCTION MODE: 0---OFF 1---ON	<input type="text" value="7"/> <input type="text" value="1"/> <input type="text" value="FUNCTION MODE"/> <input type="text" value="#"/>	Mode = 1, Pacifier Tone ON
7 2	Output Announcer		<input type="text" value="7"/> <input type="text" value="2"/> <input type="text" value="FUNCTION MODE"/> <input type="text" value="#"/>	Mode = 1 Announcer ON
7 3	Standby LED Flashing		<input type="text" value="7"/> <input type="text" value="3"/> <input type="text" value="FUNCTION MODE"/> <input type="text" value="#"/>	Mode = 1, Flashing On
9 0	Egress Delay Warning	CODE 1 – FUNCTION MODE: 1---Momentary, No warning 2---Momentary, with warning 4---Hold Contact, No warning 5---Hold Contact, with warning CODE 2 – DELAY TIME: 0---No Delay 1-99 Seconds	<input type="text" value="9"/> <input type="text" value="0"/> <input type="text" value="CODE 1"/> <input type="text" value="CODE 2"/> <input type="text" value="#"/>	Mode = 1 Momentary, No warning TIME = 0 No Delay

9 4	Operation Mode	OPERATION MODES 0---Stand Alone Keypad–Valid Codes & Cards Only 1---Reader–All Codes & Cards 2---Master Keypad–Valid Codes & Cards only 3---Slave Keypad–Valid Codes & Cards only	<input type="text" value="9"/> <input type="text" value="4"/> <input type="text" value="OPERATION MODE"/> <input type="text" value="#"/>	Mode = 0 Keypad Mode
-----	----------------	--	--	----------------------

SYSTEM CODES	FUNCTION	CODE ENTRY	RESULTS
0 0 0 0	Factory Set Master Code for User to set system in programming Mode at the first time. THIS IS NOT A PERMANENT SYSTEM CODE & IT IS CHANGED IF A NEW MASTER CODE IS PROGRAMMED.	<input type="text" value="0"/> <input type="text" value="0"/> <input type="text" value="0"/> <input type="text" value="0"/> <input type="text" value="*"/> <input type="text" value="*"/> OR <input type="text" value="NEW MASTER CODE"/> <input type="text" value="*"/> <input type="text" value="*"/>	System in Programming Mode
9 9 9 9	REFRESH CODE -- Refresh the system and set all its function back to default values.	<input type="text" value="9"/> <input type="text" value="9"/> <input type="text" value="9"/> <input type="text" value="9"/> <input type="text" value="#"/>	All programmed data are cleared and back to the default values except the Master Code
8 0 8 0	DAP CODE-- Direct access to programming mode. Valid only in the power-up delay period	<input type="text" value="8"/> <input type="text" value="0"/> <input type="text" value="8"/> <input type="text" value="0"/> <input type="text" value="#"/>	System in Programming Mode
0 9 9 9	USER PINs / Codes / Cards whole group clearance Code – Key in the Code to clear all the users in the Location LOCATIONS: 10--- User Group 1 40--- Vistor Group	<input type="text" value="LOCATION NO."/> <input type="text" value="0"/> <input type="text" value="9"/> <input type="text" value="9"/> <input type="text" value="9"/> <input type="text" value="#"/>	Whole group of users in the selected location are cleared
* *	Exit Programming Code	<input type="text" value="*"/> <input type="text" value="*"/>	The system back to normal opration after programming

APPLICATION EXAMPLE

BASIC WIRINGS OF A STAND ALONE DOOR LOCK

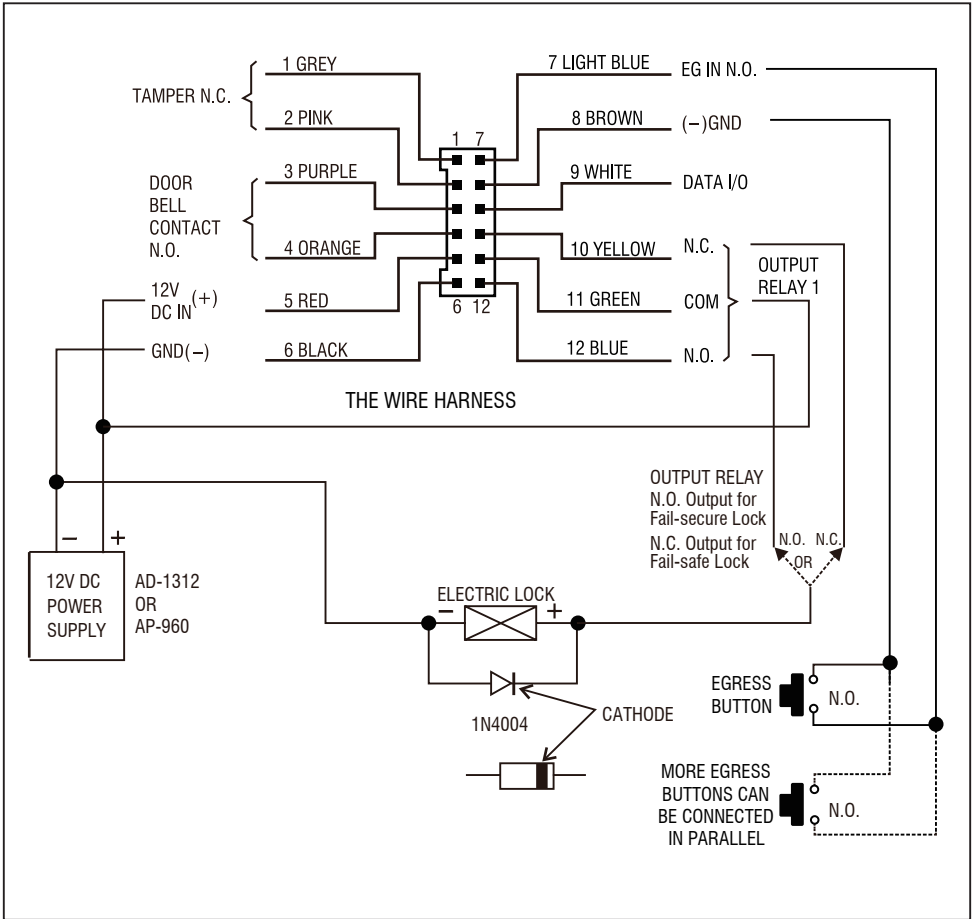

NOTE:

- Connect the 1N4004 as close as possible to the lock in parallel with the lock power terminals of the lock to absorb the back EMF to prevent it from damaging the keypad. The 1N4004 is not required if the electric lock is AC operated.
- To avoid Electro-Static-Discharge from interfering with the operation of the keypad, always ground the (-) terminal of the keypad to earth.

APPLICATION HINTS FOR THE AUXILIARY TERMINALS

(A) TAMPER N.C.

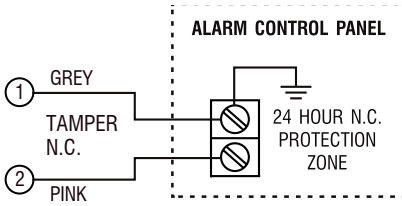

The tamper switch is Normally Closed while the keypad is secured on box. It is open when the keypad cover is removed from the box. To prevent sabotage, connect these terminals in series with a 24 hour N.C. protection zone of an alarm system if required.

(B) DOOR BELL N.O.

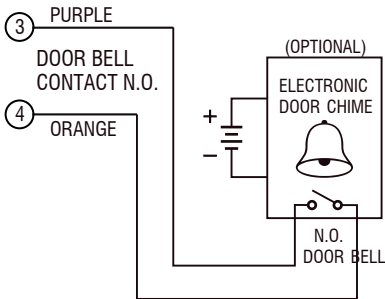

The connection of the Door Bell is optional. The door bell contact on the keypad is prepared for triggering of a low power door chime only. DO NOT use it as a high voltage power path for a door bell. The maximum power rating of the contact is 24V DC/1 Amp.

RED Declaration of Conformity

Hereby, Velleman NV declares that the radio equipment type HAA2890 is in compliance with Directive 2014/53/EU.

The full text of the EU declaration of conformity is available at the following internet address:
www.velleman.eu.

Velleman® Service and Quality Warranty

Since its foundation in 1972, Velleman® acquired extensive experience in the electronics world and currently distributes its products in over 85 countries.

All our products fulfil strict quality requirements and legal stipulations in the EU. In order to ensure the quality, our products regularly go through an extra quality check, both by an internal quality department and by specialized external organisations. If, all precautionary measures notwithstanding, problems should occur, please make appeal to our warranty (see guarantee conditions).

General Warranty Conditions Concerning Consumer Products (for EU):

- All consumer products are subject to a 24-month warranty on production flaws and defective material as from the original date of purchase.
- Velleman® can decide to replace an article with an equivalent article, or to refund the retail value totally or partially when the complaint is valid and a free repair or replacement of the article is impossible, or if the expenses are out of proportion.

You will be delivered a replacing article or a refund at the value of 100% of the purchase price in case of a flaw occurred in the first year after the date of purchase and delivery, or a replacing article at 50% of the purchase price or a refund at the value of 50% of the retail value in case of a flaw occurred in the second year after the date of purchase and delivery.

• Not covered by warranty:

- all direct or indirect damage caused after delivery to the article (e.g. by oxidation, shocks, falls, dust, dirt, humidity...), and by the article, as well as its contents (e.g. data loss), compensation for loss of profits;
- consumable goods, parts or accessories that are subject to an aging process during normal use, such as batteries (rechargeable, non-rechargeable, built-in or replaceable), lamps, rubber parts, drive belts... (unlimited list);
- flaws resulting from fire, water damage, lightning, accident, natural disaster, etc....;
- flaws caused deliberately, negligently or resulting from improper handling, negligent maintenance, abusive use or use contrary to the manufacturer's instructions;
- damage caused by a commercial, professional or collective use of the article (the warranty validity will be reduced to six (6) months when the article is used professionally);
- damage resulting from an inappropriate packing and shipping of the article;
- all damage caused by modification, repair or alteration performed by a third party without written permission by Velleman®.
- Articles to be repaired must be delivered to your Velleman® dealer, solidly packed (preferably in the original packaging), and be completed with the original receipt of purchase and a clear flaw description.
- Hint: In order to save on cost and time, please reread the manual and check if the flaw is caused by obvious causes prior to presenting the article for repair. Note that returning a non-defective article can also involve handling costs.
- Repairs occurring after warranty expiration are subject to shipping costs.
- The above conditions are without prejudice to all commercial warranties.

The above enumeration is subject to modification according to the article (see article's manual).
