

Gegevensblad | Artikelnummer: 221-615

COMPACT Splicing Connector; for all conductor types; max. 6 mm²; 5-conductor; with levers; transparent housing; Surrounding air temperature: max 85°C (T85); 6,00 mm²; transparent

www.wago.com/221-615

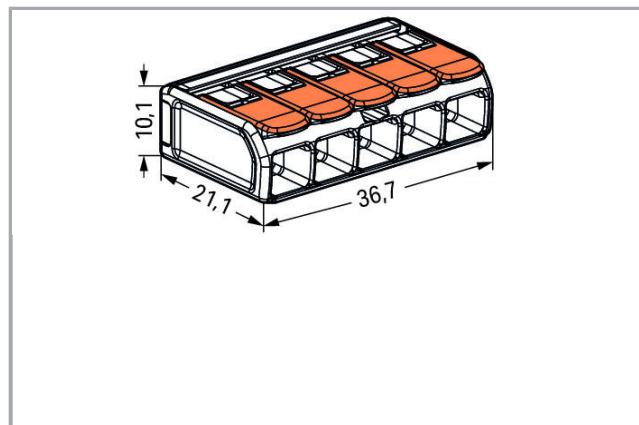
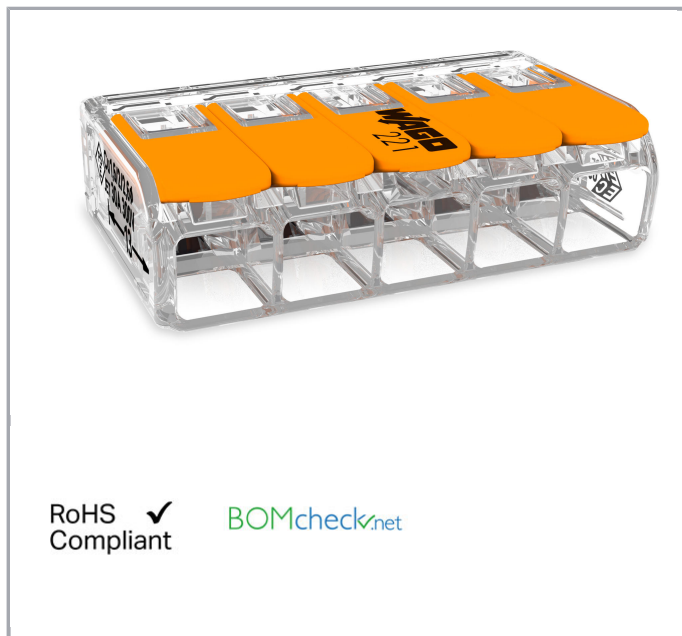

RoHS Compliant

[BOMcheck.net](https://www.bomcheck.net)



Artikelbeschrijving

Your Benefits:

- Ease of use – pull the lever up, insert a conductor and push the lever back down
- Available as 2-, 3- and 5-wire connectors
- Easily terminate conductors from 0.5 to 6 mm²

Wijzigingen voorbehouden. Let ook op de verdere productdocumentatie!

WAGO BeLux nv
Excelsiorlaan 11
1930 Zaventem
Telefoon.: +32 (0)2 717 90 90 | Fax: +32 (0)2 717 90 99
E-mail: info-be@wago.com | Web: www.wago.be

Hebt u vragen over onze producten?
U kunt ons telefonisch bereiken op het nr. +32 (0) 2 7179090.



- Connection of all conductor types
- Time savings for installers and device manufacturers
- Quickly install devices with higher levels of power consumption
- Safely install long cable runs with larger conductor cross sections
- Mounting carrier for installation conforms to standards
- Custom carriers are possible

Safety information 1:

in grounded power lines

Gegevens**Electrical data****Ratings per IEC/EN 60664-1**

Ratings per	EN 60664
Nominal voltage (II/2)	450 V
Rated surge voltage (II/2)	4 kV
Rated current	41 A
Legend (ratings)	(II / 2) \triangleq Overvoltage category II / Pollution degree 2

Approvals per UL 1059

Rated voltage UL (Use Group C)	600 V
Rated current UL (Use Group C)	30 A

Connection data

Connection technology	CAGE CLAMP [®]
Actuation type	Lever
Connectable conductor materials	Copper
Nominal cross-section	6 mm ²
Solid conductor	0.5 ... 6 mm ² / 20 ... 10 AWG
Stranded conductor	0.5 ... 6 mm ² / 20 ... 10 AWG
Fine-stranded conductor	0.5 ... 6 mm ² / 20 ... 10 AWG
Strip length	12 ... 14 mm / 0.47 ... 0.55 inch
Total number of connection points	5
Total number of potentials	1
Wiring type	Side-entry wiring

Wijzigingen voorbehouden. Let ook op de verdere productdocumentatie!

WAGO BeLux nv
 Excelsiorlaan 11
 1930 Zaventem
 Telefoon.: +32 (0)2 717 90 90 | Fax: +32 (0)2 717 90 99
 E-mail: info-be@wago.com | Web: www.wago.be

Hebt u vragen over onze producten?
 U kunt ons telefonisch bereiken op het nr. +32 (0) 2 7179090.

Geometrical Data

Width	36.7 mm / 1.445 inch
Height	10.1 mm / 0.398 inch
Depth	21.1 mm / 0.831 inch

Material Data

Color	transparent
Flammability class per UL94	V2
Color of actuator	orange
Weight	7,1 g

Environmental Requirements

Surrounding air temperature (operation)	85 ... 85 °C
Continuous operating temperature	105 ... 105 °C
Temperature marking per EN 60998	T85

Commercial data

Packaging type	BOX
Country of origin	CH
GTIN	4055143715478
Customs tariff number	85369010000

Vergunningen / certificaten

Country specific Approvals

Logo	Vergunning	Norm	Certificaatsnaam
	KEMA/KEUR DEKRA Certification B.V.	EN 60998	71-105677

Ship Approvals

Logo	Vergunning	Norm	Certificaatsnaam
	ABS American Bureau of Shipping	EN 60998	18-HG1755093-PDA
	DNV GL Det Norske Veritas, Germanischer Lloyd	EN 60998	TAE000015T

Wijzigingen voorbehouden. Let ook op de verdere productdocumentatie!

WAGO BeLux nv
Excelsiorlaan 11
1930 Zaventem
Telefoon.: +32 (0)2 717 90 90 | Fax: +32 (0)2 717 90 99
E-mail: info-be@wago.com | Web: www.wago.be

Hebt u vragen over onze producten?
U kunt ons telefonisch bereiken op het nr. +32 (0) 2 7179090.





LR
Lloyds Register

EN 60998

04/20013 (E8)





UL-Approvals

Logo	Vergunning	Norm	Certificaatsnaam
 LISTED GROUNDING EQUIP 648A	UL Underwriters Laboratories Inc.	UL 467	E201573
 LISTED WIRE CONNECTOR 667F	UL Underwriters Laboratories Inc.	UL 486C	E69654

Relevante producten

Mounting adapter

	Artikelnummer: 221-510 Mounting carrier; 221 Series - 6 mm ² ; for DIN-35 rail mounting/screw mounting; orange	www.wago.com/221-510
	Artikelnummer: 221-510/000-006 Mounting carrier; 221 Series - 6 mm ² ; for DIN-35 rail mounting/screw mounting; blue	www.wago.com/221-510/000-006
	Artikelnummer: 221-510/000-053 Mounting carrier; 221 Series - 6 mm ² ; for DIN-35 rail mounting/screw mounting; dark gray-yellow	www.wago.com/221-510/000-053

Downloads

Documentation

Bid Text

221-615 GAEB X81 - Datei	19-feb-2019	xml 3,6 kB	Download
221-615 GAEB docx - Datei	23-jan-2019	docx 15,8 kB	Download

Wijzigingen voorbehouden. Let ook op de verdere productdocumentatie!

WAGO BeLux nv
 Excelsiorlaan 11
 1930 Zaventem
 Telefoon.: +32 (0)2 717 90 90 | Fax: +32 (0)2 717 90 99
 E-mail: info-be@wago.com | Web: www.wago.be

Hebt u vragen over onze producten?
 U kunt ons telefonisch bereiken op het nr. +32 (0) 2 7179090.

Additional Information

Technical explanations

3-apr-2019

pdf
2,1 MB

[Download](#)

CAD/CAE-Data

CAD data

2D/3D Models 221-615

[URL](#)

[Download](#)

CAE data

ZUKEN Portal 221-615

[URL](#)

[Download](#)

Gebruiksaanwijzingen

Conductor termination

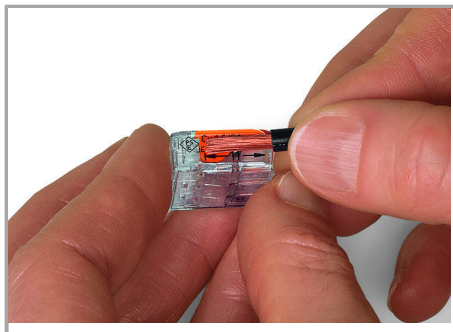

Strip conductor to 11 mm (0.43 inch).

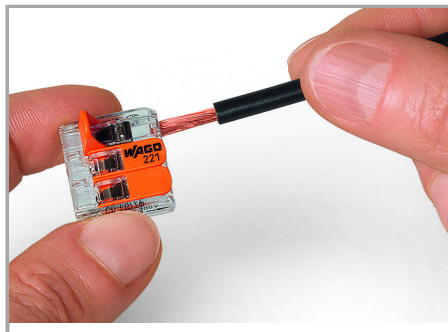

Termination: Lift the lever to open the clamping unit and insert a stripped conductor.

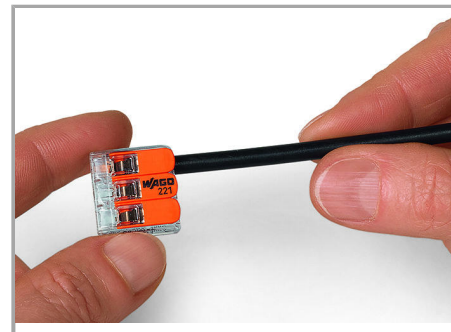

Then, lower the lever to close the clamp.

Application

Wijzigingen voorbehouden. Let ook op de verdere productdocumentatie!

WAGO BeLux nv
Excelsiorlaan 11
1930 Zaventem
Telefoon.: +32 (0)2 717 90 90 | Fax: +32 (0)2 717 90 99
E-mail: info-be@wago.com | Web: www.wago.be

Hebt u vragen over onze producten?
U kunt ons telefonisch bereiken op het nr. +32 (0) 2 7179090.

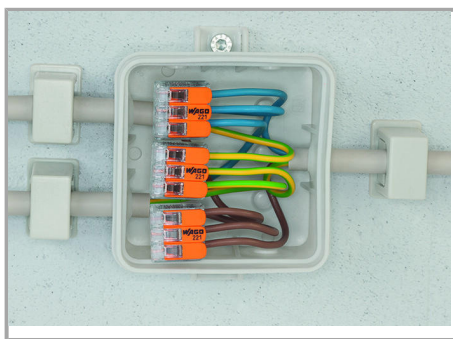

Wiring fine-stranded conductors in a junction box.

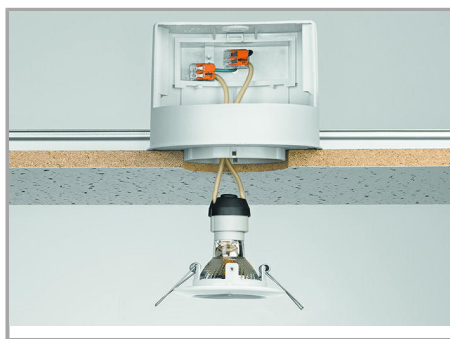

Custom low-voltage lighting system



Lighting distribution in ceiling canopy



Pendant light connection in suspended ceilings

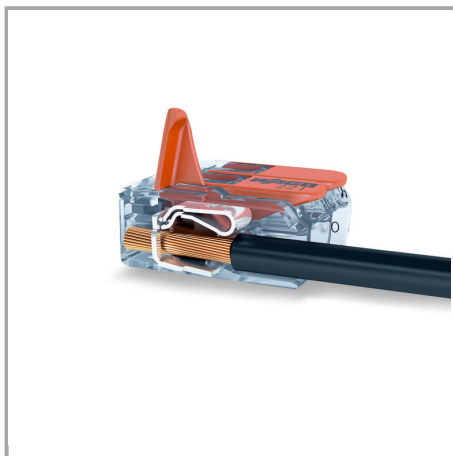

COMPACT Splicing Connectors for All Conductor Types, 4 mm² (12 AWG), 221 Series

Wijzigingen voorbehouden. Let ook op de verdere productdocumentatie!